

HP8657A
HP8657B
Synthesized RF Signal Generators
(Including Options 001, 002 and 003)
Operating and Calibrating Guide

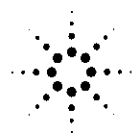
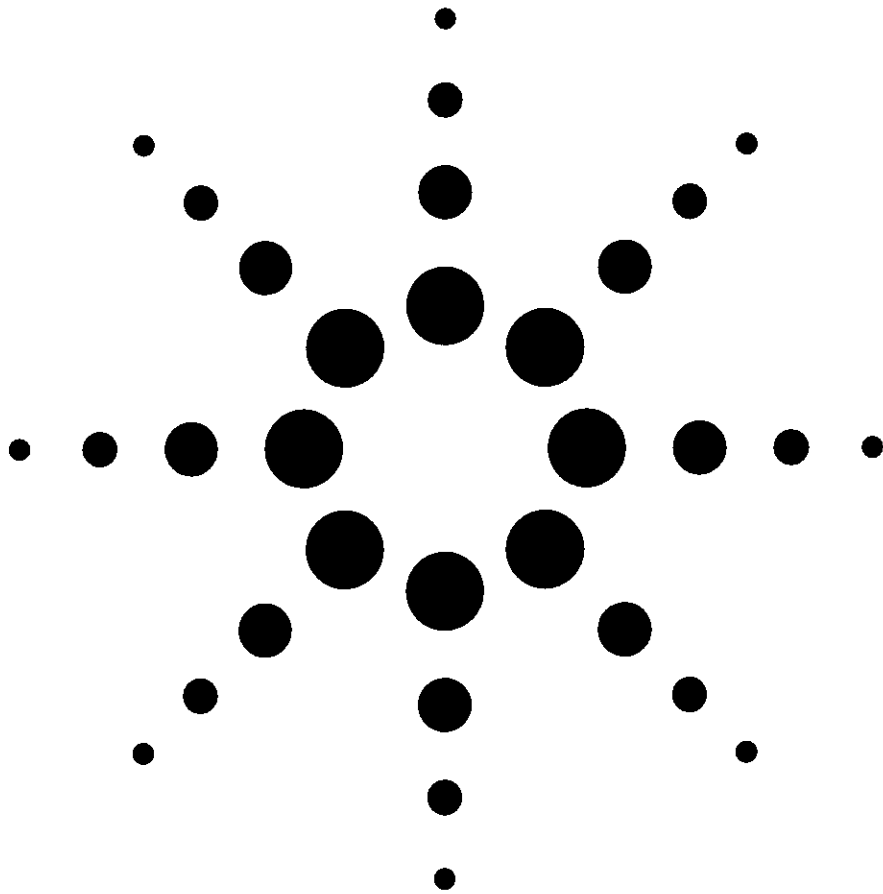

Agilent Technologies

Hewlett-Packard to Agilent Technologies Transition

This documentation supports a product that previously shipped under the Hewlett-Packard company brand name. The brand name has now been changed to Agilent Technologies. The two products are functionally identical, only our name has changed. The document still includes references to Hewlett-Packard products, some of which have been transitioned to Agilent Technologies.

Transition de Hewlett-Packard vers Agilent Technologies

La présente documentation se réfère à un produit qui était auparavant livré sous la marque Hewlett-Packard. Cette marque a été remplacée par Agilent Technologies. D'un point de vue fonctionnel, les deux produits sont identiques et seuls leurs noms les différencient. La documentation comprend toujours des références aux produits Hewlett-Packard, même si certains possèdent déjà l'appellation Agilent Technologies.

Umbenennung Hewlett-Packard in Agilent Technologies

Diese Dokumentation gehört zu einem Produkt, das früher unter dem Markennamen Hewlett-Packard ausgeliefert wurde. Der Markenname lautet in der Zwischenzeit Agilent Technologies. Die Funktionalität der beiden Produkte ist identisch, nur der Name hat sich geändert. Im Dokument wird zum Teil immer noch auf Hewlett-Packard verwiesen. An anderer Stelle wurde die Marke in Agilent Technologies umbenannt.

Hewlett-Packard e la transizione ad Agilent Technologies

La presente documentazione è fornita a supporto di un prodotto che in precedenza veniva commercializzato con il marchio Hewlett-Packard. Tale marchio è stato trasformato in Agilent Technologies. I due prodotti sono identici dal punto di vista funzionale; il cambiamento ha riguardato soltanto il nome della società. Nella documentazione sono ancora presenti riferimenti ai prodotti Hewlett-Packard, alcuni dei quali tuttavia sono passati sotto il marchio Agilent Technologies.

Transición de Hewlett-Packard a Agilent Technologies

Esta documentación proporciona información técnica sobre un producto que anteriormente se distribuía bajo el nombre de marca de la compañía Hewlett-Packard. Dicho nombre de marca ha cambiado ahora a Agilent Technologies. Los dos productos son funcionalmente idénticos, sólo ha cambiado nuestro nombre. Este documento aún incluye referencias a productos de Hewlett-Packard, algunos de los cuales han pasado a Agilent Technologies.

Изменение торговой марки Hewlett-Packard на Agilent Technologies

Эта документация относится к продукту, который ранее поставлялся под торговой маркой Hewlett-Packard. Теперь торговая марка изменена на Agilent Technologies, при этом функциональные возможности продукта не изменились. В документе могут встречаться ссылки на продукты Hewlett-Packard, однако некоторые из них теперь являются продуктами Agilent Technologies.

Hewlett-Packard가 Agilent Technologies로 변경되었습니다.

본 설명서의 내용은 Hewlett-Packard 회사 이름으로 출시된 기존의 제품에도 적용됩니다. 상표명이 Agilent Technologies로 변경되었습니다. 제품명만 변경된 것일뿐 기능적인 면에서는 이전과 동일합니다. 설명서에는 Hewlett-Packard 제품에 적용되는 참조사항이 포함되어 있으며, 일부 제품명은 Agilent Technologies로 변경되어 있습니다.

Hewlett-PackardからAgilent Technologiesへの移行

この文書は、以前にHewlett-Packardの商標名で出荷された製品をサポートするものです。その商標名は現在、Agilent Technologiesに変更されています。2つの商標の製品は機能的に同じですが、当社の商標のみが変更されました。この文書にはHewlett-Packard製品に関する参照事項がまだ含まれていますが、その一部はAgilent Technologiesに移行されています。

关于惠普公司更名为安捷伦科技公司的事宜

此文档支持先前以惠普公司 (Hewlett-Packard) 商标名称交付的产品。此商标名称现已更名为安捷伦科技公司 (Agilent Technologies)。两个商标名称的产品在功能上完全相同，只是更改了名称。文档中仍然会提到惠普产品，但其中一些产品名称已改为安捷伦科技公司。

關於惠普公司更名爲安捷倫科技事宜

本資料支持先前以惠普公司 (Hewlett-Packard) 品牌交付的產品，而該品牌現已改名爲安捷倫科技 (Agilent Technologies)。兩個品牌的產品功能相同，僅名稱更換而已。本資料仍含有惠普公司產品參數，但其中的一些產品名稱已改爲安捷倫科技。

HP 8657A

HP 8657B

Synthesized RF Signal Generators

Operating and Calibration Guide

(including Options 001, 002 and 003)



HP Part No. 08657-91039

Printed in USA

October 1998

© Copyright Hewlett-Packard Ltd. 1998

Notice

The information contained in this document is subject to change without notice.

Hewlett-Packard makes no warranty of any kind with regard to this material, including but not limited to, the implied warranties of merchantability and fitness for a particular purpose. Hewlett-Packard shall not be liable for errors contained herein or for incidental or consequential damages in connection with the furnishing, performance, or use of this material.

This manual applies to instruments with serial numbers prefix:

HP 8657A	3604U
HP 8657B	3630U

© Copyright Hewlett-Packard Ltd. 1998.
All Rights Reserved. Reproduction, adaptation, or translation without prior written permission is prohibited, except as allowed under the copyright laws. Station Road, South Queensferry, Scotland, EH30 9TG, UK.

Warranty

This Hewlett-Packard product is warranted against defects in materials and workmanship for a period of one year from date of shipment. During the warranty period, Hewlett-Packard Company will, at its option, either repair or replace products which prove to be defective.

For warranty service or repair, this product must be returned to a service facility designated by HP. Buyer shall prepay shipping charges to HP and HP shall pay shipping charges to return the product to Buyer. However, Buyer shall pay all shipping charges, duties, and taxes for products returned to HP from another country.

Limitation of Warranty

The foregoing warranty shall not apply to defects resulting from:

- 1 Improper or inadequate maintenance, adjustment, calibration, or operation by Buyer;
- 2 Buyer-supplied software, hardware, interfacing or consumables;
- 3 Unauthorized modification or misuse;
- 4 Operation outside of the environmental and electrical specifications for the product;
- 5 Improper site preparation and maintenance; or
- 6 Customer induced contamination or leaks.

THE WARRANTY SET FORTH IS EXCLUSIVE AND NO OTHER WARRANTY, WHETHER WRITTEN OR ORAL, IS EXPRESSED OR IMPLIED. HP SPECIFICALLY DISCLAIMS THE IMPLIED WARRANTIES OF MERCHANTABILITY AND FITNESS FOR A PARTICULAR PURPOSE.

Limitation of Remedies and Liability

THE REMEDIES PROVIDED HEREIN ARE BUYER'S SOLE AND EXCLUSIVE REMEDIES. IN NO EVENT SHALL HP BE LIABLE FOR DIRECT, INDIRECT, SPECIAL, INCIDENTAL, OR CONSEQUENTIAL DAMAGES (INCLUDING LOSS OF PROFITS) WHETHER BASED ON CONTRACT, TORT OR ANY OTHER LEGAL THEORY.

Declarations of Conformity

Declarations of Conformity

Declaration of Conformity according to ISO/IEC Guide 22 and EN45014		
Manufacturer's Name:	Hewlett-Packard Ltd.	
Manufacturer's Address:	Queensferry Microwave Division South Queensferry West Lothian, EH30 9TG Scotland, United Kingdom	
Declares that the product		
Product Name:	Signal Generator	
Model Number:	HP 8657A	
Product Options:	This declaration covers all options of the above product as detailed in TCF A-5951-9852-02	
Conforms with the protection requirements of European Council Directive 89/336/EEC on the approximation of the laws of the member states relating to electromagnetic compatibility, against EMC test specifications EN 55011:1991 (Group 1, Class A) and EN 50082-1:1992		
As Detailed in:	Electromagnetic Compatibility (EMC) Technical Construction File (TCF) No. A-5951-9852-02	
Assessed by:	DTI Appointed Competent Body EMC Test Centre, GEC-Marconi Avionics Ltd., Maxwell Building, Donibristle Industrial Park, KY11 5LB Scotland, United Kingdom	
Technical Report Number:6893/2200/CBR, dated 23 September 1997		
Supplementary Information:		
The product conforms to the following safety standards:		
EN 61010-1(1993) / IEC 1010-1(1990) +A1(1992) +A2(1995) CSA-C22.2 No. 1010.1-93 EN 60825-1(1994) / IEC 825-1(1993)		
The product herewith complies with the requirements of the Low Voltage Directive 73/23/EEC, and carries the CE marking accordingly.		
<i>South Queensferry, Scotland</i>	<i>09 October 1998</i>	
Location	Date	R.M. Evans / Quality Manager

Europe Contact:

Your local Hewlett-Packard Sales and Service Office or Hewlett-Packard GmbH, Department 2Q/
Standards Europe Herrenberger Strasse 130, D7030 Boblinger (Fax: +49-7031-143143)

Declaration of Conformity		
according to ISO/IEC Guide 22 and EN45014		
Manufacturer's Name:	Hewlett-Packard Ltd.	
Manufacturer's Address:	Queensferry Microwave Division South Queensferry West Lothian, EH30 9TG Scotland, United Kingdom	
Declares that the product		
Product Name:	Synthesized Signal Generator	
Model Number:	HP 8657B	
Product Options:	This declaration covers all options of the above product as detailed in TCF A-5951-9852-02	
Conforms with the protection requirements of European Council Directive 89/336/EEC on the approximation of the laws of the member states relating to electromagnetic compatibility, against EMC test specifications EN 55011:1991 (Group 1, Class A) and EN 50082-1:1992		
As Detailed in:	Electromagnetic Compatibility (EMC) Technical Construction File (TCF) No. A-5951-9852-02	
Assessed by:	DTI Appointed Competent Body EMC Test Centre, GEC-Marconi Avionics Ltd., Maxwell Building, Donibristle Industrial Park, KY11 5LB Scotland, United Kingdom	
Technical Report Number:6893/2200/CBR, dated 23 September 1997		
Supplementary Information:		
The product conforms to the following safety standards:		
EN 61010-1(1993) / IEC 1010-1(1990) +A1(1992) +A2(1995) CSA-C22.2 No. 1010.1-93 EN 60825-1(1994) / IEC 825-1(1993)		
The product herewith complies with the requirements of the Low Voltage Directive 73/23/EEC, and carries the CE marking accordingly.		
<i>South Queensferry, Scotland</i>	<i>09 October 1998</i>	
<i>Location</i>	<i>Date</i>	<i>R.M. Evans / Quality Manager</i>

Europe Contact:

Your local Hewlett-Packard Sales and Service Office or Hewlett-Packard GmbH, Department 2Q/
Standards Europe Herrenberger Strasse 130, D7030 Boblingen (Fax: +49-7031-143143)

Statement of Compliance

Statement of Compliance

Electromagnetic Compatibility (EMC) Information

This product has been designed to meet the protection requirements of the European Communities Electromagnetic Compatibility (EMC) directives:

- EN55011:1991 (Group 1, Class A)
- EN50082-1:1992
- IEC 1000-4-2 (1995) ESD
- IEC 1000-4-3 (1995) Radiated Susceptibility
- IEC 1000-4-4 (1995) EFT

In order to preserve the EMC performance of the product, any cable which becomes worn or damaged must be replaced with the same type and specification.

Safety Information

This instrument has been designed and tested in accordance with publication EN61010-1(1993) / IEC 1010-1(1990) +A1(1992) +A2(1994) / CSA C22.2 No. 1010.1(1993) Safety Requirements for Electrical Equipment for Measurement, Control and Laboratory Use, and has been supplied in a safe condition. The instruction documentation contains information and warnings which must be followed by the user to ensure safe operation and to maintain the instrument in a safe condition.

Noise Declaration

LpA<70dB

am Arbeitsplatz (operator position)

normaler Betrieb (normal position)

nach DIN 45635 pt.19 (per ISO 7779)

General Safety Information

The following general safety precautions must be observed during all phases of operation, service, and repair of this instrument. Failure to comply with these precautions or with specific warnings elsewhere in this manual violates safety standards of design, manufacture, and intended use of the instrument. Hewlett-Packard Company assumes no liability for the customer's failure to comply with these requirements.

WARNING

This is a Safety Class I instrument (provided with a protective earthing ground, incorporated in the powercord). The mains plug shall only be inserted in a socket outlet provided with a protective earth contact. Any interruption of the protective conductor inside or outside of the instrument is likely to make the instrument dangerous. Intentional interruption is prohibited.

DO NOT operate the product in an explosive atmosphere or in the presence of flammable gasses or fumes.

DO NOT use repaired fuses or short-circuited fuseholders: For continued protection against fire, replace the line fuse(s) only with fuse(s) of the same voltage and current rating and type.

DO NOT perform procedures involving cover or shield removal unless you are qualified to do so: Operating personnel must not remove equipment covers or shields. Procedures involving the removal of covers and shields are for use by service-trained personnel only.

DO NOT service or adjust alone: Under certain conditions, dangerous voltages may exist even with the equipment switched off. To avoid dangerous electrical shock, service personnel must not attempt internal service or adjustment unless another person, capable of rendering first aid and resuscitation, is present.











DO NOT operate damaged equipment: Whenever it is possible that the safety protection features built into this product have been impaired, either through physical damage, excessive moisture, or any other reason, REMOVE POWER and do not use the product until safe operation can be verified by service-trained personnel. If necessary, return the product to a Hewlett-Packard Sales and Service Office for service and repair to ensure the safety features are maintained.

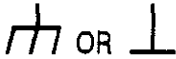

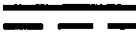
DO NOT substitute parts or modify equipment: Because of the danger of introducing additional hazards, do not install substitute parts or perform any unauthorized modification to the product. Return the product to a Hewlett-Packard Sales and Service Office for service and repair to ensure the safety features are maintained.

General Safety Information

Safety Symbols

The following symbols on the instrument and in the manual indicate precautions which must be taken to maintain safe operation of the instrument.

Safety Symbols	
	The Instruction Documentation Symbol. The product is marked with this symbol when it is necessary for the user to refer to the instructions in the supplied documentation.
	Indicates the field wiring terminal that must be connected to earth ground before operating the equipment - protects against electrical shock in case of fault.
	Frame or chassis ground terminal - typically connects to the equipment's metal frame.
	Alternating current (AC)
	Direct current (DC)
	Indicates hazardous voltages
	Warning denotes a hazard. It calls attention to a procedure, which if not correctly performed or adhered to could result in injury or loss of life. Do not proceed beyond a warning note until the indicated conditions are fully understood and met.
	Caution denotes a hazard. It calls attention to a procedure, which if not correctly performed or adhered to could result in damage to or destruction of the instrument. Do not proceed beyond a caution note until the indicated conditions are fully understood and met.
	The CE mark shows that the product complies with all relevant European Legal Directives.
ISM 1-A	This is a symbol of an Industrial, Scientific, and Medical Group 1 Class A product.
	The CSA mark is a registered trademark of the Canadian Standards Association, and indicates compliance to the standards laid out by them.

	<p>This symbol indicates the position of the operating switch for 'On' mode.</p>
	<p>This symbol indicates the position of the operating switch for 'Stand-by' mode. Note, the instrument is NOT isolated from the mains when the switch is in this position. To isolate the instrument, the mains coupler (mains input cord) should be removed from the power supply.</p>
	<p>The C-Tick mark is a registered trademark of the Spectrum Management Agency of Australia. This signifies compliance with the Australian EMC Framework Regulations under the terms of the Radiocommunications Act of 1992.</p>

Additional Symbols

	<p>The Static Sensitive Devices symbol is used in this manual to identify processes which may expose the components of the instrument to potential damage due to electrostatic discharge.</p>
--	---

General Safety Information

TABLE OF CONTENTS

Section 1-General Information

Introduction	1-1
Information Covered by this Manual	1-1
Specifications	1-1
Safety Considerations	1-2
Instruments Covered by this Manual	1-2
Options	1-2
Electrical Options	1-2
Mechanical Options	1-3
Documentation Options	1-3
Warranty Option	1-3
Accessories Supplied	1-3
Accessories Available	1-3
Recommended Test Equipment	1-4
HP 8656B Instrument Description	1-4
Carrier Frequency	1-4
Output Amplitude	1-4
Modulation Capabilities	1-4
HP 8657A Instrument Description	1-5
Carrier Frequency	1-5
Output Amplitude	1-5
Modulation Capabilities	1-5
HP 8657B Instrument Description	1-6
Carrier Frequency	1-6
Output Amplitude	1-6
Modulation Capabilities	1-6
Hewlett-Packard Interface Bus	1-6

Section 2-Installation

Introduction	2-1
Initial Inspection	2-1
Installation Check list	2-1
Preparation For Use	2-2
Power Requirements	2-2
Line Voltage Selection and Fuse Replacement	2-2
Power Cables	2-4
Operating Enviroment	2-4
Time Base Selection	2-6
Hewlett-Packard Interface Bus (HP-IB)	2-6

HP-IB Address Selection	2-7
HP 8656B/8657A	2-7
HP 8657B	2-8
Connection to the HP-IB	2-8
Coaxial Connectors	2-11
Timebase Looping Cable (Option 001 Only)	2-11
Pulse Modulation Input Impedance (HP 8657B Option 003 or 004 Only)	2-11
Bench Operation	2-11
Rack Mounting	2-12
Internal Battery	2-12
Storage and Shipment	2-13
Environment	2-13
Packaging	2-13

Section 3-Operation

Introduction	3-1
Local Operation	3-1
Remote Operation (HP-IB)	3-1
User Confidence Tests	3-1
Remote Operation, Hewlett-Packard Interface Bus	3-2
HP-IB Compatibility	3-2
Remote Operation	3-2
Local Operation	3-2
Addressing	3-3
Data Messages	3-4
Receiving the Data Message	3-4
Sending the Data Message	3-6
Receiving the Trigger Message	3-6
Receiving the Clear Message	3-6
Receiving the Remote Message	3-7
Receiving the Local Message	3-7
Receiving the Local Lockout Message	3-7
Receiving the Clear Lockout/Set Local Message	3-7
Receiving the Pass Control Message	3-8
Sending the Require Service Message	3-8
Sending the Status Bit Message	3-8
Receiving the Abort Message	3-8
Switching Characteristics	3-13
Selecting the Correct Pulse Modulation Mode	3-15
Impedance Mismatching	3-15
Summary	3-16
Detailed Operating Instructions	3-17
Amplitude	3-18
Amplitude Conversion	3-20
Amplitude Offset	3-22
Amplitude Up/Down	3-23
Display Amplitude Offset	3-25
Display	3-26
Display Sequence	3-27

Frequency	3-28
Frequency, Coarse and Fine Tune	3-30
Frequency, Phase Up/Down	3-32
Frequency, Up/Down	3-33
HP-IB Address Display	3-36
Increment Value Change	3-37
Increment Value Display	3-39
Instrument Preset	3-41
Modulation, AM	3-42
Modulation, AM Up/Down	3-44
Modulation, DC FM	3-46
Modulation, DC FM Up/Down	3-48
Modulation, External Source	3-50
Modulation, FM	3-51
Modulation, FM Up/Down	3-53
Modulation, Mixed	3-55
Modulation, Off	3-60
Modulation, Pulse	3-62
Modulation, Pulse (Fast Mode)	3-64
Recall	3-66
RF On/Off	3-67
Save	3-68
Sequence	3-69
User Confidence Tests	3-71
Basic Functional Checks	3-71
Frequency Check	3-72
Output Level Checks	3-73
FM Check	3-74
DC FM Check	3-75
AM Check	3-75
HP-IB Functional Checks	3-75
Address Recognition	3-76
Remote and Local Messages and the Local Key	3-77
Data Message	3-77
Local Lockout and Clear Lockout/Set Local Messages	3-78
Clear Message	3-78
Abort Message	3-79

Section4-Performance Tests

Introduction	4-1
Equipment Required	4-1
Performance Test Record	4-1
Calibration Cycle	4-1
Abbreviated Performance Testing	4-1
Test Procedures	4-2
Performance Test 1-Spectral Purity	4-4
HP 8656B Specifications	4-4
HP 8657A Specifications	4-5
HP 8657B Specifications	4-6

Performance Test 1-HP8656B SSB Phase Noise (1 Hz Bandwidth)	4-14
Performance Test 1-HP8657A/57B SSB Phase Noise (1 Hz Bandwidth)	4-16
Performance Test 2-Output Level Accuracy and Flatness Tests	4-21
HP 8656B Specifications	4-21
HP 8657A Specifications	4-21
HP 8657B Specifications	4-22
Performance Test 3-Modulation Tests	4-26
HP 8656B Specifications	4-26
HP 8657A Specifications	4-28
HP 8657B Specifications	4-30
Performance Test 3-AC Modulation	4-32
Performance Test 3-DC Modulation	4-40
Performance Test 3-Pulse Modulation (HP 8657B Only)	4-42
Performance Test 4-Output Leakage Tests	4-48
Performance Test 5-SWR Test (HP 8656B and HP 8657A Only)	4-50
Performance Test Record-Spectral Purity Tests	4-54
Performance Test Record-Output Level Accuracy and Flatness Tests	4-56
Performance Test Record-AC Modulation Tests	4-58
Performance Test Record-DC Modulation Tests	4-61
Performance Test Record-Output Leakage Tests	4-62
Performance Test Record-SWR Tests	4-63

Section 5-Adjustments

Introduction	5-1
Safety Considerations	5-1
Equipment Required	5-1
Factory-Selected Components	5-1
Post-Repair Adjustments	5-1
Related Adjustments	5-1
Adjustment 1a-HP 8656B Power Supply Voltage Adjustments	5-4
Adjustment 1b-HP 8657A Power Supply Voltage Adjustments	5-5
Adjustment 1c-HP 8657B Power Supply Voltage Adjustments	5-6
Adjustment 2-Reference Voltage Adjustment	5-8
Adjustment 3-Audio Oscillator Level Adjustment	5-9
Adjustment 4-AM Offset Adjustment	5-11
Adjustment 5-50 MHz Reference Oscillator Level Adjustment	5-13
Adjustment 6-50 MHz Reference Oscillator Frequency Adjustment	5-14
Adjustment 7-122 MHz Harmonic Adjustments	5-15
Adjustment 8-400 MHz Bandpass Filter Adjustment	5-16
Adjustment 9-690 to 740 MHz IF Compensation Adjustment and Attenuator Pad Select	5-17
Adjustment 10a-High Frequency Loop Adjustment (HP 8656B Only)	5-19
Adjustment 10b-715 MHz Sideband Adjustment (HP 8656B Only)	5-21
Adjustment 10c-Notch Filter Adjustments (HP 8656B Only)	5-23
Adjustment 10d-HP 8657A and HP 8657B Notch Filter Adjustments	5-25
Adjustment 11-400 MHz Notch Filter Adjustment (HP 8657A and HP 8657B Only)	5-29
Adjustment 12a-HP 8656B Level and ALC Loop Detector Adjustment	5-30
Adjustment 12b-HP 8656B Heterodyne Band 800 MHz Bandpass Filter Adjustment	5-32
Adjustment 12c-HP 8656B Heterodyne Band Accuracy and Flatness Adjustments	5-34
Adjustment 12d-HP 8657A/HP 8657B Level and ALC Loop Detector Adjustments	5-36
Adjustment 13-AM% and ALC Loop AM Adjustments	5-38
Adjustment 14-HP 8657B Only - AM% in the Double Band Adjustments	5-40

Adjustment 15-FM Calibration Pretune Adjustment	5-42
Adjustment 16-API 1,2,3, and 4 Adjustments	5-44
Adjustment 17-Pedestal Adjustment	5-46
Adjustment 18-Integrator Input Offset Adjustment	5-47
Adjustment 19-DC FM Spurious Signal Adjustment	5-48
Adjustment 20-Voltage Offset Adjustment.	5-50
Adjustment 21-DC FM Offset Adjustment	5-52
Adjustment 22-FM In Band Gain Adjustment	5-54
Adjustment 23-FM Deviation Adjustment.	5-56
Adjustment 23-Option 001 MHz Reference Oscillator Frequency	5-58

Section 1

GENERAL INFORMATION

1-1. INTRODUCTION

This manual contains information required to install, operate, test, and adjust the Hewlett-Packard Model 8656B/8657A/8657B Signal Generators. Unless otherwise stated the information applies to all three Signal Generators.

Information required to troubleshoot and repair the Signal Generators is contained in the relevant Service Manual:

- HP part number 08656-90197 for the HP 8656B.
- HP part number 08657-90004 for the HP 8657A.
- HP part number 08657-90007 for the HP 8657B.

Listed on the title page of this manual, below the manual part number, is a "Microfiche" part number. This number may be used to order 100 × 150 millimeter (4- × 6-inch) microfilm transparencies of this manual. Each microfiche contains up to 96 photo-duplicates of the manual's pages. The microfiche package also includes the latest MANUAL UPDATES supplement, as well as all pertinent Service Notes.

1-2. INFORMATION COVERED BY THIS MANUAL

This manual consists of five sections as listed below:

Section 1 General Information, describes the instruments documented by this manual, it covers instrument description, options, accessories, specifications, and other basic information.

Section 2 Installation, provides information about initial inspection, preparation for use (including time base selection, and HP-IB address selection for remote operation), and storage and shipment.

Section 3 Operation, provides information for local and remote operation. This section also includes User Confidence Tests.

Section 4 Performance Tests, describes the procedures required to check the performance of the instrument against the specifications listed in Tables 1-1 through 1-3.

Section 5 Adjustments, describes the adjustment procedures required to enable the instrument to meet the specifications listed in Tables 1-1 through 1-3.

1-3. SPECIFICATIONS

Instrument specifications are listed in Tables 1-1 through 1-3. These specifications are the performance standards or limits against which the instrument may be tested. Supplemental characteristics are also listed in Tables 1-1 through 1-3. Supplemental characteristics are not warranted specifications, but are typical characteristics included as additional information for the user.

1-4. SAFETY CONSIDERATIONS

This product is a Safety Class 1 instrument, that is, one provided with a protective earth terminal. The instrument and all related documentation must be reviewed for familiarization with safety markings and instructions before operation. Refer to the Safety Considerations page found at the beginning of this manual for a summary of the safety information.

1-5. INSTRUMENTS COVERED BY THIS MANUAL

This instrument has a two-part serial number, in the form 0000U00000 OR 0000A00000. This is stamped on the serial number plate attached to the rear panel of the instrument. The first four digits and the letter constitute the serial number prefix, and the last five digits form the suffix. The prefix is the same for all identical instruments. It changes only when a change is made to the instrument. The suffix is different for each instrument. The contents of this manual apply directly to instruments having the same serial number prefix(es) as listed under SERIAL NUMBERS on the title page.

Manual Updates. An instrument manufactured after the printing of this manual may have a serial prefix that is not listed on the title page. An unlisted serial prefix number indicates that the instrument differs in some way from those documented in this manual.

A "MANUAL UPDATES" packet is shipped with the manual, when necessary, to provide you with the most current information available at the time of shipment. These packets consist of replacement and addition pages which should be incorporated into the manual to bring it up to date.

Hewlett-Packard offers a **Documentation Update Service** that will provide you with further updates as they become available. If you operate or service instruments of different serial prefixes, we strongly recommend that you join this service immediately to ensure that your manual is kept current. For more information refer to the **Documentation Update Service** reply card included with this manual.

1-6. OPTIONS

The following options are available and may have been ordered and received with your Signal Generator.

Electrical Options

High Stability Timebase Option 001. A 10 MHz crystal reference for increased frequency accuracy and stability is installed. You can add Option 001 after you have received your instrument by ordering:

- HP part number 08656-60195 for the HP 8656B/8657A.
- HP part number 08657-61054 for the HP 8657B.

Pulse Modulation Option 003. Adds Pulse Modulation to the HP 8657B. Option 003 fitted to a Standard or Option 001 HP 8657B, provides the Pulse Modulation input connector on the front panel. Option 003 fitted to an Option 002 HP 8657B, provides the connector on the rear panel along with the RF Output and AM/FM Modulation Input/Output connectors. For information about factory retrofitting Option 003 after you have received your HP 8657B, contact your nearest Hewlett-Packard sales office.

Mechanical Options

To add any of the mechanical options after you have received your Signal Generator, order the appropriate HP part number listed with each option.

Rear-Panel Inputs and Outputs Option 002. RF Output and AM/FM Modulation Input/Output connectors are located on the rear-panel. Order:

- HP part number 08656-60197 for the HP 8656B
- HP part number 08657-61037 for the HP 8657A.
- HP part number 08657-61055 for the HP 8657B.

Front Handle Kit Option 907. Ease of handling is increased with the front-panel handles. Order HP part number 5062-3989.

Rack Flange Kit Option 908. This kit contains all necessary hardware and installation instructions for mounting the instrument in a rack with 482.5 millimeter (standard 19-inch) spacing. Order HP part number 5062-3977.

Rack Flange and Front Handle Combination Kit Option 909. This kit is not simply a front handle kit and rack flange kit packaged together. The combination is made up of unique parts which include both functions. Order HP part number 5062-3983.

Documentation Options

Extra Manual Set Option 910. Provides an additional copy of the Operation and Calibration Manual and two copies of the Service Manual.

Add Service Manual Option 915. Provides a copy of the Service Manual. The Service Manual contains information to enable qualified service personnel to troubleshoot and repair the Signal Generator.

Warranty Option

Three-Year Extended Hardware Support Option W30. Provides 2 additional years of return-to-HP hardware service support (for 2nd and 3rd years).

1-7. ACCESSORIES SUPPLIED

The accessories supplied with the instrument are:

- An appropriate power cord, see table 2-3 in Section 2.
- An Operating and Calibration Manual.
- A coaxial looping cable (Option 001 only).

1-8. ACCESSORIES AVAILABLE

The following accessories are available for use with the instrument:

- 50 Ω to 75 Ω Adapter, HP model number 11687A (Frequency to 1.3 GHz only).
- HP 8656B/8657A Transit Case, HP part number 9211-2655.
- HP 8657B Transit Case, HP part number 9211-2661.
- Slide Rack Mount Kits - see paragraph 2-17 for further information.

1-9. RECOMMENDED TEST EQUIPMENT

Table 1-4 lists the test equipment required for testing, adjusting, and servicing the Signal Generator. The Critical Specifications column describes the essential requirements for each piece of test equipment. Other equipment can be substituted if it meets or exceeds these critical specifications.

Table 1-6 lists alternate test equipment that can be used. Alternate models may be suggested for additional features that would make them a better choice in some applications. For example, some reasons for recommending an alternate model might be:

- HP-IB programmability,
- Multi-function capability (that is, one model can replace two or more single purpose models).

1-10. HP 8656B INSTRUMENT DESCRIPTION

The Hewlett-Packard Model 8656B is a synthesized signal generator with a carrier frequency range of 100 kHz to 990 MHz. Its output amplitude is leveled and calibrated from +13 to -127 dBm. AM and/or FM functions can be individually selected. The carrier frequency, output amplitude, and modulation functions can be remotely programmed via the Hewlett-Packard Interface Bus. The unique modular design and incorporated service features permit rapid and easy calibration and service.

Carrier Frequency

The Signal Generator covers a carrier frequency range of 100 kHz to 990 MHz (10 kHz to 990 MHz with underrange). Frequency resolution is 10 Hz. An 8-digit LED display of the carrier frequency in MHz is provided. Pushbutton keys permit coarse tuning, fine tuning, and incrementing of the carrier frequency.

Frequency accuracy and stability are dependent on the reference source being used, either the internal 50 MHz reference oscillator or an external source that operates at 1, 5, or 10 MHz. An optional 10 MHz crystal reference is available for increased accuracy and stability (Option 001).

Output Amplitude

The Signal Generator has precise power levels from +13 to -127 dBm (+1.00V to +0.100 V) with overrange at decreased accuracy. The output amplitude from +13 to -127 dBm is accurate to less than or equal to ± 1.0 dB from 100 kHz to 990 MHz. Level flatness is less than or equal to ± 0.1 dB. Output amplitude resolution is 0.1 dB. A $3\frac{1}{2}$ -digit LED display of output amplitude is provided with 7 LED annunciators used to display unit information. Easy conversion of units between dBm, +V, EMF, and so forth is possible.

Modulation Capabilities

The Signal Generator features a versatile internal and external modulation capability for AM and FM. This includes internal 400 Hz or 1 kHz tones; mixed modulation, such as AM/FM, AM/AM, or FM/FM; and the capability to accept low frequency digital unsquelching signals. A 2-digit display of AM depth or FM peak deviation is provided with 11 LED annunciators used to display internal or external modulation source information. Simple keyboard entries of AM depth up to 99% with a resolution of 1%, and FM peak deviation up to 99 kHz with resolutions of 100 Hz (for deviations less than 10 kHz) or 1 kHz (for deviations greater than or equal to 10 kHz) are possible.

1-11. HP 8657A INSTRUMENT DESCRIPTION

The Hewlett-Packard Model 8657A is a synthesized signal generator with a carrier frequency range of 100 kHz to 1040 MHz. Its output amplitude is leveled and calibrated from +13 to -127 dBm. AM and/or FM functions can be individually selected. The carrier frequency, output amplitude, and modulation functions can be remotely programmed via the Hewlett-Packard Interface Bus. The unique modular design and incorporated service features permit rapid and easy calibration and service.

Carrier Frequency

The Signal Generator covers a carrier frequency range of 100 kHz to 1040 MHz (10 kHz to 1040 MHz with underrange). Frequency resolution is 10 Hz. An 8-digit LED display of the carrier frequency in MHz is provided. Pushbutton keys permit coarse tuning, fine tuning, and incrementing of the carrier frequency.

Frequency accuracy and stability are dependent on the reference source being used, either the internal 50 MHz reference oscillator or an external source that operates at 1, 5, or 10 MHz. An optional 10 MHz crystal reference is available for increased accuracy and stability (Option 001).

Output Amplitude

The Signal Generator has precise power levels from +13 to -143.5 dBm (+1.00V to +0.015 nV) with overrange at decreased accuracy. The output amplitude from +7 to -127 dBm is accurate to less than or equal to ± 1.0 dB from 100 kHz to 1040 MHz. Level flatness is less than or equal to ± 0.5 dB with an output amplitude setting of 0.0 dBm. Output amplitude resolution is 0.1 dB. A 3 $\frac{1}{2}$ -digit LED display of output amplitude is provided with 7 LED annunciators used to display unit information. Easy conversion of units between dBm, +V, EMF, and so forth is possible.

Modulation Capabilities

The Signal Generator features a versatile internal and external modulation capability for AM and FM. This includes internal 400 Hz or 1 kHz tones; mixed modulation, such as AM/FM, AM/AM, or FM/FM; and the capability to accept low frequency digital unsquelching signals. A 2-digit display of AM depth or FM peak deviation is provided with 11 LED annunciators used to display internal or external modulation source information. Simple keyboard entries of AM depth up to 99% with a resolution of 1%, and FM peak deviation up to 99 kHz with resolutions of 100 Hz (for deviations less than 10 kHz) or 1 kHz (for deviations greater than or equal to 10 kHz) are possible.

1-12. HP 8657B INSTRUMENT DESCRIPTION

The Hewlett-Packard Model 8657B is a synthesized signal generator with a carrier frequency range of 100 kHz to 2060 MHz. Its output amplitude is leveled and calibrated from +13 to -143.5 dBm. AM and/or FM functions can be individually selected. The carrier frequency, output amplitude, and modulation functions can be remotely programmed via the Hewlett-Packard Interface Bus. The unique modular design and incorporated service features permit rapid and easy calibration and service.

Carrier Frequency

The HP 8657B covers a carrier frequency range of 100 kHz to 2060 MHz (10 kHz with uncalibrated output and modulation). Frequency resolution is 1 Hz. A 10-digit LED display of the carrier frequency in MHz is provided. Pushbutton keys permit coarse tuning, fine tuning, and incrementing of the carrier frequency.

Frequency accuracy and stability are dependent on the reference source being used, either the internal 50 MHz reference oscillator or an external source that operates at 1, 5, or 10 MHz. With Option 001, a 10 MHz crystal reference is available for increased accuracy and stability.

Output Amplitude

The HP 8657B has precise power levels from +7 to -143.5 dBm (114 dB μ V to 36.5 dB μ V) with overrange to +17 dBm at decreased accuracy. The output amplitude from +3.5 to -127 dBm is accurate to less than ± 0.5 dB from 100 kHz to 2060 MHz. Level flatness is less than ± 1.0 dB with an output amplitude setting of 0.0 dBm. Output amplitude resolution is 0.1 dB. A 3^{1/2}-digit LED display of output amplitude is provided with 7 LED annunciators used to display unit information.

Modulation Capabilities

The HP 8657B features a versatile internal and external modulation capability for AM and FM. This includes internal 400 Hz or 1 kHz tones; mixed modulation, such as AM/FM, AM/AM, or FM/FM; and the capability to accept low frequency digital unquenching signals. A 3-digit display of AM depth or FM peak deviation is provided with 12 LED annunciators used to display internal or external modulation source information. Keyboard entries of AM depth up to 100% with a resolution of 1%, and FM peak deviation up to 400 kHz. The resolution of the FM peak deviation depends on the frequency of the carrier signal.

Option 003 adds the capability to generate Pulse Modulation using an external signal source.

1-13. HEWLETT-PACKARD INTERFACE BUS

The Signal Generator has an HP-IB interface and can be used with any HP-IB computing controller or computer for automatic system applications. The Signal Generator is fully programmable via the HP-IB. The Signal Generator's complete compatibility with HP-IB is defined by the following list of interface functions: SH0, E1, AH1, T0, L2, SR0, RL1, PP0, DC1, DT0, and C0. The Signal Generator interfaces with the bus via open collector TTL circuitry. An explanation of the compatibility codes can be found in the IEEE Standard 488 and the identical ANSI Standard MC1.1.

Table 1-1. HP 8656B Specifications (1 of 3)

SPECIFICATIONS describe the instruments warranted performance and apply after a 30 minute warm-up. All SPECIFICATIONS are valid over the signal generator's entire Operating/Environmental Range unless otherwise noted.

SUPPLEMENTAL CHARACTERISTICS (shown in italics) are intended to provide additional information useful in applying the instrument by giving typical (expected), but not warranted performance.

FREQUENCY

Range (8-digit LED display): 100 kHz to 990 MHz.
Resolution: 10 Hz.
Switching Speed (to be within 100 Hz of carrier frequency): <35 ms. (25ms typical at 25°C)
Accuracy and Stability: Same as time base used.

SUPPLEMENTAL CHARACTERISTICS

Frequency Underrange: 10 kHz with uncalibrated output.
Phase Offset: Output phase is adjustable via HP-IB, or from the front panel in 1 degree increments.
Accuracy and Stability: same as internal time base.

Timebase Characteristics:

	Standard	Option 001
Aging Rate	±2 ppm/year	1.5x 10 ⁻⁹ /day (after 10 days warm-up) 1.0 x 10 ⁻⁹ parts/day (after 180 days warm-up)
Temperature (0-55°C)	±10 ppm	7 x 10 ⁻⁹
Line Voltage	—	2 x 10 ⁻⁹ (+5%, -10%)
Frequency	50 MHz	10 MHz
Timebase Reference Signal (Rear Panel)	Available at a level of >0.15 V _{rms} into 50 Ω (Output of 10, 5, or 1 MHz is selectable via internal jumper). If the Option 001 or another external reference is used, only that reference frequency is available as an output.	
External Reference Input (Rear Panel)	Accepts any 10, 5, or 1 MHz (±0.002%) frequency standard at a level >0.15 V _{rms} into 50 Ω.	

SPECTRAL PURITY

Spurious Signals:

Harmonic: <- 30 dBc (≤±7 dBm output levels)
Sub-harmonic: None.
Non-Harmonic: < - 60 dBc (> 5 kHz from carrier in CW mode)

Residual FM (in CW mode):

Frequency Range	Post Detection BW (rms detector)	
	300 Hz to 3 kHz	50 Hz to 15 kHz
0.1 - 123.5 MHz	< 7 Hz	< 15 Hz
123.5 - 247 MHz	< 2 Hz	< 4 Hz
247 - 494 MHz	< 4 Hz	< 8 Hz
494 - 990 MHz	< 7 Hz	< 15 Hz

Residual AM (50 Hz to 15 kHz post-detection noise bandwidth, in CW mode): < - 75 dBc (0.1 to 990 MHz)

SSB Phase Noise (in CW Mode):

Carrier Frequency	SSB ϕ-Noise 20 kHz offset
0.1 to 123.5 MHz	<- 114 dBc/Hz
123.5 to 247 MHz	<- 126 dBc/Hz
247 to 494 MHz	<- 120 dBc/Hz
494 to 990 MHz	<- 114 dBc/Hz

SUPPLEMENTAL CHARACTERISTICS

Typical SSB Phase Noise at 500 MHz

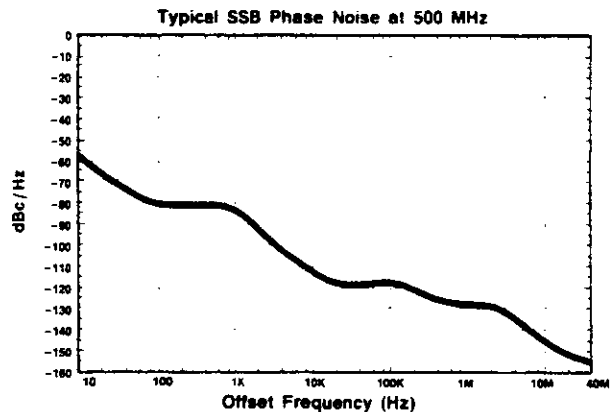

Table 1-1. HP 8656B Specifications (2 of 3)

OUTPUT

Level Range: +13 dBm to -127 dBm into 50Ω.
Resolution: 0.1 dB.
Absolute Level Accuracy¹:
 < ±1.0 dB (123.5 to 990 MHz, +7 to -124 dBm),
 < ±1.5 dB (0.1 to 123.5 MHz, and < -124 dBm
 or < +7 dBm at 0.1 to 990 MHz).
Level Flatness (100 kHz to 990 MHz): ≤ ± 1.0 dB,
 output level setting of 0 dBm.
SWR: <2.0 for levels > -5 dBm.
 <1.5 for levels ≤ -5 dBm.
Reverse-Power Protection: Protects the signal generator
 from applications of up to 25 watts of RF power (from a 50Ω
 source) to 990 MHz into generator output; DC voltage
 cannot exceed 25 V.

SUPPLEMENTAL CHARACTERISTICS

Impedance: 50 Ω Nominal.

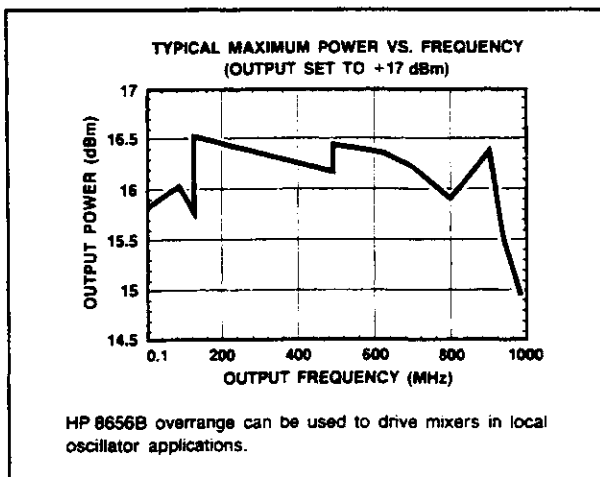

Typical maximum power output versus frequency (output set to +17 dBm)

AMPLITUDE MODULATION

Depth²:
 0 to 99%, output levels of < +7 dBm, frequencies
 from 0.1 to 990 MHz.
 0 to 30%, output levels to +10 dBm, frequencies
 from 0.1 to 990 MHz.
Resolution: 1%.
AM Rate,
Internal: 400 Hz and 1 kHz, ± 3%.
External: 20 Hz to 40 kHz (1 dB bandwidth,
 AC coupled)
AM Distortion (internal rates):
 0 to 30 % AM < 1.5%.
 31 to 70 % AM < 3.0%.
 71 to 90 % AM < 4.0% .

Indicator Accuracy (for depths < 90%, and internal rates
 and levels < +7 dBm)²: < ±2% (±4% of setting).
Incidental Phase Modulation (at 30% AM depth, internal
 rates): < 0.3 radians peak.

FREQUENCY MODULATION

Maximum FM Peak Deviation (Δf_{pk})³:

Center Frequency	Maximum Peak Deviation	
	AC Mode (the lesser of)	DC Mode
0.1 to 123.5 MHz	99 kHz or 4000 x rate (Hz)	99 kHz
123.5 to 247 MHz	50 kHz or 1000 x rate (Hz)	50 kHz
247 to 494 MHz	99 kHz or 2000 x rate (Hz)	99 kHz
494 to 990 MHz	99 kHz or 4000 x rate (Hz)	99 kHz

FM not specified for $f_c - (\Delta f_{pk}) < 100$ kHz

Resolution: 100 Hz for deviations less than 10 kHz; 1 kHz
 for deviations ≥ 10 kHz.

FM Rate

Internal: 400 Hz and 1 kHz, ±3%.

External:

dc to 50 kHz, ac coupled, ±1 dB, 20 Hz to 50 kHz
 dc to 100 kHz, ±3 dB

Center Frequency Accuracy in dc Mode:

Carrier Frequency	Center Frequency Accuracy
0.1 to 123.5 MHz	± 500 Hz
123.5 to 247 MHz	± 125 Hz
247 to 494 MHz	± 250 Hz
494 to 990 MHz	± 500 Hz

Stability: <10 Hz per hour drift.

Indicator Accuracy (internal rates)³: < ±5% of setting.

Incidental AM (peak deviations <20 kHz, internal rates):

- <0.1% (> f_c 500 kHz)
- < 1% (f_c 200 to 500 kHz)
- < 5% (f_c < 200 kHz)

SUPPLEMENTAL CHARACTERISTICS

External Sensitivity: 1 volt peak for indicated accuracy for
 ac signals or 1 volt dc when in dc-FM mode.

External Modulation Input: Front panel BNC, 600 Ω
 dc-coupled; front panel annunciators indicate application of
 1 V peak signal ± 5%.

Modulating Signal Output: Internal modulating signal is
 provided at the front panel BNC connector at nominally
 1 volt peak into a 600 Ω resistive load.

Simultaneous Modulation:

Internal/External: AM/FM, FM/AM, AM/AM, FM/FM,
 External/External: AM/FM.

Table 1-1. HP 8656B Specifications (3 of 3)

REMOTE PROGRAMMING

Interface: HP-IB (Hewlett-Packard's implementation of IEEE Standard 488 (and the identical ANSI Standard MC1.1)).

Interface Functions Implemented: SH0, AH1, T0, L2, SR0, RL1, PP0, DC1, DT0, C0, E1.

Functions Controlled: All functions controlled from the front panel with the exception of DISPLAY, DISPLAY in conjunction with SEQ, display Amplitude Offset, Backspace, COARSE TUNE, FINE TUNE, and display HP-IB ADRS are programmable with the same accuracy and resolution as in local operation.

GENERAL

Operating Temperature Range: 0 to +55°C.

Storage Temperature Range: -40 to +70°C.

Leakage: Conducted and radiated interference is within the requirements of RE02 of MIL STD 461B and FTZ 1115. Furthermore, RF leakage of less than 1.0 μ V is induced in a two-turn loop, 2.5 cm in diameter, held 2.5 cm away from the front surface.

Save/Recall/Sequence Storage Registers:

100 non-volatile registers are available to save front panel settings.

Power Requirements: 100 or 120 or 220 or 240 volts (+5%, -10%) from 48 to 440 Hz; 125 VA maximum.

Weight: Net 18.1 kg (40 lb); shipping 23.6 kg (52 lb).

Dimensions: 133H x 425W x 574D mm
(5.25 x 16.75 x 22.6 inches.)

HP System II module size: 5 1/4H x 1MW x 17 D.

¹ Absolute level accuracy includes allowances for detector linearity, temperature, flatness, attenuator accuracy and measurement uncertainty.

² AM depth is further limited by Indicator Accuracy specification.

³ FM depth is further limited by Indicator Accuracy specifications.

⁴ FM distortion only applies at deviations up to 25 kHz for 123.5 < f_c < 247 MHz, and 50 kHz for 247 < f_c < 494 MHz. Typical total FM distortion (harmonic and non-harmonic) is less than 1.5% for all specified deviations and external rates from dc to 100 kHz.

⁵ Typically < 0.5% THD for peak deviations > 1 kHz and at normal rates.

Table 1-2. HP 8657A Specifications (1 of 3)

SPECIFICATIONS describe the instruments warranted performance and apply after a 30 minute warm-up. All SPECIFICATIONS are valid over the signal generator's entire Operating/Environmental Range unless otherwise noted.

SUPPLEMENTAL CHARACTERISTICS (shown in italics) are intended to provide additional information useful in applying the instrument by giving typical (expected), but not warranted performance.

FREQUENCY

Range (8-digit LED display): 100 kHz to 1040 MHz.

Resolution: 10 Hz.

Display Resolution:

10 Hz for frequencies < 1000 MHz

100 Hz for frequencies ≥ 1000 MHz

Switching Speed (to be within 100 Hz of carrier frequency): <35 ms. (30 ms typical at 25°C)

Accuracy and Stability: Same as time base used.

SUPPLEMENTAL CHARACTERISTICS

Frequency Underrange: To 10 kHz with uncalibrated output and modulation.

Phase Offset: Output signal phase is adjustable in 1 degree nominal increments.

Timebase Characteristics:

	Standard	Option 001
Aging Rate	±2 ppm/year	1.0 x 10 ⁻⁹ /day ± 1.5 x 10 ⁻⁸ parts/day (after 10 days warm-up) ± 1.0 x 10 ⁻⁹ parts/day (after 180 days warm-up)
Temperature (0-55°C)	±10 ppm	7 x 10 ⁻⁹
Line Voltage	—	2 x 10 ⁻⁹ (+5%, -10%)
Frequency	50 MHz	10 MHz
Timebase Reference Signal (Rear Panel)	Available at a level of >0.15 V _{rms} into 50 Ω (Output of 10, 5, or 1 MHz is selectable via internal jumper). If external reference is used, output will be the same frequency.	
External Reference Input (Rear Panel)	Accepts any 10, 5, or 1 MHz (±0.002%) input (Rear Panel) frequency standard at a level >0.15 V _{rms} into 50 Ω.	

SPECTRAL PURITY

Spurious Signals (≤+7 dBm output levels):

Harmonic: <- 30 dBc.

Sub-harmonic: None.

Non-Harmonic (CW mode):

Frequency Range	Offset from Carrier	
	5 kHz to 2 MHz	> 2 MHz
0.1 - 130 MHz	- 60 dBc	<- 60 dBc
130 - 260 MHz	- 72 dBc	<- 60 dBc
260 - 520 MHz	- 66 dBc	<- 60 dBc
520 - 1040 MHz	- 60 dBc	<- 60 dBc

Residual FM (in CW mode):

Frequency Range	Post Detection BW (rms detector)	
	300 Hz to 3 kHz	50 Hz to 15 kHz
0.1 - 130 MHz	4 Hz	6 Hz
130 - 260 MHz	1 Hz	1.5 Hz
260 - 520 MHz	2 Hz	3 Hz
520 - 1040 MHz	4 Hz	6 Hz

Residual AM (50 Hz to 15 kHz post-detection noise bandwidth, in CW mode): <0.04% AM.

SSB Phase Noise (in CW Mode):

Carrier Frequency	SSB φ-Noise 20 kHz offset
0.1 to 130 MHz	<- 124 dBc/Hz
130 to 260 MHz	<- 136 dBc/Hz
260 to 520 MHz	<- 130 dBc/Hz
520 to 1040 MHz	<- 124 dBc/Hz

SUPPLEMENTAL CHARACTERISTICS

Typical SSB Phase Noise at 500 MHz

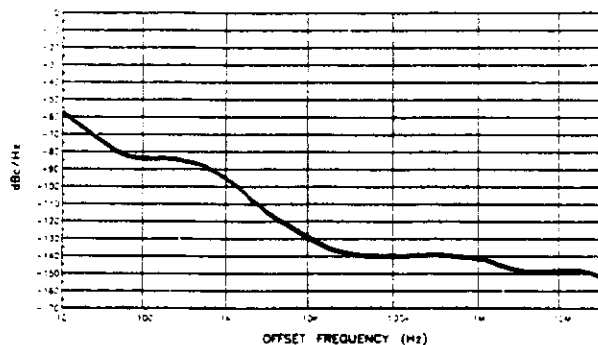

Table 1-2. HP 8657A Specifications (2 of 3)

OUTPUT

Level Range (3 1/2-digit LED display): +13 dBm to -143.5 dBm into 50Ω, +10 dBm to -143.5 dBm for frequencies from 100 kHz to 1 MHz.

Resolution: 0.1 dB.

Absolute Level Accuracy ¹:

< ±1.0 dB (+7 to -127 dBm),

< ±1.5 dB (>+7 dBm).

Level Flatness (100 kHz to 1040 MHz): ±0.5 dB, output level setting of 0 dBm.

SWR ($f_c \geq 400$ kHz): <1.5 for levels <- 3.5 dBm.
<2.0 for levels ≤ +13 dBm.

Reverse-Power Protection: Protects the signal generator from applications of up to 50 watts of RF power (from a 50Ω source) to 1040 MHz into generator output; DC voltage cannot exceed 50 V.

SUPPLEMENTAL CHARACTERISTICS

Impedance: 50 Ω Nominal.

Output Level Overrange: To +17 dBm

Absolute level Accuracy:

< ±1.5 dB, output levels <- 127 dBm.

< ± 0.5 dB, 25°C ±10°C, +7 to -127 dBm.

TYPICAL MAXIMUM POWER VS. FREQUENCY
(OUTPUT SET TP +17 dBm)

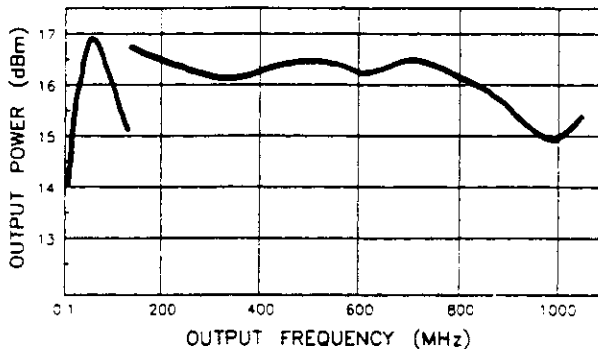

AMPLITUDE MODULATION

AM Depth (2-digit LED display)²:

0 to 99%, level ≤ +7 dBm, $f_c \geq 400$ kHz ³.

0 to 30%, level ≤ +10 dBm, $f_c \geq 400$ kHz ³.

Resolution: 1%.

AM Rate,

Internal: 400 Hz and 1 kHz, ± 2%.

External: 20 Hz to 40 kHz (1 dB bandwidth, AC coupled)

AM Distortion (internal rates, level < +7 dBm):

0 to 30 % AM < 1.5% THD plus noise.

31 to 70 % AM < 3.0% THD plus noise.

71 to 90 % AM < 4.0% THD plus noise.

Indicator Accuracy (for depths < 90%, and internal rates and levels < +7 dBm): < ±(2% +6% of setting).

Incidental Phase Modulation (at 30% AM depth, internal rates): < 0.3 radians peak.

FREQUENCY MODULATION

Maximum FM Peak Deviation (2-digit LED display)²:

Center Frequency	Maximum Peak Deviation	
	AC Mode (the lesser of)	DC Mode
0.1 to 130 MHz	99 kHz or 4000 x rate (Hz)	99 kHz
130 to 260 MHz	50 kHz or 1000 x rate (Hz)	50 kHz
260 to 520 MHz	99 kHz or 2000 x rate (Hz)	99 kHz
520 to 1040 MHz	99 kHz or 4000 x rate (Hz)	99 kHz

FM not specified for $f_c - (\Delta f_{pk}) < 100$ kHz

Resolution: 100 Hz for deviations less than 10 kHz; 1 kHz for deviations ≥ 10 kHz.

FM Rate

Internal: 400 Hz and 1 kHz, ±2%.

External:

AC Coupled

5 Hz to 100 kHz, 3 dB bandwidth, 1 kHz reference.

20 Hz to 50 kHz, 1 dB bandwidth, 1 kHz reference.

DC Coupled

dc to 100 kHz, 3 dB bandwidth, 1 kHz reference.

dc to 50 kHz, 1 dB bandwidth, 1 kHz reference.

Center Frequency Accuracy in dc Mode:

Carrier Frequency	Center Frequency Accuracy
0.1 to 130 MHz	± 500 Hz
130 to 260 MHz	± 125 Hz
260 to 520 MHz	± 250 Hz
520 to 1040 MHz	± 500 Hz

Center Frequency Stability in dc Mode: <10 Hz per hour drift.

FM Distortion (at internal rates and ≥ 3 kHz peak deviations) ⁴: <0.5% THD plus noise.

Indicator Accuracy (internal rates): < ±5% of setting.

Incidental AM (peak deviations <20 kHz, internal rates and ≥ f_c 500 kHz): <0.1% AM

SUPPLEMENTAL CHARACTERISTICS

External Sensitivity: 1 volt peak for indicated accuracy (1 volt dc when in dc-FM mode).

External Modulation Input: Front panel BNC, 600 Ω dc-coupled; front panel annunciators indicate application of 1 V peak signal ± 5%.

Modulating Signal Output: Internal modulating signal is provided at the front panel BNC connector at nominally 1 volt peak into a 600 Ω resistive load.

Simultaneous Modulation:

Internal/External: AM/FM, FM/AM, AM/AM, FM/FM, Internal/Internal

External/External: AM/FM.

Table 1–2. HP 8657A Specifications (3 of 3)

REMOTE PROGRAMMING

Interface: HP-IB (Hewlett-Packard's implementation of IEEE Standard 488).

Interface Functions Implemented: SH0, AH1, T0, L2, SR0, RL1, PP0, DC1, DT0, C0, E1.

GENERAL

Operating Temperature: 0 to +55°C.

Storage Temperature: -40 to +70°C.

Humidity: Up to 95% Relative Humidity to 40°C.

EMC: Meets EN55011:1991 (Group 1, Class A), and EN50082-1:1992.

Save/Recall/Sequence Storage Registers:

100 non-volatile registers are available to save front panel settings.

Power Requirements: 100 or 120 or 220 or 240 Vac ($\pm 10\%$) from 48 to 440 Hz; 160VA maximum.

Weight: 17.0 kg nominal

Dimensions (height x width x depth):

145H x 426W x 505D mm nominal.

¹ Absolute level accuracy includes allowances for detector linearity, temperature, flatness, attenuator accuracy and measurement uncertainty.

² AM depth and FM deviation are further limited by Indicator Accuracy specifications.

³ For $f_c < 400$ kHz, AM depths of 0 to 30%, levels $\leq +7$ dBm.

⁴ FM distortion only specified for deviations up to 25 kHz for $130 < f_c < 260$ MHz, and for $260 < f_c < 520$ MHz. Typical total FM distortion (harmonic and non-harmonic) is less than 1.5% for all deviations and rates from dc to 100 kHz.

Table 1-3. HP 8657B Specifications (1 of 3)

SPECIFICATIONS describe the instruments warranted performance and apply after a 30 minute warm-up. All SPECIFICATIONS are valid over the signal generator's entire Operating/Environmental Range unless otherwise noted.

SUPPLEMENTAL CHARACTERISTICS (shown in italics) are intended to provide additional information useful in applying the instrument by giving typical (expected), but not warranted performance.

FREQUENCY

Range (10-digit LED display): 100 kHz to 2060 MHz.
 Resolution: 1 Hz.
 Switching Speed (to be within 1 dB of level and within 100 Hz of carrier frequency): <35 ms².
30 ms typical at 25°C.
 Accuracy and Stability: Same as time base used.

SUPPLEMENTAL CHARACTERISTICS
 Frequency Underrange: To 10 kHz with uncalibrated output and modulation.
 Phase Offset: Output signal phase is adjustable in 1 degree increments.

Timebase Characteristics:

	Standard	Option 001
Aging Rate	±2 ppm/year	1.0 x 10 ⁻⁹ /day after 45 days
Temperature (0-55°C)	±10 ppm	7 x 10 ⁻⁹
Line Voltage	—	2 x 10 ⁻⁹ (+5%, -10%)
Frequency	50 MHz	10 MHz
Timebase Reference Signal (Rear Panel)	Available at a level of >0.15 V _{rms} into 50 Ω (Output of 10, 5, or 1 MHz is selectable via internal jumper). If external reference is used, output will be the same frequency.	
External Reference Input (Rear Panel)	Accepts any 10, 5, or 1 MHz (±0.002%) input (Rear Panel) frequency standard at a level >0.15 V _{rms} into 50 Ω.	

SPECTRAL PURITY

Spurious Signals (≤+7 dBm output levels)¹:

Type of Spurious	Frequency (MHz)		
	0.1-1030	1030-1800	1800-2060
Harmonic	<- 30 dBc	<- 25 dBc	<- 25 dBc
Sub-harmonic	None	<- 40 dBc	<- 35 dBc

Nonharmonic Spurious:

Carrier Frequency	Carrier Offset	
	>5 kHz (Typical)	>2 MHz
0.1 to 130	<- 63 dBc	<- 60 dBc
130 to 260	<- 75 dBc	<- 60 dBc
260 to 520	<- 66 dBc	<- 60 dBc
520 to 1030	<- 63 dBc	<- 60 dBc
1030 to 2060	<- 57 dBc	<- 54 dBc

Residual FM in Hz rms (in CW mode):

Post Detection Bandwidth	Frequency Range (MHz)				
	0.1-130	130-260	260-520	520-1040	1040-2060
0.3 - 3 kHz	<4 Hz	<1 Hz	<2 Hz	<3 Hz	<6 Hz
0.05 - 15 kHz	<6 Hz	<1.5 Hz	<3 Hz	<4 Hz	<8 Hz
Typical Residual FM:					
0.3 - 3 kHz	<2 Hz	<0.5 Hz	<0.5 Hz	<1 Hz	<2 Hz
0.3 - 3 kHz (CCITT)	<1.25 Hz	<0.25 Hz	<0.25 Hz	<0.5 Hz	<1.0 Hz
0.05 - 15 kHz	<3 Hz	<1 Hz	<1 Hz	<1.5 Hz	<3 Hz

Residual AM (50 Hz to 15 kHz post-detection noise bandwidth, in CW mode): <0.04% AM.

SSB Phase Noise (in CW Mode):

Carrier Frequency	SSB ϕ-Noise 20 kHz offset	Typical 20 kHz offset
0.1 to 130 MHz	<- 124 dBc/Hz	<- 130 dBc/Hz
130 to 260 MHz	<- 136 dBc/Hz	<- 140 dBc/Hz
260 to 520 MHz	<- 130 dBc/Hz	<- 136 dBc/Hz
520 to 1040 MHz	<- 124 dBc/Hz	<- 130 dBc/Hz
1040 to 2060 MHz	<- 118 dBc/Hz	<- 123 dBc/Hz

SUPPLEMENTAL CHARACTERISTICS

Typical SSB Phase Noise

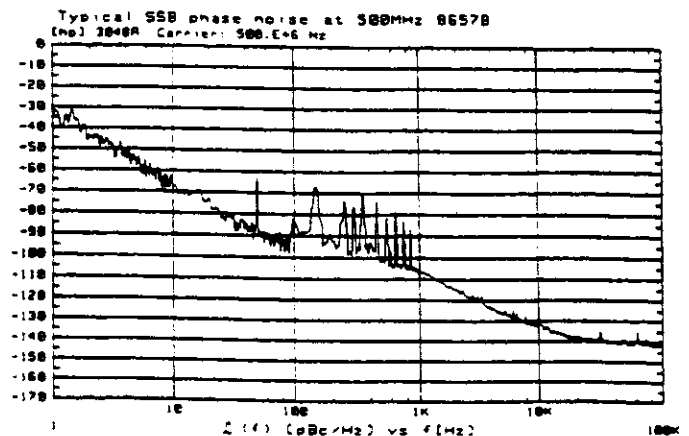

Table 1-3. HP 8657B Specifications (2 of 3)

OUTPUT

Level Range (3 1/2-digit LED display): +13 dBm to -143.5 dBm into 50Ω².

Resolution: 0.1 dB.

Absolute Level Accuracy³:

< ±1.0 dB (+3.5 to -127 dBm),

< ±1.5 dB (level >+3.5 dBm).

Level Flatness (100 kHz to 2060 MHz): ±0.5 dB,

output level setting of 0 dBm.

Reverse-Power Protection: Protects the signal generator from applications of up to 50 watts of RF power (from a 50Ω source) to 2060 MHz into generator output; DC voltage cannot exceed 25 V.

SUPPLEMENTAL CHARACTERISTICS

Attenuator Repeatability: 0.01 dB

Impedance: 50 Ω Nominal.

Output Level Overrange: To +17 dBm (frequencies >2 MHz)

Absolute level Accuracy: 1.5 dB, output levels ≤ -127 dBm.

SWR: <1.5 for levels ≤ -6.5 dBm.

<2.0 for levels ≤ +13 dBm.

AMPLITUDE MODULATION

AM Depth ($f_c > 400$ kHz⁴):

0 to 100%, level ≤ +7 dBm.

0 to 30%, level ≤ +10 dBm.

Resolution: 1%.

AM Rate Internal: 400 Hz and 1 kHz, ±2%.

External: 20 Hz to 40 kHz (1 dB bandwidth)

20 Hz to 100 kHz (3 dB bandwidth) Typical.

AM Distortion (at 400 Hz and 1 kHz rates, levels ≤ +7 dBm):

AM Depth	$f_c < 1030$	$f_c > 1030$
0 to 30 % AM ¹	1.5%	4%
31 to 70 % AM	3.0%	4%
71 to 90 % AM	4.0%	7%

1 For Opt. 003 AM depth ($f_c < 1030$ MHz): 31 to 70%, level is 4 %.

Indicator Accuracy (for depths <90%, 400 Hz and 1 kHz rates and levels ≤ +7 dBm): ±(6% of setting +2%).

Incidental Phase Modulation (at 30% AM depth, internal rates): 0.3 radians peak.

FREQUENCY MODULATION

Maximum FM Peak Deviation:

Center Frequency	Maximum Peak Deviation	
	AC Mode (the lesser of)	DC Mode
0.1 to 130 MHz	200 kHz or 4000 x rate (Hz)	200 kHz
130 to 260 MHz	50 kHz or 1000 x rate (Hz)	50 kHz
260 to 520 MHz	100 kHz or 2000 x rate (Hz)	100 kHz
520 to 1040 MHz	200 kHz or 4000 x rate (Hz)	200 kHz
1040 to 2060 MHz	400 kHz or 8000 x rate (Hz)	400 kHz

FM specified when peak deviation is > ($f_c + 100$ Hz)

FM Setting Resolution:

FM Deviation	Carrier Frequency	
	$f_c < 1040$ MHz	$f_c > 1040$ MHz
<100 kHz	100 Hz	200 Hz
>100 kHz	1 kHz	2 kHz

FM Rate Internal: 400 Hz and 1 kHz, ±2%.

External: (referenced to 1 kHz)

dc/5 Hz to 100 kHz, 3 dB bandwidth.

dc/20 Hz to 50 kHz, 1 dB bandwidth.

Center Frequency Accuracy in dc Mode:

Carrier Frequency	Center Frequency Accuracy
0.1 to 130 MHz	± 500 Hz
130 to 260 MHz	± 125 Hz
260 to 520 MHz	± 250 Hz
520 to 1040 MHz	± 500 Hz
1040 to 2060 MHz	± 1000 Hz

Center Frequency Stability in dc Mode: <10 Hz per hour drift.

FM Distortion (at 400 Hz and 1 kHz rates): <0.5% THD plus noise at deviations shown in the following table.

FM Distortion (at 400 Hz and 1 kHz rates):

Center Frequency	Deviation kHz
0.1 to 130 MHz	3 to 100 kHz
130 to 260 MHz	3 to 25 kHz
260 to 520 MHz	3 to 50 kHz
520 to 1040 MHz	3 to 100 kHz
1040 to 2060 MHz	6 to 200 kHz

Indicator Accuracy (400 Hz and 1 kHz): < 5% of setting
Incidental AM (peak dev. <20 kHz, 400 Hz and 1 kHz rates). <0.5% $f_c > 1030$ <0.1% AM, $f_c > 500$ kHz.

SUPPLEMENTAL CHARACTERISTICS

FM Distortion: Worst case distortion at all specified deviations, rates, and carrier frequencies is 1.5%.

External Sensitivity: 1 volt peak for indicated accuracy (1 volt dc when in dc-FM mode).

External Modulation Input: Front panel BNC, 600 Ω dc-coupled; front panel annunciators indicate 1 V peak signal ± 5%.

Modulating Signal Output: Internal modulating signal is provided at the front panel BNC connector at nominally 1 volt peak into a 600 Ω resistive load.

Simultaneous Modulation:

Internal/External: AM/FM, FM/AM, AM/AM, FM/FM, AM/FM/Pulse⁵

Table 1-3. HP 8657B Specifications (3 of 3)

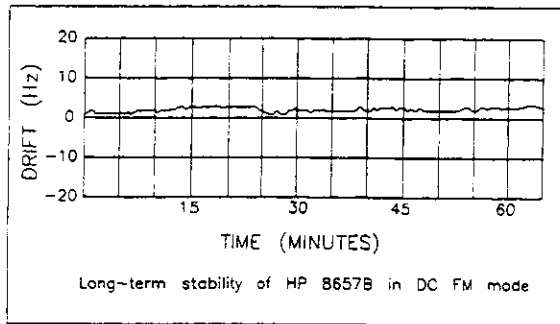
Long Term Carrier Stability in dc FM Mode.**PULSE MODULATION ⁵**

ON/OFF Ratio: >70 dB, $f_c \geq 130$ MHz.
>95 dB, $f_c \geq 1030$ MHz.

Rise/Fall Time: < 35 nanoseconds, $f_c \leq 130$ MHz
< 50 nanoseconds, $f_c \geq 1030$ MHz

Supplemental Characteristics:

Typical Rise/Fall Time: 10 ns, $f_c < 1030$ MHz;
18 ns, $f_c > 1030$ MHz.

Maximum Repetition Rate: DC - 30 MHz.

Level Accuracy: ± 1.0 dB absolute level accuracy in Pulse Mode.

Duty Cycle: 0 - 100%. (limited by rise/fall time)

Pulse Modulation Input: BNC, 50 ohms nominal or high impedance (internally selectable), can be driven directly by TTL.

Maximum Input Level: ± 15 V.

Nominal Input Threshold: 1.6 V.

Video Feedthrough: <15%.

Pulse Time Delay ⁶:

Off to On: 47 nanoseconds

On to Off: 34 nanoseconds

REMOTE PROGRAMMING

Interface: HP-IB (Hewlett-Packard's implementation of IEEE Standard 488).

Interface Functions Implemented: SH0, AH1, T0, L2, SR0, RL1, PP0, DC1, DT0, C0, E1.

GENERAL

Operating Temperature: 0 to +55°C.

Storage Temperature: -40 to +70°C.

Humidity: Up to 95% Relative Humidity to 40°C.

EMC: Meets EN55011:1991 (Group 1, Class A), and EN50082-1:1992.

Save/Recall/Sequence Storage Registers:

100 non-volatile registers are available to save front panel settings.

Power Requirements: 100 or 120 or 220 or 240 Vac ($\pm 10\%$) from 48 to 440 Hz; 200VA maximum.

Weight: 18.5 kg nominal

Dimensions (height x width x depth):

146H x 425W x 573D mm nominal.

¹ Spurious specifications apply for output levels $\leq +4$ dBm and $f_c < 1030$ MHz when pulse modulation is installed.

² Maximum output power is +10 dBm with pulse modulation installed at $f_c < 1030$ MHz.

³ Absolute level accuracy includes allowances for detector linearity, temperature, flatness, attenuator accuracy and measurement uncertainty.

⁴ When pulse modulation is installed, maximum specified output level in AM is reduced by 3 dB when $f_c < 1030$ MHz.

⁵ Pulse modulation specifications apply for carriers > 130 MHz and levels $\leq +7$ dBm (frequency switching speed typically increases by 30 ms with pulse modulation on). Additionally, AM is unspecified with pulse modulation turned on at $f_c \geq 1030$ MHz.

⁶ Time delay between a change in input pulse and carrier response.

⁷ Add 5 ms to amplitude switching setting when switching to $f_c \geq 1030$ MHz.

Table 1-4. Recommended Test Equipment (1 of 3)

Instrument Type	Critical Specifications	Recommended Model	Use ¹
AM/FM Test Source (required for Measuring Receiver verification)	Range: 10 MHz Residual AM ² FM Flatness: $\pm 1\%$ (dc to 250 kHz) Peak Deviation: to 100 kHz	HP 11715A	P
Audio Source	Level: 0.0 to 1 V _{pk} into 50 and 600 ohms Frequency: 25 Hz to 40 kHz	HP 8903B	P, A, T
Controller, HP-IB	HP-IB compatibility as defined as IEEE Standard 488 and the identical ANSI Standard MC1.1: SHO, E1, AH1, T4, TEO, LO, LEO, SRO, RLO, PPO, DCO, DTO, and C1, 2, 3, 28.	Use any HP controller and HP-IB interface to implement HP-IB functional checks	T
DC Power Supply	Output: 0-1 V Current: 500 mA	HP 6214C	A
Digital Multimeter	Accuracy: 4 1/2 digit, $\pm 0.05\%$ of reading ± 3 Ranges: 20 mV to 30 V _{dc} and 2 V _{ac} Sensitivity: 100 μ V	HP 3466A or HP 3455A (see Table 1-3)	P, A, T
Distortion Analyzer	Distortion Range: <0.1% Range: 20 Hz to 40 kHz	HP 8903B	P, T
Frequency Counter	Range: 1300 MHz Resolution: 1 Hz	HP 5328B Opt. 031	A, T
Pulse/Function Generator	Freq Range: 1 MHz to 50 MHz Function: Sine, Square, Pulse, etc. Output Level: 16 V _{pp} max into 600 ohms	HP 8116A	P
Function Generator	Frequency Range: 500 Hz Function: Square wave Output Level: 1 V _p into 600 ohms	HP 3312A	T
Loop Antenna	To ensure measurement accuracy, no substitution is possible. Fabrication depends upon machining and assembling to close tolerances.	HP 08640-60501	P
Measuring Receiver and Sensor Module	Frequency Range: 150 kHz to 1300 MHz Input Level: -127 to +13 dBm RF Power: 0.2 dB Tuned RF Level: 0.36 dB RSS Referenced to -10 dBm input	HP 8902A and 11722A (option 003 required for Residual FM Optional Performance Test)	P, A, T
¹ A = Adjustments; P = Performance Tests; T = Troubleshooting. ² The residual AM specification of both the HP 8902A Measuring Receiver and HP 11715A AM/FM Test Source are stated in a 50 Hz to 3 kHz bandwidth. In order to assure the validity of the residual AM measurement in the bandwidths stated for the Signal Generator (namely, 50 Hz to 15 kHz) the combined performance of both the HP 8902A and HP 11715A must be verified to be better than 0.022% rms for the 50 Hz to 15 kHz bandwidth.			

Table 1-4. Recommended Test Equipment (2 of 3)

Instrument Type	Critical Specifications	Recommended Model	Use ¹
Measuring Receiver and Sensor Module (Cont'd)	<p>Amplitude Modulation:</p> Rates: 25 Hz to 25 kHz Depth: to 99% Accuracy: Flatness: $\pm 0.5\%$ Demodulated Output Distortion: 0.3% for 50% depth; <0.6% for 90% depth Incidental ΩM : <0.05 radians for 50% depth at 1 kHz rate (50 Hz to 3 kHz bandwidth) Residual AM ² <p>Frequency Modulation:</p> Rates: 5 Hz to 100 kHz Deviation to 400 kHz Accuracy $\pm 2\%$ at 1 kHz Demodulated Output Distortion: <0.3% Incidental AM ³ Residual FM: <8 Hz rms at 1300 decreasing linearly with frequency to <1 Hz rms for 1000 MHz and below (50 Hz to 3 kHz bandwidth) <p>Audio Distortion:</p> Frequencies: 400 Hz and 1 kHz, $\pm 5\%$ Display Range: < 0.1% Accuracy: ± 1 dB of reading	HP 8902A and 17722A $\pm 2\%$ at 1 kHz	P, A, T
Oscilloscope and Probes	Vertical Sensitivity: 100 mV/div Pods: 54002A 50 Ω input 54003A 1M Ω input and 10:1 probe 54003-61617 Bandwidth: 50 MHz Time Base: .05 μ sec Input: Dual Channel	HP 54100A ⁴	P, A, T
<p>¹ A = Adjustments; P = Performance Tests; T = Troubleshooting.</p> <p>² The residual AM specification of both the HP 8902A Measuring Receiver and HP 11715A AM/FM Test Source are stated in a 50 Hz to 3 kHz bandwidth. In order to assure the validity of the residual AM measurement in the bandwidths stated for the Signal Generator (namely, 50 Hz to 15 kHz) the combined performance of both the HP 8902A and HP 11715A must be verified to be better than 0.022% rms for the 50 Hz to 15 kHz bandwidth.</p> <p>³ The incidental AM specification for the Signal Generator is not equivalent to the published specification of the HP 8902A Measuring Receiver. In order to assure the validity of the incidental AM measurement, the incidental AM of the modulation analyzer must be verified to be less than 0.002% for the 300 Hz to 20 kHz peak deviation at internal rates.</p> <p>⁴ See Table 1-6 for an alternate oscilloscope listing.</p>			

Table 1-4. Recommended Test Equipment (3 of 3)

Instrument Type	Critical Specifications	Recommended Model	Use ¹
Phase Noise Measurement System	Frequency Range: 0.1 to 1600 MHz Offset: 20 kHz Accuracy: ± 2 dB Noise Floor: -145 dB	HP 3048A	P
Reference Source	Frequency: 0.1 to 1600 MHz Level: +13 dBm SSB Phase Noise (20 kHz offset): < -124 dBc/Hz, 0.1 to 130 MHz < -136 dBc/Hz, 130 to 260 MHz < -130 dBc/Hz, 260 to 520 MHz < -124 dBc/Hz, 520 to 1040 MHz	HP 8657B or HP 8662A	P
Signal Source (optional)	Residual SSB phase noise in 1 Hz Bw (320 MHz $\leq f_c$ < 640 MHz) with an offset from the carrier of: -100 dBc at 10 Hz, -121 dBc at 1 kHz, and -131 dBc at 10 kHz	HP 8662A (for Optional Residual FM Test)	P
Signature Analyzer	Provides preferred method for troubleshooting digital circuitry	HP 5005A	T
Spectrum Analyzer, RF	Frequency Range: 0.1 to 2060 MHz Resolution Bandwidth: <1 kHz to 3 kHz	HP 8562B or HP 8555A/8552B/141T	P, A, T
SWR Bridge	Frequency Range: 5 MHz to 2060 MHz Impedance: 50 ohms Directivity: >40 dB Test Connector: Type N male	Wiltron 60N50	P
Wideband Amplifier	Gain: 20 or greater Frequency Range: 10 MHz to 1300 MHz Impedance: 50 ohms Connector: Type N	HP 8447D Option 010	P
Termination	Frequency Range: 0.1 to 2060 MHz Termination: 50 ohms SWR: <1.05	HP 908A	P

¹ A = Adjustments; P = Performance Tests; T = Troubleshooting.

Table 1-5. Recommended Accessories

Adapter/Cable	Quantity	Type	Recommended Model	Use ¹
Coaxial	1	BNC(f) to BNC(f)	HP 1250-0080	A, T
Coaxial	1	N(f) to BNC(m)	HP 1250-0077	A
Coaxial	3	N(m) to BNC(f)	HP 1250-0780	P, A, T
Probe	2	SMC(f) to RF Test Point	HP 1250-1598	A, T
RF	2	BNC(f) to SMC(f)	HP 08662-60075	P
RF	1	Connector: UG-21D/U Type N(m)	HP 11500A	P, A, T
RF	2	Connector: UG-21D/U Type N(m)	HP 11500B	P, A, T
RF	1	BNC to BANANA	HP 1100-60001	P
RF	2	BNC to BNC	HP 10503A or 8120-1840	P, A
PROBE	1	Alligator Clip to BNC	8120-1292	A

¹ A = Adjustments; P = Performance Tests; T = Troubleshooting.

Table 1-6. Alternate Test Equipment

Instrument	Recommended Model	Suggested Alternative	Advantages of Alternative
Digital Voltmeter (DVM)	HP 3466A	HP 3455A	HP-IB* Compatible
Oscilloscope	HP 54100A	HP 54110A	Availability

* HP-IB is Hewlett-Packard's implementation of IEEE Standard 488 and the identical ANSI Standard MC1.1

Section 2 INSTALLATION

2-1. INTRODUCTION

This section provides installation instructions for the Signal Generator. Included is information regarding initial inspection, power requirements, line voltage and fuse selection, power cables, time base selection, HP-IB address selection, interconnection, mating connectors, operating environment, rack mounting, storage, and shipment.

2-2. INITIAL INSPECTION

WARNING

To avoid hazardous electrical shock, do not apply power to the Signal Generator when there are any signs of shipping damage to any part of the Signal Generator.

Inspect the shipping container for damage. If the shipping container or cushioning material is damaged, it should be kept until the contents of the shipment have been checked for completeness and the Signal Generator has been checked mechanically and electrically. Procedures for checking electrical performance are given in Section 4. If the contents are incomplete, if there is mechanical damage or defect, or if the Signal Generator does not pass the electrical performance test, notify the nearest Hewlett-Packard office. If the shipping container is damaged, or the cushioning material shows signs of stress, notify the carrier as well as the Hewlett-Packard office. Keep the shipping materials for the carrier's inspection.

2-3. INSTALLATION CHECK LIST

Before connecting the Signal Generator to the line (mains) voltage, ensure the following steps are taken:

1. Read the warning on page 2-2, see **PREPARATION FOR USE**.
2. Check the line (mains) voltage to ensure compatibility with the Signal Generator's requirements, see **POWER REQUIREMENTS**.
3. Check that the voltage setting on the rear panel power line module is set to the correct voltage, see **LINE VOLTAGE SELECTION AND FUSE REPLACEMENT**.
4. Ensure that the rating of the line (mains) fuse is appropriate for the line voltage being used, see **TABLE 2-2**.
5. Ensure that the power cable is the correct type, see **POWER CABLES**.

2-4. PREPARATION FOR USE

WARNING

This is a Safety Class 1 product (i.e., provided with a protective earth terminal). An uninterruptible safety earth ground must be provided from the Mains power source to the product input wiring terminals, power cord, or supplied power cord set. Whenever it is likely that the protection has been impaired, the Signal Generator must be made inoperative and be secured against any unintended operation.

If this Signal Generator is to be energized via an external autotransformer for voltage reduction, make sure that the common terminal is connected to the earthed pole of the power source.

Before connecting the Signal Generator, the protective earth terminal of the Signal Generator must be connected to the protective conductor of the (Mains) power cord. The Mains plug shall only be inserted in a socket outlet provided with a protective earth contact. The protective action must not be negated by the use of an extension cord (power cable) without a protective conductor (grounding). Grounding one conductor of a two-conductor outlet is not sufficient protection.

2-5. POWER REQUIREMENTS



Table 2-1. Power Requirements

Model	Operating Voltage Range	Operating Frequency Range	Power Dissipation
HP 8657A	100/120/220/240V	48-440 Hz	160VA (max).
HP 8657B	100/120/220/240V	48-440 Hz	200VA (max).

2-6. LINE VOLTAGE SELECTION AND FUSE REPLACEMENT



Before switching on this instrument, make sure that the line voltage selector drum is set to the voltage of the power supply and the correct fuse is installed. Assure the power supply voltage is in the specified range.

Mains supply voltage fluctuations should not exceed $\pm 10\%$ of the nominal selected line voltage.

A rear-panel, line power module permits operation from 100, 120, 220, or 240 Vac. The number visible in the window (located on the module) indicates the nominal line voltage to which the Signal Generator must be connected. Verify that the Line Voltage Section Cam is matched to the power source. See Figure 2-1, Line Voltage Selection and Fuse Replacement. Table 2-2 lists the ratings of the line fuses.

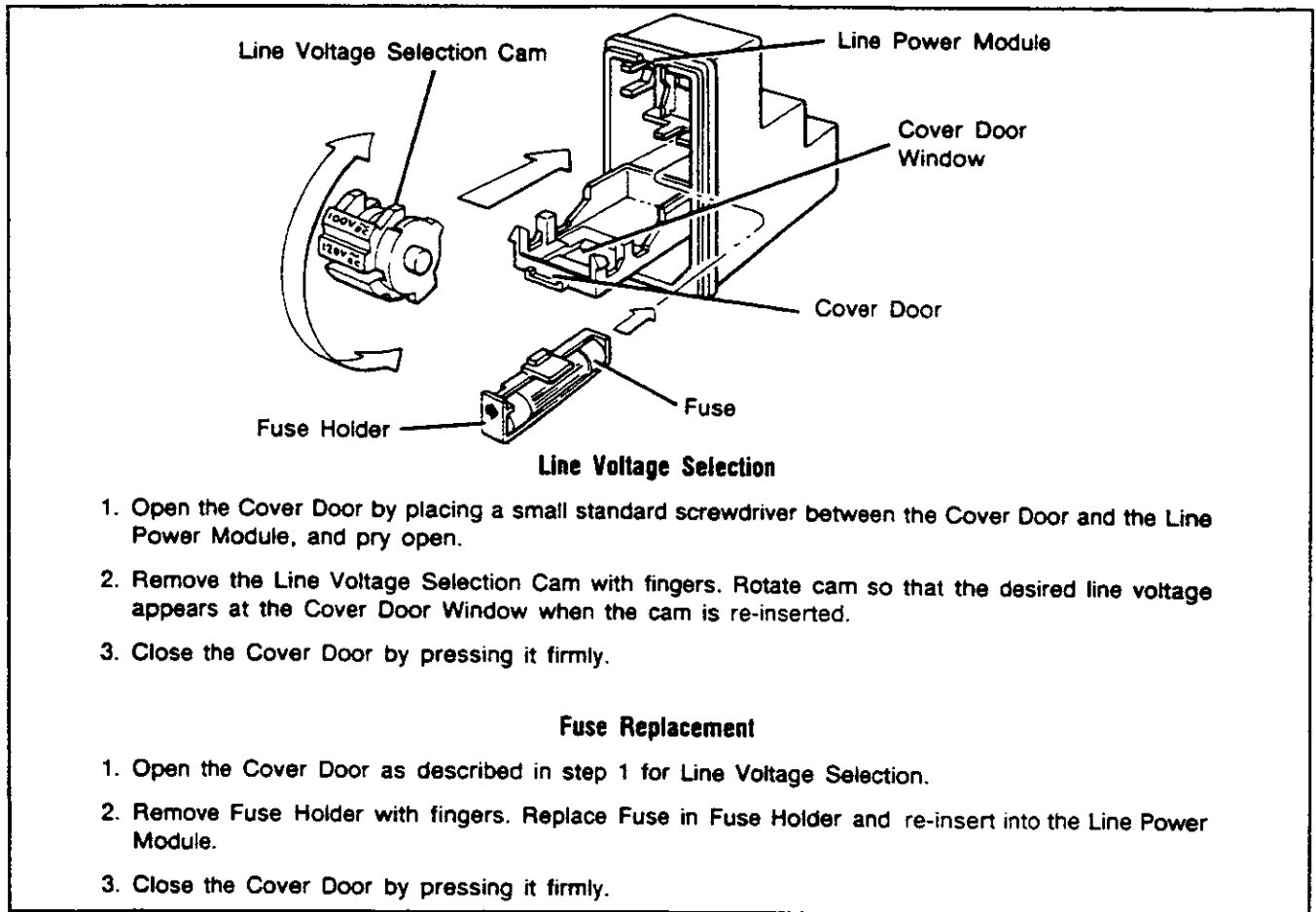

Figure 2-1. Line Voltage Selection and Fuse Replacement

WARNING

Appliance coupler (mains input powercord) is the power disconnect device. Do not position the instrument such that access to the coupler is impaired.

For continued protection against fire hazard, replace the line fuse only with the same type and line rating.

Table 2-2. Line Fuse Rating

Model	Line Voltage	Rating	HP Part Number
HP 8657A	100/120V	F1.5A 250V	2110-0304
	220/240V	F1.0A 250V	2110-0007
HP 8657B	100/120V	T2A 250V	2110-0303
	220/240V	T1.5A 250V	2110-0304

NOTE

To provide adequate cooling, an air gap of approximately 75mm should be maintained around the instrument.

2-7. POWER CABLES

This Signal Generator is equipped with a three-wire power cable. When connected to an appropriate ac power receptacle, this cable grounds the Signal Generator cabinet. The type of Mains plug shipped with each Signal Generator depends of the country of destinations. Refer to Table 2-3 for the power cables and Mains plugs available.

2-8. OPERATING ENVIRONMENT

This instrument is designed for Indoor use only.

The instrument may be operated at temperatures from 0°C to +55°C at altitudes up to 4600m (15,000 ft.). The instrument may be operated in environments up to 95% relative humidity to 40°C, but it should be protected from temperature extremes which may cause condensation.



This instrument is designed for use in Installation Category II and Pollution Degree 2 per IEC1010 and 644 respectively.

Cleaning

Use a soft, clean damp cloth to clean the front-panel and side covers.

Lifting and Carrying

Use either one of the handles on the side of the instrument for lifting or carrying the unit.

Before attempting to lift or carry the instrument consider the following basic lifting techniques to help avoid personal injury.

Using one arm to lift instrument.







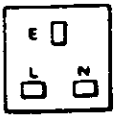

- BRACE your body with the opposite arm, if possible.
- REACH for the instrument - bend your knees and waist, and keep your back straight.
- GRASP the instrument firmly - using the handle.
- LIFT with your legs, using the free arm for balance.
- KEEP your shoulders level - switch hands regularly.

WARNING

If this instrument is not used as specified, the protection provided by the equipment could be impaired. This instrument must be used in a normal condition only (in which all means for protection are intact).

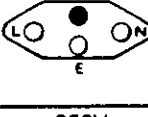
To prevent electrical shock always disconnect/isolate from mains supply before removing covers. Covers should only be removed as per the instructions given below. The rear panel power supply contains no operator serviceable parts. Do not remove rear panel. Refer all servicing to qualified personnel.

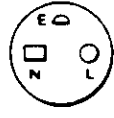
Table 2-3. Power Cable and Mains Plug Part Numbers

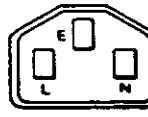
Plug Type	Cable HP Part Number	C D	Plug Description	Cable Length (inches)	Cable Color	For Use In Country
250V 	8120-1351 8120-1703	0 4	90°/STR BS1363A* 90°/90°	90 90	Mint Gray Mint Gray	United Kingdom, Cyprus, Nigeria, Rhodesia, Singapore
250V 	8120-1369 8120-0696	0 4	STR/STR NZSS198/ASC112* STR/90°	79 80	Gray Gray	Australia, New Zealand
250V 	8120-1689 8120-1692	7 2	STR/STR* STR/90°	79 79	Mint Gray Mint Gray	East and West Europe, Saudi Arabia, Egypt, (unpolarized in many nations)
125V 	8120-1378 8120-1521	1 6	STR/STR NEMA5-15P* STR/90°	80 80	Jade Gray Jade Gray	United States, Canada, Mexico, Phillipines, Taiwan
100V (Same plug as above)	8120-1751	1	STR/STR	90	Jade Gray	U.S./Canada
	8120-4753 8120-4754	2 3	STR/STR STR/90°	90 90	Dark Gray Dark Gray	Japan only Japan only
250V 	8120-2104	3	STR/STR SEV1011 1959-24507 Type 12	79	Gray	Switzerland
250V	8120-2296	4	STR/90°	79	Gray	
	8120-3997	4	STR/90°	177	Gray	
250V 	8120-0698	6	STR/STR NEMA6-15P	90	Black	United States, Canada
250V 	8120-2956 8120-2957 8120-3997	3 4 4	90°/STR 90°/90° STR/STR	79	Gray	Denmark
250V 	8120-4211 8120-4600	7 8	STR/STR*IEC83-B1 STR/90°	79 79	Black Gray	South Africa, India
250V 	8120-1860 8120-1575 8120-2191 8120-4379	6 0 8 8	STR/STR*CEE22-V1 (Systems Cabinet Use) STR/STR STR/90° 90°/90°	59 31 59 80	Jade Gray Jade Gray Jade Gray Jade Gray	

* Part number shown for plug is industry identifier for plug only. Number shown for cable is HP Part Number for complete cable including plug. E = Earth Ground; L = Line; N = Neutral; STR = Straight

2-9. TIME BASE SELECTION

This section provides information about selecting the frequency of the time base output signal and selecting the frequency that can be used as an external reference time base.

The time base output signal, which is available at the rear panel TIME BASE OUTPUT connector, can be set for a frequency of 1, 5 or 10 MHz. When the Signal Generator is shipped, the time base output is set to 10 MHz. If you require a 1 or 5 MHz time base output, follow the procedure detailed below.

If you want to use an external time base reference, you can use a 1, 5, or 10 MHz signal. The external time base signal is connected to the TIME BASE INPUT connector on the rear panel. When the Signal Generator is shipped, it is set to accept a 10 MHz signal. If you want to use either a 1 or 5 MHz external time base signal, follow the procedure detailed below.

When you select a timebase input or output frequency, the Signal Generator timebase output or timebase input, will be set for the same frequency.

WARNING

To prevent electrical shock always disconnect/isolate from mains supply before removing covers. Covers should only be removed as per the instructions given below. The rear panel power supply contains no operator serviceable parts. Do not remove rear panel. Refer all servicing to qualified personnel.

- a. Switch off the Signal Generator and remove the power cable.
- b. Remove the four screws which secure the strap handle and handle caps. Remove the top cover.
- c. Refer to Figure 2-2. Locate the A3 50 MHz Reference Oscillator. Using a 1/4 inch wrench (spanner), slacken the eight retaining nuts (2 per side) which secures the top cover. Then remove the top cover. Locate the time base selection link.
- d. Unsolder the end of the selection link and resolder it in the appropriate position for the time base output or the external time base signal you require.
- e. Reassemble the Signal Generator by reversing the procedure given in step c and then in step b.

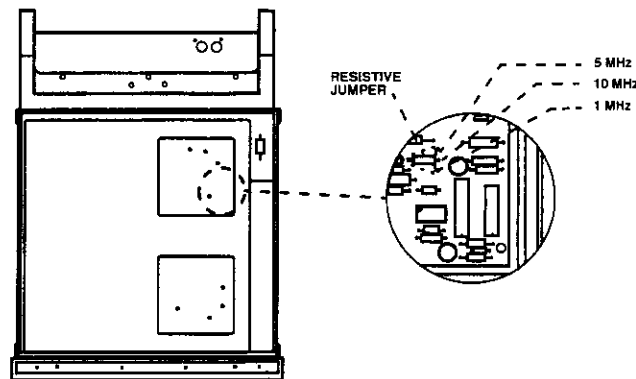

Figure 2-2. Time Base Jumper Location (A 3 Board)

2-10. HEWLETT-PACKARD INTERFACE BUS (HP-IB)

This section contains information about installing the Signal Generator into a Hewlett-Packard Interface Bus (HP-IB) System.

The HP-IB is Hewlett-Packard's implementation of the IEEE Standard 488-1978 (Digital Interface for Programmable Instrumentation). This standard defines a physical interface and protocol which enables the remote control of instrumentation systems.

2-11. HP-IB ADDRESS SELECTION

The HP-IB address of the Signal Generator is factory set to 07 (decimal). You can set the HP-IB address to any one of 31 valid addresses in the range 00 to 30 (decimal). If you want to set the HP-IB address to another value, use the following procedure.

WARNING

To prevent electrical shock always disconnect/isolate from mains supply before removing covers. Covers should only be removed as per the instructions given below. The rear panel power supply contains no operator serviceable parts. Do not remove rear panel. Refer all servicing to qualified personnel.

HP 8656B/8657A

- Switch off the Signal Generator and remove the power cable.
- Remove the four screws which secure the strap handle and handle caps. Remove the bottom cover.
- Locate the HP-IB address switches S2 and S3 on the All Microprocessor/Memory/HP-IB Assembly (see Figure 2-3).
- Use a pointed object (such as a pencil) to set the switches to the desired HP-IB address in binary (see Figure 2-3). The five switches are labeled A1 through A5, where A1 is the least significant address bit and A5 is the most significant address bit. Pressing the right-hand side of the switch (as viewed from the front of the Signal Generator) "sets" the corresponding address bit (bit = 1), while pressing the left-hand side "clears" the bit (bit = 0). Setting all of the address bits to "1" will result in an invalid HP-IB address (31 decimal). In this case, an HP-IB address of 30 (decimal) is stored in memory once the Signal Generator is powered up.
- Replace the bottom cover by reversing the procedure given in step b.
- Plug in the Signal Generator and switch on.
- To confirm the HP-IB address, press the SHIFT key, and hold the LOCAL key. The decimal HP-IB address is displayed in the MODULATION Display as long as the LOCAL key remains pressed.

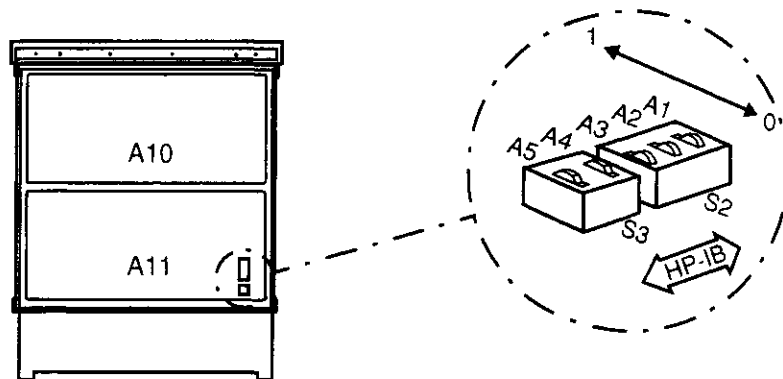

Figure 2-3. HP 8656B/8657A HP-IB Address Switch Location and Settings

HP 8657B

- a. Switch off the Signal Generator and remove the power cable.
- b. Remove the four screws which secure the strap handle and handle caps. Remove the bottom cover.
- c. Refer to Figure 2-4. Locate the HP-IB address switch S1 on the A13 Microprocessor assembly.
- d. Using table 2-4 as a reference, set S1 to the HP-IB address you require. For example to set the HP-IB address to 03 (decimal), switch segments A1 and A2 would be set to open and switch segments A3, A4 and A5 would be set to closed.

CAUTION

Change only the switch segments marked A1 thru A5. The remaining switch segments are used to invoke built-in service utilities. Changing the position of these switch segments could prevent the HP 8657B from operating correctly.

- e. Replace the bottom cover by reversing the procedure given in step b.
- f. Plug in the HP 8657B and switch on.
- g. To confirm the HP-IB address, press the SHIFT key, and hold the LOCAL key. The decimal HP-IB address is displayed in the MODULATION Display as long as the LOCAL key remains pressed.

2-12. CONNECTION TO THE HP-IB

The HP-IB connector on the rear panel, provides the interface to connect the Signal Generator into an HP-IB system. Refer to Figure 2-5 for information about the connector.

HP-IB Cables, The following HP-IB cables are available:

- HP 10833A (1m, 3.3ft)
- HP 10833B (2m, 6.6ft)
- HP 10833C (4m, 13.2ft)
- HP 10833D (0.5m, 1.6ft)

Cabling Restrictions, devices in an HP-IB system can be connected in any suitable arrangement (star, delta, etc). However the following cabling restrictions must be observed:

- The HP-IB system must contain no more than 2 metres (6.6 ft.) of connecting cable per device.
- The maximum accumulative length of connecting cable for the HP-IB system is 20 metres (65.6 ft.).

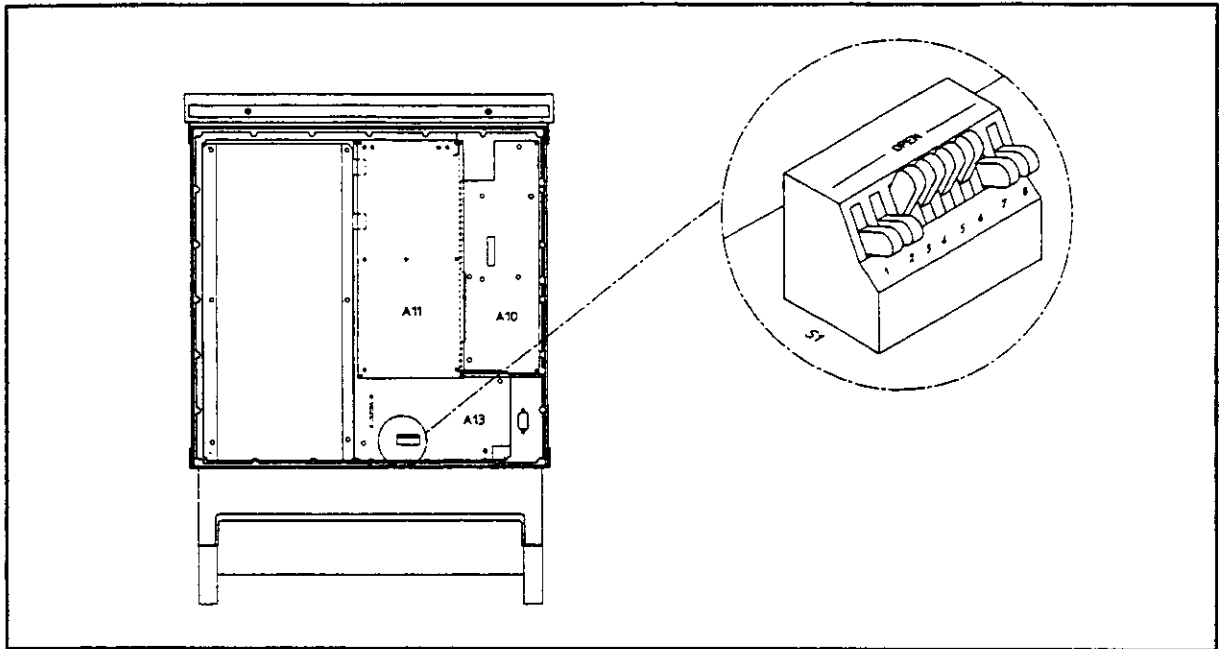

Figure 2-4. HP 8657B HP-IB Address Switch Location

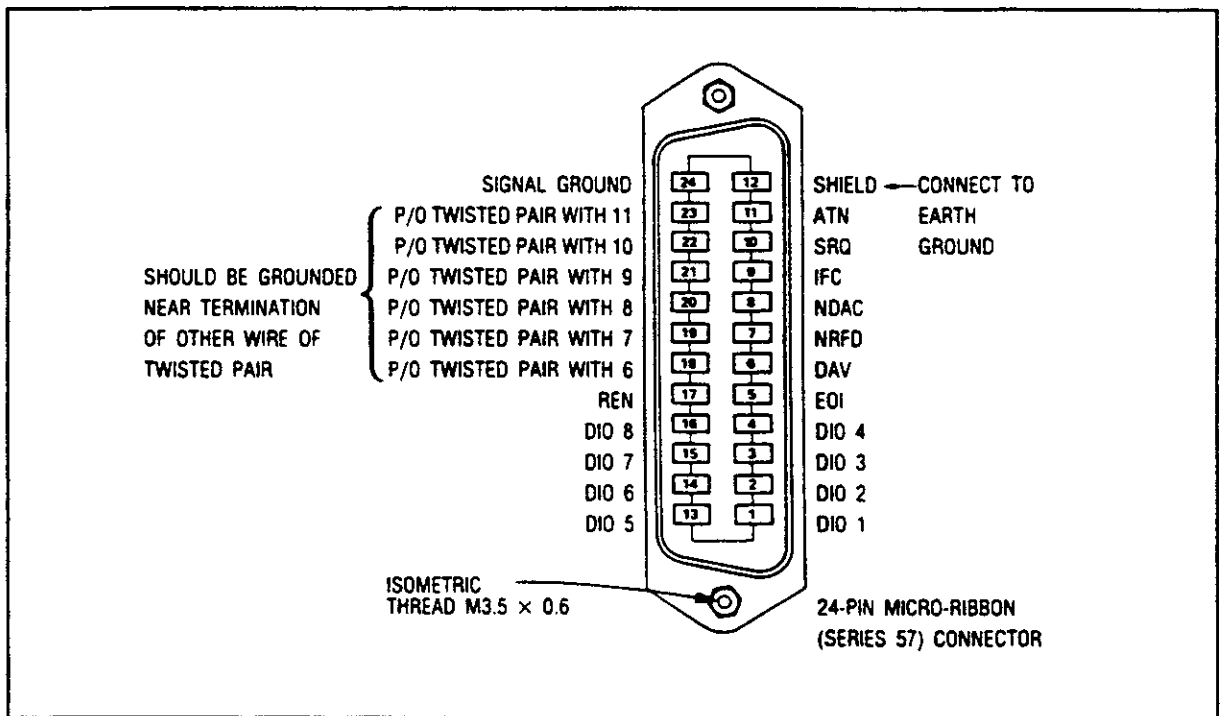

Figure 2-5. HP-IB (rear panel) connector

Table 2-4. HP-IB Address Codes

Address Switch					Equivalent ASCII Character (LISTEN)	Equivalent Decimal Value (LISTEN)
A5	A4	A3	A2	A1		
0	0	0	0	0	SP	00
0	0	0	0	1	!	01
0	0	0	1	0	"	02
0	0	0	1	1	#	03
0	0	1	0	0	\$	04
0	0	1	0	1	%	05
0	0	1	1	0	&	06
0	0	1	1	1	'	07 ⁽¹⁾
0	1	0	0	0	(08
0	1	0	0	1)	09
0	1	0	1	0	*	10
0	1	0	1	1	+	11
0	1	1	0	0	,	12
0	1	1	0	1	-	13
0	1	1	1	0	.	14
0	1	1	1	1	/	15
1	0	0	0	0	0	16
1	0	0	0	1	1	17
1	0	0	1	0	2	18
1	0	0	1	1	3	19
1	0	1	0	0	4	20
1	0	1	0	1	5	21
1	0	1	1	0	6	22
1	0	1	1	1	7	23
1	1	0	0	0	8	24
1	1	0	0	1	9	25
1	1	0	1	0	:	26
1	1	0	1	1	;	27
1	1	1	0	0	<	28
1	1	1	0	1	=	29
1	1	1	1	0	>	30

(1) Factory-set address.

2-13. COAXIAL CONNECTORS.

Coaxial mating connectors used with the Signal Generator should be either 50-ohm BNC male connectors or 50-ohm Type N male connectors that are compatible with those specified in US MIL-C-39012.

2-14. TIMEBASE LOOPING CABLE (OPTION 001 ONLY)

The coaxial Timebase Looping cable, supplied with Option 001, should be connected between the HIGH STABILITY TIME BASE OUTPUT connector and the TIME BASE INPUT connector on the rear panel of the Signal Generator.

2-15. PULSE MODULATION INPUT IMPEDANCE (HP 8657B OPTION 003 OR 004 ONLY)

You can set the input impedance of the Pulse Modulation Input to 50 ohms or high impedance. The input impedance is set to high impedance when the HP 8657B is shipped. To change the input impedance use the following procedure:

WARNING

To prevent electrical shock always disconnect/isolate from mains supply before removing covers. Covers should only be removed as per the instructions given below. The rear panel power supply contains no operator serviceable parts. Do not remove rear panel. Refer all servicing to qualified personnel.

- a. Switch off the HP 8657B and remove the power cable.
- b. Remove the four screws which secure the strap handle and handle caps. Remove the bottom cover.
- c. Refer to Figure 2-6. Locate the selection link W1. When this is set to position 1, the input impedance is set to 50 ohms; when it is set to position 2, the input impedance is set to high impedance. Set W1 into the position you require.
- d. Replace the bottom cover by reversing the procedure in step b.

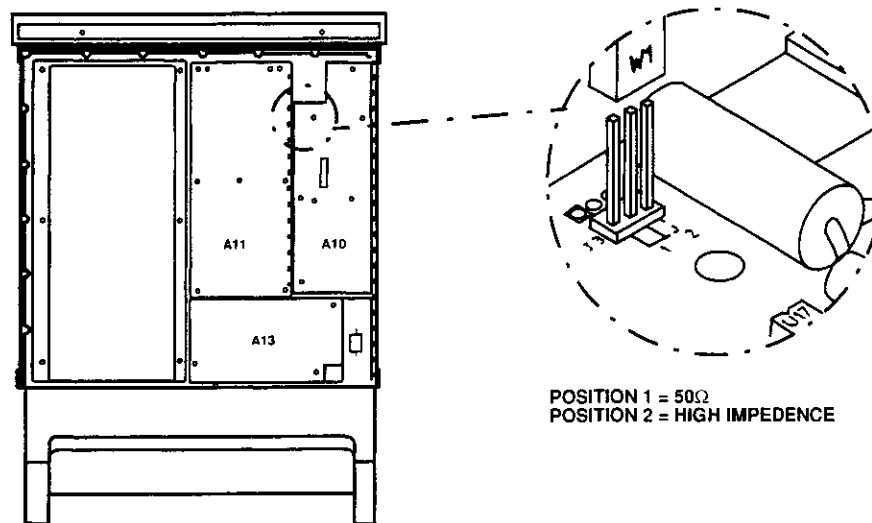

Figure 2-6. Pulse Modulation Input impedance selection

2-16. BENCH OPERATION

The instrument cabinet has plastic feet and foldaway tilt stands for convenience in bench operation. (The plastic feet are shaped to ensure self-alignment of instruments when they are stacked.) The tilt stands raise the front of the Signal Generator for easier viewing of the front-panel.

2-17. RACK MOUNTING

NOTE

The HP 8656B and HP 8657A each weigh 18.2 kg (40 lb). The HP 8657B weighs 20.5 kg (45 lb). Care must be exercised when lifting to avoid personal injury. Use equipment slides when rack mounting.

Rack mounting information is provided with the rack mounting kits. If a kit was not ordered with the Signal Generator as an option, it may be ordered through the nearest Hewlett-Packard office. Slide rack mount kits are discussed in the following paragraphs; refer to paragraph 1-6, Mechanical Options, in Section 1 for information and part numbers pertaining to other rack mount kits.

Slide rack mount kits allow the convenience of rack mounting with the flexibility of easy access. The slide kits for the Signal generator are listed below.

Standard Slide Kit for HP rack enclosures	HP 1494-0060
Special Tilt Slide Kit for HP rack enclosures	HP 08656-82001
Slide Adapter Bracket Kit for Standard Slides (for non HP rack enclosures)	HP 1494-0061

2-18. INTERNAL BATTERY

WARNING

This product uses a lithium battery which may explode if mishandled. DO NOT recharge or disassemble the battery, and do not dispose of it by burning. Check your local country regulatory requirements for the disposal of lithium batteries. When the battery needs replaced, use only the battery listed in Section 6 of the appropriate Service Manual.

The lithium battery on the Processor board, which is used as a power supply for the non volatile memory, should be replaced at approximately 3 year intervals.

When the battery needs replaced, the HP 8656B and HP 8657A will display decimal points in the frequency window, at power on. The HP 8657B will display **CLEARING** in the frequency window, at power on. Refer to the Service Manual for information about replacing the battery.

NOTE

You can still use all the features of the Signal Generator except for Storing and Recalling front-panel set-ups, when the battery needs replaced. However, it is recommended that you replace the battery as soon as the error occurs.

2-19. STORAGE AND SHIPMENT

Environment

The Signal Generator should be stored in a clean, dry environment. The following environmental limitations apply to both storage and shipment.

Temperature.....	-40° C to + 70° C
Humidity.....	< 95% relative
Altitude	15,300 meters (50,000 feet)

Packaging

Original Packaging. Containers and materials identical to those used in factory packaging are available through Hewlett-Packard offices. If the Signal Generator is being returned to Hewlett-Packard for servicing, attach a tag indicating the type of service required, return address, model number, and full serial number. Also, mark the container **FRAGILE** to assure careful handling. In any correspondence, refer to the Signal Generator by model number and full serial number.

Other Packaging. The following general instructions should be used for repackaging with commercially available materials.

- a. Wrap the Signal Generator in heavy paper or plastic. (If shipping to a Hewlett-Packard office or service center, attach a tag indicating the type of service required, return address, model number, and full serial number.)
- b. Use a strong shipping container. A double-wall carton made of 2.4 MPa (350 psi) test material is adequate.
- c. Use enough shock-absorbing material (75 to 100 millimeter layer; 3 to 4 inches) around all sides of the Signal Generator to provide a firm cushion and to prevent movement in the container. Protect the front-panel with cardboard.
- d. Seal the shipping container securely.
- e. Mark the shipping container **FRAGILE** to assure careful handling.

2-20. Internal Fuses

The fuses used on circuit boards within the instrument are listed below and are **non-operator replaceable**.

Fuse	8657A			8657B		
	Current	Voltage	Type	Current	Voltage	Type
F1	1.0A	250V	F	3.0A	250V	F
F2	1.5A	250V	F	6.0A	250V	F
F3	1.5A	250V	F			
F4	5.0A	250V	F			

WARNING

To prevent electrical shock always disconnect/isolate from mains supply before removing covers. Covers should only be removed as per the instructions given below. The rear panel power supply contains no operator serviceable parts. Do not remove rear panel. Refer all servicing to qualified personnel.

Section 3 OPERATION

3-1. INTRODUCTION

This section provides complete operating information for the Signal Generator. The information contained in this section is detailed below.

3-2. LOCAL OPERATION

Information covering front-panel operation of the Signal Generator is contained in this section and in the separate Quick Reference Guide.

Quick Reference Guide This separate booklet aims to get you ready to use the Signal Generator. It takes you through switch-on, introduces the Signal Generator's features and how to set them and provides simple procedures to demonstrate how easy the Signal Generator is to use.

Detailed Operating Instructions (refer to page 3-17). The detailed operating instructions provide comprehensive information about all of the Signal Generator functions and features. Table 3-8 is an index (in functional order) to the detailed operating instructions.

3-3. REMOTE OPERATION (HP-IB)

If you have a suitable controller, the Signal Generator can be operated remotely via the Hewlett-Packard Interface Bus (HP-IB). If you are not familiar with the HP-IB, you may want to refer to the document "Tutorial Description of the HP-IB", HP part number 5952-0156.

HP-IB information for the Signal Generator is contained in the following areas of this section:

- a. General HP-IB information begins with paragraph 3-5.
- b. A summary of HP-IB capabilities is provided in Table 3-7.
- c. A summary of program codes is provided in Tables 3-4 and 3-5.
- d. Detailed information relating to the Signal Generator HP-IB programmable features together with tables and examples of associated program codes, are provided in the detailed operating instructions at the end of this section.

3-4. USER CONFIDENCE TESTS

The User Confidence Tests provide procedures to allow you to check that the Signal Generator is operating correctly, in both local and remote modes. Refer to page 3-71.

3-5. REMOTE OPERATION, HEWLETT-PACKARD INTERFACE BUS

The Signal Generator can be operated through the Hewlett-Packard Interface Bus (HP-IB). Bus compatibility, programming, and data formats are described in the following paragraphs.

All front-panel functions (except for DSPL, DSPL in conjunction with SEQ, display Amplitude Offset, Backspace (←), COARSE TUNE, FINE TUNE, clearing the NVM and displaying the HP-IB address) are programmable through HP-IB.

A quick check of the Signal Generator HP-IB input/output capability is described in paragraph 3-12, HP-IB Functional Checks. These checks can be used to verify that the Signal Generator responds correctly to the HP-IB messages described in Table 3-7.

HP-IB Compatibility

The Signal Generator has an open-collector, TTL, HP-IB interface. The Signal Generator can be used with any HP-IB computing controller or computer for automatic system applications. The Signal Generator is fully programmable via the HP-IB. The Signal Generator programming capability is described by the 13 HP-IB messages listed in Table 3-7. Foremost among these messages is the Data message. Data messages contain the program codes that control the Signal Generator output signal. The Signal Generator's complete compatibility with HP-IB is further defined by the following list of interface functions: SH0, E1, AH1, T0, L2, SR0, RL1, PP0, DC1, DT0, and C0. A more detailed explanation of these compatibility codes can be found in the IEEE Standard 488 (and the identical ANSI Standard MC1.1). For more information about HP-IB, refer to the Hewlett-Packard Electronic Instruments and Systems catalog and the booklet titled "Tutorial Description of the HP-IB" (HP part number 5952-0156).

Remote Operation

Remote Capability. In remote operation, the front-panel keys are disabled (except for the POWER switch and the LOCAL key). The Signal Generator can only be addressed to listen. When addressed to listen, the Signal Generator responds to the following messages: Data, Clear, Remote, Local, Local Lockout, Clear Lockout/Set Local, and Abort. Each is discussed in detail further on in this section.

Local-to-Remote Change. The Signal Generator switches to remote operation when the Remote message is received. The Remote message is comprised of two parts. They are:

- Remote Enable bus control line (REN) set true.
- Device listen address received once (while REN is true).

The Signal Generator RMT and ADRS annunciators will both light, and its output signal and all preselected functions remain unchanged when the local-to-remote transition occurs.

Local Operation

Local Capability. In local operation, the Signal Generator front-panel is fully operational, and will respond to the Remote message. Whether addressed or not, the Signal Generator also responds to the Clear, Local Lockout, Clear Lockout/Set Local, and Abort messages. It will not, however, respond to the Data message unless it has been previously addressed.

Remote-to-Local Change. The Signal Generator returns to local operation when the Local message (GTL) or Clear Lockout/Set Local message is received. The Clear Lockout/Set Local message sets the Remote Enable bus control line (REN) false. The Signal Generator can always be set to local operation by pressing the front-panel LOCAL key, provided that local lockout is not set. The output signal remains unchanged, and all preselected functions remain unchanged when the remote-to-local transition occurs.

Local Lockout. When a data transmission is interrupted, which can happen if the Signal Generator is returned to local operation by pressing the LOCAL key, the data could be lost. This would leave the Signal Generator in an unknown state. To prevent this, a local lockout is recommended. Local lockout disables the LOCAL key and allows return-to-local only under program control.

NOTE

Return-to-local can also be accomplished by setting the POWER switch to STBY, and then back to ON. This technique, however, has some potential disadvantages.

It defeats the purpose and advantage of local lockout, since the system controller will lose control of the Signal Generator.

Some HP-IB conditions are reset to their default state during turn on.

Addressing

The Signal Generator interprets the byte of information on its eight data input/output bus lines as either an address or a bus command. Whenever the bus is in the command entry mode, the Attention bus control line (ATN) is true and the Interface Clear bus control line (IFC) is false. Whenever the Signal Generator is being addressed (whether in local or remote operation), the front-panel ADRS annunciator will light.

The Signal Generator listen address is set by an internal switch. The address selection procedure is described in Section 2, Installation. The decimal equivalent of the listen address can be displayed in the MODULATION Display by pressing the SHIFT key first and then pressing and holding the LOCAL key. Refer to Table 3-1 for a list of the valid decimal (listen address) values and their equivalent ASCII characters.

Table 3-1. Valid Decimal Values vs. Equivalent ASCII Characters

Equivalent Decimal Value (Listen)	Equivalent ASCII Character (Listen)	Equivalent Decimal Value (Listen)	Equivalent ASCII Character (Listen)
00	SP	16	0
01	!	17	1
02	"	18	2
03	#	19	3
04	\$	20	4
05	%	21	5
06	&	22	6
07 ⁽¹⁾	'	23	7
08	(24	8
09)	25	9
10	*	26	:
11	+	27	;
12	,	28	<
13	-	29	=
14	.	30	>
15	/		

(1) Factory-set address.

Data Messages

The Signal Generator communicates on the interface bus with Data messages. Each Data message consists of one or more bytes of information sent over the eight data input/output bus lines DIO1 through DIO8 during the data entry mode. The data entry mode is established when the Attention bus control line (ATN) is false. Data messages include the program codes listed in Tables 3-4 and 3-5. These program codes contain the necessary information to program virtually all of the Signal Generator functions available in local operation. The only exceptions are DSPL, DSPL in conjunction with SEQ, display Amplitude Offset, Backspace, COARSE TUNE, FINE TUNE, and display HP-IB ADRS.

Receiving the Data Message

The Signal Generator must be in remote operation and addressed to listen before it can respond to Data messages. The Signal Generator remains addressed to listen until it receives an Abort message or a universal unlisten command from the controller.

The paragraph entitled Switching Characteristics, shows how the Signal Generator responds to Data Messages. Timing considerations and other characteristics pertinent to operation are included.

Data Message Input Format. Data messages contain the controller's talk address, the Signal Generator listen address, a string of program codes, and an End of String message (EOS). The string of program codes follows the same protocol as a front-panel keystroke sequence in local operation. The EOS message can be a Line Feed (LF), a bus END message (EOI and ATN bus control lines both set true), or an internally produced EOS.

The following paragraphs explain other key elements of the program code strings. Figure 3-1 provides some examples of Data messages.

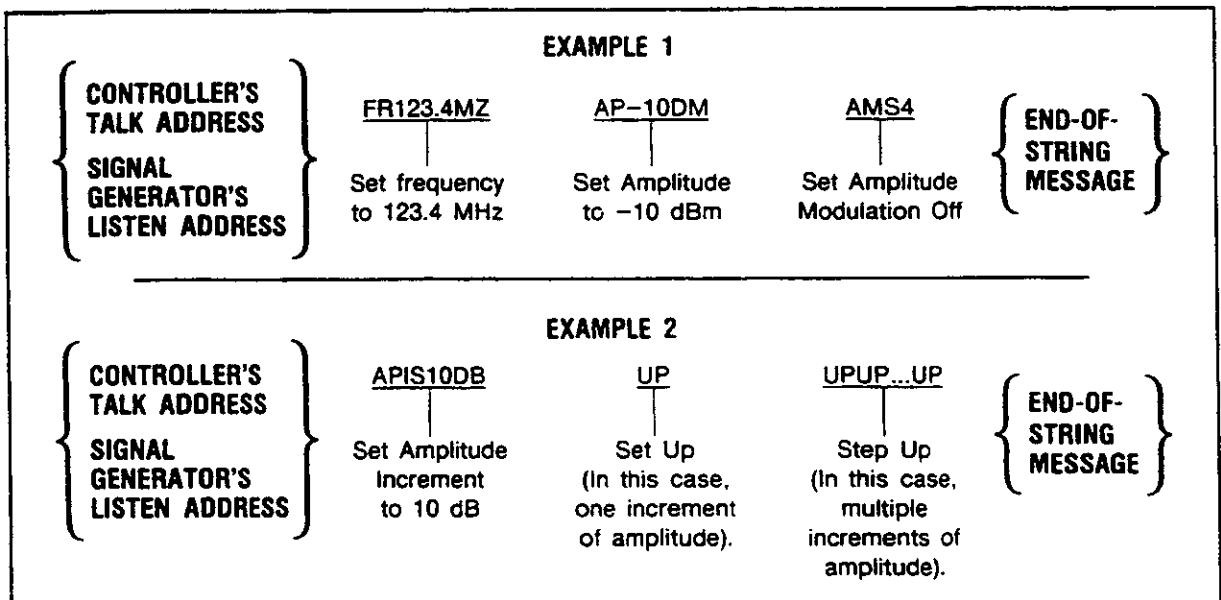

Figure 3-1. Data Message Example.

NOTE

After any function terminator (UNITS entry) is sent to the Signal Generator, the Signal Generator is unable to respond to the interface bus until the microprocessor has completed execution of the particular task. Any attempt to send data to the Signal Generator delays bus operation until the execution is complete. The normal terminators carriage-return, and line-feed are considered further data. Data cannot be sent on the bus until the Signal Generator has processed the carriage-return, and line-feed. The bus is free, however, for communication between controller and other equipment. It is recommended that the carriage-return, and line-feed be omitted from data messages sent to the Signal Generator by using a semicolon after the function terminator.

Keyboard-to-Program Code Correlation. There is a program code that corresponds to nearly every front-panel key. The exceptions are DSPL, DSPL in conjunction with SEQ, display Increment Set, Backspace, COARSE TUNE, FINE TUNE, and display HP-IB ADRS. In addition, the program code HZ is available for carrier frequency entries, RP is available to reset the reverse power protection circuitry after the source of reverse power has been removed, and R0 and R1 are available to place the Signal Generator in the STBY and ON states, respectively.

Value-Selectable Parameters. Carrier parameters are set using a Function-Data-Units sequence of program codes, while modulation parameters are set using a Source-Function-Data-Units sequence of program codes. Single-value parameters; such as, INT 400 Hz, INT 1 kHz, and so forth, are set with a single program code sequence.

Data. The term "Data" in each program sequence refers to the numeric value and not to the entire Data message. Data can be any number of arbitrary length in fixed point notation. Digits that exceed the maximum data length for the particular function will be truncated. This maximum limit includes any embedded decimal points. In the case of the Amplitude function, this maximum limit also includes the minus sign. The minus sign is only applicable during Amplitude Data entries. Table 3-2a and Table 3-2b summarizes these input data restrictions. A complete list of ASCII characters with conversions to binary, octal, decimal, and hexadecimal is provided in Table 3-6.

Table 3-2a. Input Data Restrictions (HP 8656B/57A)

Function	Maximum Data Length	Decimal Point Allowed	Minus Sign Allowed
Frequency	9 Digits	Yes	No
Amplitude	9 Digits (1)	Yes	Yes
AM	2 Digits	Yes	No
FM	2 Digits	Yes	No
Increment Set	Same as for selected function	Yes	No
<p>NOTES:</p> <ol style="list-style-type: none"> In the Amplitude function, leading zeros are not counted. Unused or unidentifiable characters are ignored. Either upper or lower case letters can be used in Data messages. Only the following ASCII characters are recognized by the HP 8656B/57A: A-Z a-z 0-9 LF - % All other characters, including spaces, are ignored. 			

Table 3-2b. Input Data Restrictions (HP 8657B)

Function	Maximum Data Length	Decimal Point Allowed	Minus Sign Allowed
Frequency	10 Digits	Yes	No
Amplitude	9 Digits (1)	Yes	Yes
AM	3 Digits	Yes	No
FM	3 Digits	Yes	No
Increment Set	Same as for selected function	Yes	No
<p>NOTES:</p> <ol style="list-style-type: none"> 1. In the Amplitude function, leading zeros are not counted. 2. Unused or unidentifiable characters are ignored. 3. Either upper or lower case letters can be used in Data messages. 4. Only the following ASCII characters are recognized by the HP 8657B: A-Z a-z 0-9 LF - . % All other characters, including spaces, are ignored. 			

Sending the Data Message

The Signal Generator does not have the capability to talk; therefore, it cannot send Data messages.

Receiving the Trigger Message

The Signal Generator does not have the capability to respond to the trigger message.

Receiving the Clear Message

The Signal Generator responds to a Clear message by setting each function parameter to the value listed in Table 3-3. The Signal Generator responds equally to the Selected Device Clear (SDC) bus command when addressed to listen, and to the Device Clear (DCL) bus command whether addressed or not.

Table 3-3. Response to Clear Message.

Parameter	Value
Carrier Frequency	100.00000 MHz
Output Amplitude	-143.5 dBm ¹
AM Depth	0%
FM Peak Deviation	0.0 kHz
Carrier Frequency Increment	10.00000 MHz
Output Amplitude Increment	10.0 dB
AM Depth Increment	1%
FM Peak Deviation Increment	1.0 kHz
Coarse and Fine Tune Pointer	10.00000 MHz
Sequence Counter	0
100 Saved Set Ups	Remain unchanged
¹ HP 8656B will set to -127 dBm.	

Receiving the Remote Message

The Remote message is comprised of two parts. First, the Remote Enable bus control line (REN) is held true, then the device listen address is sent by the controller. These two actions combine to place the Signal Generator into remote operation. Therefore, the Signal Generator is enabled to go into remote operation when the controller begins the Remote message, but it does not actually make the transition until it is addressed to listen for the first time. All Signal Generator settings remain unchanged when the transition from local-to-remote operation occurs. The front-panel RMT and ADRS annunciators will both light once the Signal Generator has received the Remote message and is addressed to listen.

Receiving the Local Message

The Local message is the means by which the controller sends the Go to Local (GTL) bus command. If addressed to listen, the Signal Generator returns to local operation (full front-panel control) when it receives the Local message. If the Signal Generator is in local lockout when the Local message is received, full front-panel control is returned, but local lockout remains in effect. Unless the Signal Generator receives the Clear Lockout/Set Local message, it returns to local lockout the next time it receives a Remote message. All Signal Generator settings remain unchanged when the transition from remote-to-local operation occurs.

The front-panel RMT annunciator turns off when the Signal Generator switches to local operation. However, the front-panel ADRS annunciator remains lit if the Signal Generator is still being addressed to listen (whether in remote or local operation).

The front-panel LOCAL key can also be used to return the Signal Generator to local operation. However, pressing the LOCAL key (when the Signal Generator is not in local lockout) might interrupt a Data message being sent to the Signal Generator. This would leave the Signal Generator in a state unknown to the controller. This situation is undesirable and can be avoided by sending the Local Lockout message to disable the LOCAL key.

Receiving the Local Lockout Message

The Local Lockout message is the means by which the controller sends the Local Lockout (LLO) bus command. If the Signal Generator is in remote operation, it responds to the Local Lockout message by disabling the front-panel LOCAL key. Local lockout prevents the loss of data or system control due to someone accidentally pressing any of the front-panel keys. If the Signal Generator is in local operation when it is enabled to remote operation (that is, REN is set true) and it receives the Local Lockout message, it switches to remote with local lockout operation the first time it is addressed to listen. Once in local lockout, the Signal Generator can only be returned to local operation by the controller or by unplugging or switching the Signal Generator to STBY and then back to ON.

Receiving the Clear Lockout/Set Local Message

The Clear Lockout/Set Local message is the means by which the controller sets the Remote Enable bus control line (REN) false. The Signal Generator returns to local operation (full front-panel control) when it receives the Clear Lockout/Set Local message. All Signal Generator settings remain unchanged when the transition from remote with lockout to local operation occurs.

The front-panel RMT annunciator is turned off when the Signal Generator switches to local operation.

Receiving the Pass Control Message

The Signal Generator does not respond to the Pass Control message because it cannot act as a controller.

Sending the Require Service Message

The Signal Generator does not have the capability to require service by setting the Service Request bus control line (SRQ) true.

Sending the Status Byte Message

The Signal Generator does not have the capability to respond to a Serial Poll Enable (SPE) bus command; therefore, it cannot send the Status Byte message.

Sending the Status Bit Message

The Signal Generator does not have the capability to respond to a Parallel Poll Enable (PPE) bus command; therefore, it cannot send the Status Bit message.

Receiving the Abort Message

The Abort message is the means by which the controller sets the Interface Clear bus control line (IFC) true. When the Abort message is received, the Signal Generator becomes unaddressed and stops listening.

Table 3—4. HP-IB Program Codes (Alphabetical Order)

Program Code ¹	Parameter	Comments
AM	Amplitude Modulation	Function Entry
AO	Amplitude Offset	Function Entry
AP	Amplitude (carrier)	Function Entry
DB	dB	Units Entry
DF	dBf	Units Entry
DM	dBm	Units Entry
DN	Step Down (↓)	Function Feature
EM	EMF	Units Entry
FM	Frequency Modulation	Function Entry
FR	Frequency (carrier)	Function Entry
GT	Flexible Sequence	Feature
HI	HI ALC ²	Function Feature
HZ	Hz	Units Entry
IS	Increment Set	Function Qualifier
KZ	kHz	Units Entry
LO	LO ALC ²	Function Feature
MV	mV	Units Entry
MZ	MHz	Units Entry

¹ Program codes can be either upper or lower case.
² Not available on the HP 8656B.

Table 3-4. HP-IB Program Codes (Alphabetical Order Cont'd)

Program Code ¹	Parameter	Comments
PC	Percent ³	Units Entry
PD	Phase Decrement	Function Feature
PF	Pulse Modulation (Fast Mode) ⁵	Function Entry
PI	Phase Increment	Function Feature
PM	Pulse Modulation ⁵	Function Entry
QS	Reverse Sequence	Feature
RC	Recall (0-9)	Feature
RL	Recall (0-99)	Feature
RP	Reverse Power Protection Reset ⁴	Feature
R0	Standby	Feature
R1	On	Feature
R2	RF OFF	Function Feature
R3	RF ON	Function Feature
R5	RF DEAD ⁶	Function Feature
SQ	Sequence	Feature
ST	Save (0-9)	Feature
SV	Save (0-99)	Feature
S1	External Modulation Source	Source Qualifier
S2	Internal 400 Hz Modulation Source	Source Qualifier
S3	Internal 1 kHz Modulation Source	Source Qualifier
S4	Modulation Source Off	Source Qualifier
S5	DC FM	Function Entry
UP	Step Up (\uparrow)	Function Feature
UV	μ V	Units Entry
VL	Volts	Units Entry
0-9	Numerals 0-9	Data Entries
-	Minus Sign	Data Entry
.	Decimal Point	Data Entry
%	Percent ²	Units Entry

¹ Program codes can be either upper or lower case.
³ Either PC or % can be used.
⁴ The source of reverse power must be removed.
⁵ You can select 2 modes for Pulse Modulation.
⁶ Switches in all attenuator pads for reduced spurs (HP 8657B only).

Table 3-5. HP-IB Program Codes (Functional Order)

Parameter	Program Code ¹	Parameter	Program Code ¹
Frequency		Units (Cont'd)	
Frequency (carrier)	FR	mV	MV
		μV	UV
Amplitude		Hz	HZ
Amplitude (carrier)	AP	kHz	KZ
Amplitude Offset	AO	MHz	MZ
		Percent ³	PC
		Percent ³	%
Modulation			
Amplitude Modulation	AM	Other	
Frequency Modulation	FM	HI ALC ²	HI
External Modulation Source	S1	LO ALC ²	LO
Internal 400 Hz Modulation Source	S2	Step Up (⬆)	UP
Internal 1 kHz Modulation Source	S3	Step Down (⬇)	DN
Modulation Source Off	S4	Increment Set	IS
DC FM	S5	Phase Increment	PI
Pulse Modulation	PM ⁵	Phase Decrement	PD
Pulse Modulation (Fast Mode)	PF ⁵	Standby	R0
		On	R1
Data		RF OFF	R2
Numerals 0-9	0-9	RF ON	R3
Minus Sign	-	RF DEAD ⁶	R5
Decimal Point	.	Save (0-9)	ST
		Recall (0-9)	RC
Units		Save (0-99)	SV
dB	DB	Recall (0-99)	RL
dBf	DF	Sequence	SEQ
dBm	DM	Flexible Sequence	GT
EMF	EM	Reverse Sequence	QS
Volts	VL	Reverse Power Protection Reset ⁴	RP

¹ Program codes can be either upper or lower case.

² Not available on the HP 8656B.

³ Either PC or % can be used.

⁴ The source of reverse power must be removed.

⁵ There are two modes you can select for Pulse Modulation.

⁶ This function switches in all attenuator pads for reduced spurs (HP 8657B only).

NOTE

Pulse Modulation is available as an option on the HP 8657B only.

Table 3-6. Commonly Used Code Conversions

ASCII	Binary	Octal	Decimal	Hexadecimal	ASCII	Binary	Octal	Decimal	Hexadecimal
NUL	00 000 000	000	0	00	@	01 000 000	100	64	40
SOH	00 000 001	001	1	01	A	01 000 001	101	65	41
STX	00 000 010	002	2	02	B	01 000 010	102	66	42
ETX	00 000 011	003	3	03	C	01 000 011	103	67	43
EOT	00 000 100	004	4	04	D	01 000 100	104	68	44
ENQ	00 000 101	005	5	05	E	01 000 101	105	69	45
ACK	00 000 110	006	6	06	F	01 000 110	106	70	46
BEL	00 000 111	007	7	07	G	01 000 111	107	71	47
BS	00 001 000	010	8	08	H	01 001 000	110	72	48
HT	00 001 001	011	9	09	I	01 001 001	111	73	49
LF	00 001 010	012	10	0A	J	01 001 010	112	74	4A
VT	00 001 011	013	11	0B	K	01 001 011	113	75	4B
FF	00 001 100	014	12	0C	L	01 001 100	114	76	4C
CR	00 001 101	015	13	0D	M	01 001 101	115	77	4D
SO	00 001 110	016	14	0E	N	01 001 110	116	78	4E
SI	00 001 111	017	15	0F	O	01 001 111	117	79	4F
DLE	00 010 000	020	16	10	P	01 010 000	120	80	50
DC1	00 010 001	021	17	11	Q	01 010 001	121	81	51
DC2	00 010 010	022	18	12	R	01 010 010	122	82	52
DC3	00 010 011	023	19	13	S	01 010 011	123	83	53
DC4	00 010 100	024	20	14	T	01 010 100	124	84	54
NAK	00 010 101	025	21	15	U	01 010 101	125	85	55
SYN	00 010 110	026	22	16	V	01 010 110	126	86	56
ETB	00 010 111	027	23	17	W	01 010 111	127	87	57
CAN	00 011 000	030	24	18	X	01 011 000	130	88	58
EM	00 011 001	031	25	19	Y	01 011 001	131	89	59
SUB	00 011 010	032	26	1A	Z	01 011 010	132	90	5A
ESC	00 011 011	033	27	1B	[01 011 011	133	91	5B
FS	00 011 100	034	28	1C	\	01 011 100	134	92	5C
GS	00 011 101	035	29	1D]	01 011 101	135	93	5D
RS	00 011 110	036	30	1E	^	01 011 110	136	94	5E
US	00 011 111	037	31	1F	_	01 011 111	137	95	5F
SP	00 100 000	040	32	20	`	01 100 000	140	96	60
!	00 100 001	041	33	21	a	01 100 001	141	97	61
"	00 100 010	042	34	22	b	01 100 010	142	98	62
#	00 100 011	043	35	23	c	01 100 011	143	99	63
\$	00 100 100	044	36	24	d	01 100 100	144	100	64
%	00 100 101	045	37	25	e	01 100 101	145	101	65
&	00 100 110	046	38	26	f	01 100 110	146	102	66
'	00 100 111	047	39	27	g	01 100 111	147	103	67
(00 101 000	050	40	28	h	01 101 000	150	104	68
)	00 101 001	051	41	29	i	01 101 001	151	105	69
*	00 101 010	052	42	2A	j	01 101 010	152	106	6A
+	00 101 011	053	43	2B	k	01 101 011	153	107	6B
,	00 101 100	054	44	2C	l	01 101 100	154	108	6C
-	00 101 101	055	45	2D	m	01 101 101	155	109	6D
.	00 101 110	056	46	2E	n	01 101 110	156	110	6E
/	00 101 111	057	47	2F	o	01 101 111	157	111	6F
0	00 110 000	060	48	30	p	01 110 000	160	112	70
1	00 110 001	061	49	31	q	01 110 001	161	113	71
2	00 110 010	062	50	32	r	01 110 010	162	114	72
3	00 110 011	063	51	33	s	01 110 011	163	115	73
4	00 110 100	064	52	34	t	01 110 100	164	116	74
5	00 110 101	065	53	35	u	01 110 101	165	117	75
6	00 110 110	066	54	36	v	01 110 110	166	118	76
7	00 110 111	067	55	37	w	01 110 111	167	119	77
8	00 111 000	070	56	38	x	01 111 000	170	120	78
9	00 111 001	071	57	39	y	01 111 001	171	121	79
:	00 111 010	072	58	3A	z	01 111 010	172	122	7A
;	00 111 011	073	59	3B	{	01 111 011	173	123	7B
<	00 111 100	074	60	3C		01 111 100	174	124	7C
=	00 111 101	075	61	3D	~	01 111 101	175	125	7D
>	00 111 110	076	62	3E	DEL	01 111 110	176	126	7E
?	00 111 111	077	63	3F			177	127	7F

Table 3-7. HP-IB Message Reference Table

HP-IB Capability	Applicable	Response	Related Commands and Controls*	Interface Functions*
Data	Yes	All Front-Panel functions, except for DSPL, DSPL in conjunction with SEQ, display Amplitude Offset, Backspace, COARSE TUNE, FINE TUNE, and display HP-IB ADRS are programmable. The front panel ADRS annunciator lights when the Signal Generator is addressed to listen.		T0, L2, AH1, SH0
Trigger	No	The Signal Generator does not have a device trigger (DT0) capability.	GET	DT0
Clear	Yes	Resets the Signal Generator to a carrier frequency of 100 MHz, an output amplitude of -143.5 dBm, and no modulation. Responds equally to Device Clear (DCL) and Selected Device Clear (SDC) bus commands.	DCL, SDC	DC1
Remote	Yes	Remote operation is entered when the Remote Enable (REN) bus control line is true and the Signal Generator is first addressed to listen. The front-panel RMT and ADRS annunciators both light when remote operation is entered, all front-panel keys are disabled (except for the LOCAL key and the POWER switch), and the output signal remains unchanged.	REN	RL1
Local	Yes	The Signal Generator returns to local operation (full front-panel control) when either the Go to Local (GTL) bus command is received or the front-panel LOCAL key is pressed. The output signal remains unchanged.	GTL	RL1
Local Lockout	Yes	Disables the front-panel LOCAL key so that only the controller can return the Signal Generator to local operation.	LLO	RL1
Clear Lockout/Set Local	Yes	The Signal Generator returns to local operation and local lockout is cleared when the REN bus control line goes false.	REN	RL1
Pass Control/Take Control	No	The Signal Generator has no control capability.		C0
Require Service	No	The Signal Generator does not have the capability to request service.		SR0
Status Byte	No	The Signal Generator does not have the capability to respond to a serial poll.		T0
Status Bit	No	The Signal Generator does not have the capability to respond to a parallel poll enable.		PP0
Abort	Yes	The Signal Generator stops listening.	IFC	T0, L2
Driver Electronics	Yes	The Signal Generator has an open-collector, TTL, interface.		E1

* Commands, Control lines and Interface Functions are defined in IEEE Std 488 (and the identical ANSI Standard MC1.1). Knowledge of these might not be necessary if your controller's manual describes programming in terms of the twelve HP-IB Messages shown in the left column. Complete HP-IB capability as defined in IEEE Std 488 (and the identical ANSI Standard MC1.1) is: SH0, E1, AH1, T0, L2, SR0, RL1, PP0, DC1, DT0, and C0.

3-6. SWITCHING CHARACTERISTICS

The Signal Generator switching characteristics are an important consideration in applications involving a computer controller. If the timing requirements are not taken into account in the controller's program, it will be impossible in many situations to make meaningful measurements on a device driven by the Signal Generator.

Switching times for frequency, modulation, and amplitude have several characteristics in common. In each case a finite amount of time passes from the command (manual or computer generated) until the required output occurs. Software execution time is required for the microprocessor and related digital circuits to process the data. This begins with a valid final terminator (keystroke or data entry) and ends with the execution in the hardware. The software time may vary considerably depending on the function. Examples are internal instructions to more than one hardware location, (may be serial, parallel, or both) and differing amounts of control data and calculations.

Hardware execution time will also vary considerably. This depends on the number of circuits affected, the length of time each takes to change, and whether the changes occur one at a time or concurrently.

When the frequency of the HP 8656B is changed, RF is present at the output at all times during frequency switching.

When the frequency of the HP 8657A or HP 8657B is changed, the RF OUTPUT is turned off, then turned back on to ensure no power spikes. The RF OUTPUT off period is approximately 15 ms.

The 15 ms RF power drop-out can be disabled by selecting SHIFT then \uparrow (FM), that is, the up-arrow located below the FM button. This will leave the power output constant during frequency changes, that is, power transients are avoided by using a high bandwidth ALC (HI ALC) in the output section. Selecting SHIFT then \downarrow (FM), that is, the down-arrow located below the FM button, will return the HP 8657A or HP 8657B to normal operation (low bandwidth ALC (LO ALC), 15 ms RF drop out during frequency switching).

The HI ALC mode (no drop-out mode) is volatile and cannot be saved as part of a storage register, however, recalling a register or sequence will not change the current ALC mode. Power up condition is LO ALC.

Frequency Switching. The Signal Generator will typically be within 100 Hz of the final frequency and 1 dB of the required level within 25 ms after receiving the valid units data (terminator). Figure 3-2 shows the sequence of events and the typical error frequency relative to time. Area I shows the software execution time. Areas II through IV make up the hardware execution time.

At times certain events in the frequency switching cycle may be bypassed. For example, small frequency changes will often eliminate event II, the loop settling time or event III, the FM calibration cycle. However, the frequency change that allows these events to be bypassed depends on an involved algorithm that is a function of frequency. Therefore, it is best to assume that the entire sequence of events shown in Figure 3-2 occurs every time a frequency change is made.

To minimize the effects of variety in frequency switching times (especially near the frequency band edges), switch to the desired frequency from the same direction each time, that is, from either above or below the desired frequency. Ideally, the frequency change should be made from the same preset frequency.

During the FM calibration cycle caused by a frequency change, FM modulation is disabled (if it was enabled). This also applies to mixed modulation such as FM from two sources, or simultaneous AM and FM. After the frequency change and FM calibration is complete, FM modulation is turned back on.

Amplitude Switching. During an RF amplitude change, the final level is always approached from a lower level. This means that a critical amplitude level is never exceeded in the course of normal Signal Generator operation.

Software correction of amplitude with respect to frequency may cause the amplitude to be uncalibrated while a frequency change occurs.

The basic unit for amplitude in the Signal Generator is dBm. An input in other units requires calculations. This tends to increase the software execution time considerably. For example, an input in dBm generally will take about 30 ms from the terminator to the end of software execution. Examples of a change with calculations involved are:

- a preset level in mV with a change in dB, 30 ms
- a preset level and change in mV, 300 ms
- a preset level in dBm with a change in mV, 340 ms

A 10 dB change without modulation (narrowband Automatic Level Control-ALC) may take up to 50 ms in the vernier hardware circuits. With modulation (wideband ALC) the switching time is typically 40 ms. The step attenuator switching time is on the order of 12 ms.

Total time required for simple amplitude inputs or changes, that is, minimal software and hardware execution time is 40 to 50 ms. The most complex change may take up to 400 ms.

Modulation Switching. If the RF OUTPUT is modulated, depending on the type of modulation selected, the switching time may be increased. There are applications where it is necessary to turn modulation on or off, or to change to another modulation level. It takes about 400 ms for the modulation accuracy (AM or FM) to be within tolerance from the time the modulation (audio oscillator) is initially turned on. An FM deviation change typically occurs 60 ms after the final terminator (Units Key) triggers the change. Turning the FM off takes about 20 ms. Amplitude modulation normally takes about 120 ms to turn off or to change to a new depth.

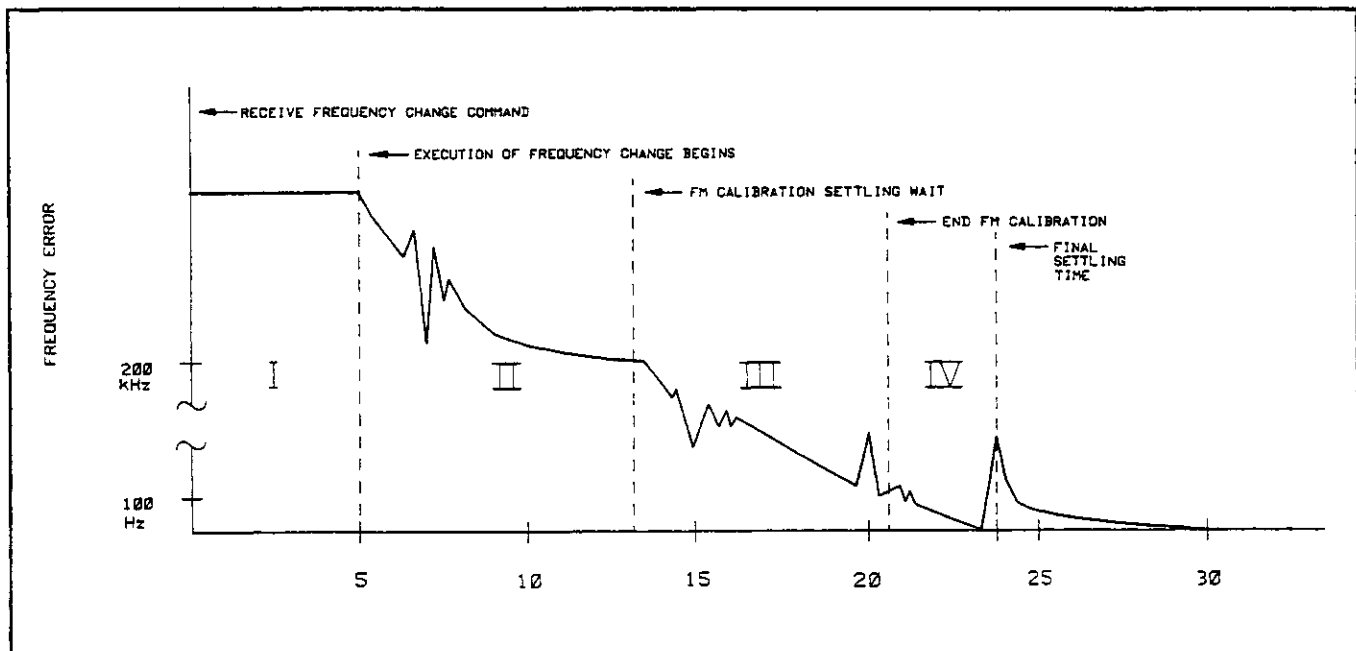

Figure 3-2. Frequency Switching Characteristics

3-7. SELECTING THE CORRECT PULSE MODULATION MODE

NOTE

Pulse Modulation is available as an option on the HP 8657B only.

If you want to use Pulse Modulation at a frequency ≥ 1030 MHz, then read the following information to help determine which mode of Pulse Modulation you should select for your application.

You can select two modes of Pulse Modulation:

- Pulse Modulation.
- Pulse Modulation (Fast Mode).

For both modes, if the carrier frequency is ≥ 1030 MHz, when Pulse Modulation is selected, or the carrier frequency or amplitude is changed with Pulse Modulation selected, then the HP 8657B performs an internal calibration.

The calibration routine turns Pulse Modulation off, switches the RF output on and then calibrates the RF output level. When the calibration is complete, the RF output is switched off, and Pulse Modulation is switched back on.

The implementation of this calibration is different for each mode of Pulse Modulation.

Pulse Modulation Calibration. During the calibration routine, the HP 8657B's attenuator is switched in to prevent the calibration signal from appearing at the RF OUTPUT. This means that in high cycle applications, where the frequency or amplitude of the HP 8657B is constantly modified, then the life of the attenuator may be reduced.

Pulse Modulation (Fast Mode) Calibration. During the calibration routine, the calibration signal or pulse will appear at the RF OUTPUT. The pulse duration is approximately 15 ms at the same level as the CW level. This might present a problem if the Device Under Test is only designed to accept pulses in the μs range.

CAUTION

The HP 8657B performs a calibration on the output level when Pulse Modulation (Fast Mode) is first selected, or when the Amplitude or Frequency is modified with Pulse Modulation (Fast Mode) selected.

During this calibration, a calibration pulse appears at the RF OUTPUT for approximately 15 ms at the same level as the CW level.

Check the specifications of any equipment which the HP 8657B is being used to test, to ensure that the calibration pulse will not cause any damage.

Impedance Mismatching

Impedance mismatch is an important consideration in deciding which mode of Pulse Modulation to select for applications using a frequency ≥ 1030 MHz.

Pulse Modulation (Fast Mode) calibrates directly into your load. Therefore, the level difference between CW RF and pulsed RF will be typically $< \pm 0.1$ dB.

Pulse Modulation calibrates into the attenuator. This means that any mismatch between your load, and the attenuator impedance of 50 ohms, will cause a level difference between CW RF and pulsed RF. Typically, for a 50 ohm load, the error will be $< \pm 0.25$ dB.

NOTE

This error will only be significant for RF levels > +3.9 dBm. Below this level the HP 8657B's attenuator minimizes the effect of any mismatch.

Summary

Use Pulse Modulation for:

- a. General purpose bench use.
- b. To test sensitive loads.

Use Pulse Modulation (Fast Mode) for:

- a. Non 50 ohm loads.
- b. When you require best level accuracy.
- c. In ATE applications where attenuator lifespan needs to be maximised.

3-9. DETAILED OPERATING INSTRUCTIONS

The information contained in this section is presented as follows:

Title: Lists the main feature or function to be discussed.

Description: Describes the feature or function.

Keystroke Sequence: Provides information to allow you to use the feature or function.

Example: Describes the necessary steps required to accomplish one or more of the features or functions discussed in the "Keystroke Sequence."

Keys and Program Codes: Lists a table with the associated keys and HP-IB program codes for controller execution of that feature or function.

Indications: Describes the response of the Signal Generator when the keystroke sequence is performed; which annunciators will light, and which displays are used.

Comments: Describes any miscellaneous information or information to clarify the feature or function capabilities.

Related Instructions: Lists other features or functions which are related.

NOTE

Pulse Modulation is available as an option on the HP 8657B only.

Table 3-8. Index of Detailed Operating Instructions

Instruction	Page	Instruction	Page
Frequency	3-28	Increment Value Change	3-37
Frequency, Coarse and Fine Tune	3-30	Increment Value Display	3-39
Frequency, Phase Up/Down	3-32	Display	3-26
Frequency, Up/Down	3-33	Display Amplitude Offset	3-25
Amplitude	3-18	Display Sequence	3-27
Amplitude Conversion	3-20	Instrument Preset	3-41
Amplitude Offset	3-22	Recall	3-66
Amplitude, Up/Down	3-23	RF OFF/ON	3-67
Modulation, AM	3-42	Sequence	3-69
Modulation, AM Up/Down	3-44	Save	3-68
Modulation, DC FM	3-46	HP-IB Address Display	3-36
Modulation, DC FM Up/Down	3-48		
Modulation, External Source	3-50		
Modulation, FM	3-51		
Modulation, FM Up/Down	3-53		
Modulation, Mixed	3-55		
Modulation, Off	3-60		
Modulation, Pulse	3-62		
Modulation, Pulse (Fast Mode)	3-64		

The detailed operating instructions are arranged in alphabetical order starting on the next page.

Amplitude

Description

This instruction details how to set the output amplitude.

Keystroke Sequence

Press the AMPTD Function key, the desired Data keys, and a valid Units key or combination of valid Units keys.

Examples

Set the output amplitude to -12.3 dBm .

	FUNCTION	DATA	UNITS
LOCAL (keys)	AMPTD	- 1 2 . 3	dBm
HP-IB (program codes)	AP -12.3 DM		

Set the output amplitude to $-2.0 \text{ dB EMF } \mu\text{V}$.

	FUNCTION	DATA	UNITS
LOCAL (keys)	AMPTD	- 2 . 0	dB EMF μV
HP-IB (program codes)	AP -2.0 DB EM UV		

Keys and Program Codes

Keys	Codes
AMPTD	AP
dBm	DM
dBf	DF
dB	DB
EMF	EM
V	VL
mV	MV
μV	UV

Indications

The selected output amplitude (with sign and units) will be displayed in the AMPLITUDE Display.

Comments

Digits selected beyond the specified resolution of the AMPLITUDE Display are truncated.

Leading zeros are blanked.

Calibrated level for the **HP 8656B** is from -124 dBm to +7.0 dBm with underrange to -127 dBm and overrange to +17 dBm.

Calibrated level for the **HP 8657A** is from -127 dBm to +7.0 dBm with underrange to -143.5 dBm and overrange to +17 dBm.

Calibrated level for the **HP 8657B** is from -127 dBm to +3.5 dBm with underrange to -143.5 dBm and overrange to +17 dBm.

Minus sign may be entered at any time before the final terminator.

Amplitude Data entries that would cause the peak envelope power of the Signal Generator to exceed +17 dBm are rejected.

Amplitude function remains selected until:

- a. One of the three remaining functions is selected (AM, FM, or FREQUENCY).
- b. One of the SAVE, RECALL, SEQUENCE keys or Display (SHIFT, DSPL) is pressed.
- c. The Signal Generator is preset, unplugged, or switched to standby.

Fourteen valid units entries are possible which will cause one or more AMPLITUDE annunciators to light. They are as follows:

dBm	dB μ V	V	EMF mV
dBf	dB EMF V	mV	EMF μ V
dBV	dB EMF mV	μ V	
dBmV	dB EMF μ V	EMF V	

Whenever a reverse power condition is detected, all segments and all LED annunciators associated with the AMPLITUDE Display flash until the source of reverse power is removed and the AMPTD key is pressed.

Related Instructions

Amplitude Conversion
Amplitude, Up/Down

Amplitude Conversion

Description



This instruction details how to change the AMPLITUDE Display from power units in dBm to any one of 13 other valid unit configurations. This feature does not affect the actual output amplitude of the Signal Generator.

Keystroke Sequence

Press any valid Units key or combination of valid Units keys with the amplitude function selected.

Example

The AMPLITUDE display shows 10.0 dBm. Change the display to units of dB μ V. (The resulting display will be 117.0 dB μ V.)

	PREFIX TERMINATOR	FINAL TERMINATOR
LOCAL (keys)		
 (program codes)	DB UV	

Keys and Program Codes

Keys	Codes
dBm ¹	DM ¹
dBf ¹	DF ¹
dB ^{2,3}	DB ^{2,3}
EMF ²	EM ²
V ¹	VL ¹
mV ¹	MV ¹
μ V ¹	UV ¹
¹ Final Terminator. ² Prefix Terminator. ³ Final Terminator for increment Set.	

Indications

The AMPLITUDE Display changes to reflect the newly selected units, and the corresponding annunciator(s) will light.

Comments

The Amplitude function must be selected before the conversion entry or entries are made.

Logarithmic Data entries (dBm or dBf) will be displayed in the AMPLITUDE Display with 0.1 dB resolution.

The dBm or dBf Units terminator overrides a dB or EMF terminator.

If a dB or EMF Units terminator is selected, the AMPLITUDE Display is blanked, the corresponding annunciator lights, and the Signal Generator waits for a final terminator to be entered.

Linear Data entries (V, mV, or μ V) are displayed in the three most significant digits of the AMPLITUDE Display, and the linear terminator is autoranged (or adjusted) to comply with this condition.

Conversion formulas used are as follows:

$$\begin{aligned}
 dB &= dBm \\
 dBf &= dBm + 120.0 \\
 dBV &= dBm - 13.0 \\
 dBmV &= dBm + 47.0 \\
 dB \mu V &= dBm + 107.0 \\
 dB \text{ EMF } V &= dBm - 7.0 \\
 dB \text{ EMF } mV &= dBm + 53.0 \\
 dB \text{ EMF } \mu V &= dBm + 113.0 \\
 V &= 10^{(dBm-13.0)/20} \\
 mV &= 10^{(dBm+47.0)/20} \\
 \mu V &= 10^{(dBm+107.0)/20} \\
 \text{EMF } V &= 10^{(dBm-7.0)/20} \\
 \text{EMF } mV &= 10^{(dBm+53.0)/20} \\
 \text{EMF } \mu V &= 10^{(dBm+113.0)/20}
 \end{aligned}$$

Related Instructions

Amplitude
Amplitude, Up/Down

Amplitude Offset

Description

This instruction details how to use the Amplitude Offset feature. This feature can be used to compensate the output amplitude for gains or losses in a test system due to cables, mixers, etc.

Keystroke Sequence

Press the SHIFT key, the AMPTD key, then use the Data keys to select the offset you want. Enter the offset by pressing the dB key.

Keys and Program Codes

Keys	Codes
AMPTD dB	AO DB

Indications

The RF OUTPUT amplitude is increased or decreased by the value of the offset, and the OFFSET annunciator lights. The displayed amplitude does not change.

Comments

To check the value of offset, press the SHIFT key then press and hold the AP OFS key.

To reset the output amplitude to the displayed value, enter an offset of 0 dB. The Amplitude Offset initializes to 0 dB when the Signal Generator is PRESET.

A change in RF OUTPUT amplitude that would make the sum of the amplitude and offset to be above or below the operating limits of the Signal Generator, will cause the Signal Generator to output only a maximum or minimum output limit.

Performing this feature clears any previously selected function.

Related Instructions

Display Amplitude Offset

Amplitude, Up/Down

Description

This instruction details how to change the output amplitude by the stored value of amplitude increment.

Keystroke Sequence

Press the AMPTD \uparrow or AMPTD \downarrow key.

Keys and Program Codes

Keys	Codes
AMPTD \uparrow \downarrow	AP UP DN

NOTE

During remote operation, repeated UP or DN codes can be sent over the bus once the amplitude function is selected.

Indications

The output amplitude changes by the stored value of amplitude increment.

Comments

Keeping either key pressed continues to change the output amplitude.

If the output amplitude increment is set to a value that would cause the Signal Generator to exceed its amplitude range (+17 dBm to -143.5 dBm for the HP 8657A, HP 8657B and +17 dBm to -127 dBm for the HP 8656B), the AMPTD \uparrow or AMPTD \downarrow key becomes inoperative (this is determined by which amplitude limit would be exceeded). A correct decrease in the increment setting re-enables the AMPTD \uparrow or AMPTD \downarrow key.

Performing this feature places the Signal Generator in the Amplitude Data entry mode, and clears any previously selected function.

Increment entries are checked against maximum and minimum allowable increment limits. If a limit is exceeded, the increment entry is either truncated or rejected.

Initialized value and limits of the output amplitude increment are as follows:

Model	Initialized Value	Minimum Value	Maximum Value
HP 8656B	1 kHz	0.1 dB	\leq 144.0 dB
HP 8657A	1 kHz	0.1 dB	\leq 160.5 dB
HP 8657B	1 kHz	0.1 dB	\leq 160.5 dB

Related Instructions

Amplitude
Amplitude Conversion
Increment Value Change
Increment Value Display

Display Amplitude Offset

DESCRIPTION

This instruction details how to display the value of the Amplitude Offset.

Keystroke Sequence

Press the SHIFT key, then press and hold the AMPTD key.

Indications

The Amplitude Offset value is shown in the AMPLITUDE display as long as the AMPTD key remains pressed.

Comments

The Amplitude Offset initializes to a value of 0 dB when the Signal Generator is preset.

If RF ON/OFF is switched to OFF, you can still check the value of Amplitude Offset.

Performing this feature:

- Clears any previously selected function.
- Does not affect the original AMPLITUDE display setting.
- Keeps the Signal Generator in the Amplitude Offset mode until another function key is pressed.

Related Instructions

Amplitude Offset
Display
Display Sequence
HP-IB Address Display
Increment Value Display

Display

Description

This instruction details how to review a saved front-panel set-up.

Keystroke Sequence

Press the SHIFT key then press the DSPL key. Use the Data keys to select the set-up you want to review (press and hold the second Data key).

Example

Review the front-panel set-up saved in memory location 02.

LOCAL (keys)	SHIFT	DSPL SEQ	0	2
 (program codes)	This feature is not accessible via HP-IB.			

Indications

The selected set-up is displayed as long as the last Data key remains pressed and will remain for 1 second after the second Data key is released.

Comments

You can save up to 100 (0-99) front-panel set-ups (exclusive of increment settings).

Performing this feature:

- Does not affect the current set-up of the Signal Generator.
- Does not change the position of the sequence counter.
- Clears any previously selected function.

All displays are restored to the current Signal Generator set-up when the Data key is released.

Related Instructions

- Display Amplitude Offset
- Display Sequence
- Recall
- Sequence
- Store

Display Sequence

Description

This instruction details how to display the current position of the sequence counter.

Keystroke Sequence

Press the SHIFT key, press DSPL, and then press and hold the SEQ key.

Indications

The amplitude and modulation displays will blank and the frequency display will appear as XX....YY. XX is the current active register and YY is the next register the Signal Generator will jump to when the SEQUENCE key is pressed. This display will remain for 1 second, or for as long as the SEQUENCE key is held, whichever is the longer.

Comments

Performing this feature:

- Clears any previously selected function.
- Does not affect the actual output of the Signal Generator.

The AMPLITUDE Display is restored to reflect the actual Signal Generator output when the SEQ key is released.

Related Instructions

Display
Display Amplitude Offset
Sequence

Frequency

Description

This instruction details how to set the carrier frequency.

Keystroke Sequence

Press the FREQUENCY Function key, the desired Data keys, and a valid Units key.

Example

Set the carrier frequency to 123.45 MHz.

LOCAL (keys)	FUNCTION	DATA	UNITS
	FREQ	1 2 3 . 4 5	MHz
HP IB (program codes)	FR 123.45 MZ		

Keys and Program Codes

Keys	Codes
FREQ	FR
MHz	MZ
kHz	KZ
No key	HZ

Indications

The selected carrier frequency is displayed in megahertz in the FREQUENCY Display.

Comments

Digits selected beyond the specified resolution of the FREQUENCY Display are truncated.

Leading zeros are blanked.

Carrier frequencies below 100 kHz will result in an uncalibrated output amplitude.

If you select a carrier frequency that makes the currently selected FM Peak Deviation outside the Signal Generator operating limits, then the MODULATION Display flashes. To clear this error condition enter a new carrier frequency in the correct band for the selected Peak Deviation. To automatically select the maximum permitted Peak Deviation for the carrier frequency, press the FM, FM↑ or FM↓ key.

HP 8656B Carrier Frequency (MHz)	Maximum Peak Deviation	
	AC Mode	DC Mode
	(the lesser of)	
0.1 to 123.5	99 kHz or 4000 × rate (Hz)	99 kHz
123.5 to 247	50 kHz or 1000 × rate (Hz)	50 kHz
247 to 494	99 kHz or 2000 × rate (Hz)	99 kHz
494 to 990	99 kHz or 4000 × rate (Hz)	99 kHz

HP 8657A Carrier Frequency (MHz)	Maximum Peak Deviation	
	AC Mode	DC Mode
	(the lesser of)	
0.1 to 130	99 kHz or 4000 × rate (Hz)	99 kHz
130 to 260	50 kHz or 1000 × rate (Hz)	50 kHz
260 to 520	99 kHz or 2000 × rate (Hz)	99 kHz
520 to 1040	99 kHz or 4000 × rate (Hz)	99 kHz

HP 8657B Carrier Frequency (MHz)	Maximum Peak Deviation	
	AC Mode	DC Mode
	(the lesser of)	
0.1 to 130	200 kHz or 4000 × rate (Hz)	200 kHz
130 to 260	50 kHz or 1000 × rate (Hz)	50 kHz
260 to 520	100 kHz or 2000 × rate (Hz)	100 kHz
520 to 1040	200 kHz or 4000 × rate (Hz)	200 kHz
1040 to 2060	400 kHz or 8000 × rate (Hz)	400 kHz

The Frequency function remains selected until:

- a. One of the three remaining functions is selected (AM, FM, or AMPTD).
- b. One of the SAVE, RECALL, SEQUENCE keys or Display (SHIFT, DSPL) is pressed.
- c. The Signal Generator is preset, unplugged, or switched to standby.

Related Instructions

Frequency, Coarse and Fine Tune
 Frequency, Up/Down

Frequency, Coarse and Fine Tune

Description

This instruction details how to quickly tune the carrier frequency in decade steps using the step-up and step-down keys associated with the carrier frequency function.

Keystroke Sequence

This feature is enabled by pressing either the COARSE TUNE or FINE TUNE key.





Pressing either key will increase (COARSE TUNE) or decrease (FINE TUNE) the carrier frequency tuning value by a factor of 10.

Pressing the step-up key increases the carrier frequency by the newly selected carrier frequency tuning value, while pressing the step-down key decreases the carrier frequency.

This feature is disabled and the original carrier frequency increment value is enabled by pressing the INCR SET key (with the frequency function selected).

Example

Enable a carrier frequency tuning value of 10 kHz (assuming a starting value of 10 MHz).

LOCAL (keys)			
 (program codes)	This feature is not accessible via HP-IB.		

Indications

Whenever the COARSE TUNE or FINE TUNE key is pressed and held, the frequency digit that corresponds to the carrier frequency tuning value will flash.

When the COARSE TUNE key is pressed again, the next digit to the left will flash to indicate the new tuning value.

When the FINE TUNE key is pressed again, the next digit to the right will flash to indicate the new tuning value.

Comments

This feature only applies to the carrier frequency function.

COARSE TUNE and FINE TUNE keys are always available to change the carrier frequency tuning value by a factor of 10.

Performing this feature:

- Places the Signal Generator into the frequency Data entry mode, and clears any previously selected function, once either the step-up or step-down key is pressed.
- Enables the last valid carrier frequency increment value when the INCR SET key is pressed.

Related Instructions

Frequency

Frequency, Up/Down

Increment Value Change

Frequency, Phase Up/Down

Description

This instruction details how to change the carrier frequency phase in one-degree increments or decrements with respect to the internal or external timebase.

Keystroke Sequence

Press the SHIFT key, then press the step-up or step-down keys associated with the carrier frequency function.

Keys and Program Codes

Keys	Codes
$\Phi \uparrow$	PI
$\Phi \downarrow$	PD

NOTE

During remote operation, repeated PI or PD codes can be sent over the bus.

Indications

The carrier frequency phase changes in 1 degree steps each time the keystroke sequence is followed.

Comments

The carrier frequency phase continues to increment or decrement in 1 degree steps, if either key remains pressed.

Selecting this feature does not affect any previously selected function.

Frequency, Up/Down

Description

This instruction details how to change the carrier frequency by the stored value of frequency increment.

Keystroke Sequence

Press the **FREQ↑** or **FREQ↓** key.

Keys and Program Codes

Keys	Codes
FREQ ↑ ↓	FR UP DN

NOTE

During remote operation, repeated UP or DN codes can be sent over the bus once the frequency function is selected.

Indications

The carrier frequency changes by the stored value of frequency increment.

Comments

Performing this feature:

- Places the Signal Generator in the Frequency Data entry mode, and clears any previously selected function.
- Continues to change the carrier frequency by the stored value of frequency increment if either key remains pressed.

Increment entries are checked against maximum and minimum allowable increment limits. If a limit is exceeded, the increment entry is either truncated or rejected.

If the carrier frequency increment is set to a value that would cause the Signal Generator to exceed its frequency range, then either the **FREQ↑** or **FREQ↓** key is made inactive (determined by which frequency limit would be exceeded). Decreasing the frequency increment reactivates the key.

If you select a carrier frequency that makes the currently selected FM Peak Deviation outside the Signal Generator's operating limits, then the MODULATION Display flashes. To clear this error condition enter a new carrier frequency in the correct band for the selected Peak Deviation. To automatically select the maximum permitted Peak Deviation for the carrier frequency, press the FM, FM↑ or FM↓ key.

HP 8656B Carrier Frequency (MHz)	Maximum Peak Deviation	
	AC Mode	DC Mode
	(the lesser of)	
0.1 to 123.5	99 kHz or 4000 × rate (Hz)	99 kHz
123.5 to 247	50 kHz or 1000 × rate (Hz)	50 kHz
247 to 494	99 kHz or 2000 × rate (Hz)	99 kHz
494 to 990	99 kHz or 4000 × rate (Hz)	99 kHz

HP 8657A Carrier Frequency (MHz)	Maximum Peak Deviation	
	AC Mode	DC Mode
	(the lesser of)	
0.1 to 130	99 kHz or 4000 × rate (Hz)	99 kHz
130 to 260	50 kHz or 1000 × rate (Hz)	50 kHz
260 to 520	99 kHz or 2000 × rate (Hz)	99 kHz
520 to 1040	99 kHz or 4000 × rate (Hz)	99 kHz

HP 8657B Carrier Frequency (MHz)	Maximum Peak Deviation	
	AC Mode	DC Mode
	(the lesser of)	
0.1 to 130	200 kHz or 4000 × rate (Hz)	200 kHz
130 to 260	50 kHz or 1000 × rate (Hz)	50 kHz
260 to 520	100 kHz or 2000 × rate (Hz)	100 kHz
520 to 1040	200 kHz or 4000 × rate (Hz)	200 kHz
1040 to 2060	400 kHz or 8000 × rate (Hz)	400 kHz

Initialized value and limits of the carrier frequency increment are as follows:

Model	Initialized Value	Minimum Value	Maximum Value
HP 8656B	1 kHz	0.01 kHz	≤ 989.999999 kHz
HP 8657A	1 kHz	0.01 kHz	≤ 999.999999 kHz
HP 8657B	1 kHz	0.001 kHz	≤ 999.999999 kHz

Related Instructions

Frequency

Frequency, Coarse and Fine Tune

Increment Value Change

Increment Value Display

HP-IB Address Display

Description

This details how to display the Signal Generator's decimal HP-IB address.

Keystroke Sequence

Press the SHIFT key, then press and hold ADRS.

Indications

The internally set, decimal HP-IB address is displayed in the MODULATION Display as long as ADRS remains pressed.

Comments

The HP-IB address is factory-set to 07 decimal. (In binary, this is 00111, the equivalent ASCII character is an apostrophe).

The HP-IB address is updated only when the Signal Generator is powered up.

To change the HP-IB address, refer to HP-IB Address Selection in Section 2.

The MODULATION Display is restored to reflect the actual output when ADRS is released.

Related Instructions

Display Amplitude Offset

Increment Value Change

Description

This instruction details how to change the stored value of increments which are controlled by the step-up and step-down keys associated with each of the four main functions. Increment values for the carrier frequency, output amplitude, AM depth, and FM peak deviation can be stored. The initialized value of each stored increment for the Signal Generator is listed below:

Functions	Initialized Value
Carrier Frequency	10 MHz
Output Amplitude	10 dB
AM Depth	1%
FM Peak Deviation	1.0 kHz

Keystroke Sequence

Press a Function key, the INCR SET key, the desired Data keys, and a valid Units Key.

Example

Set a carrier frequency increment of 1 MHz.

	FUNCTION	INCREMENT SET	DATA	UNITS
LOCAL (keys)	FREQ	INCR SET	1	MHz
↔ HP-IB ↔ (program codes)	FR IS 1 MZ			

Keys and Program Codes

Keys	Codes	Keys	Codes
INCR SET	IS	%	% or PC
FREQ	FR	dBm	DM
AMPTD	AP	dB	DF
AM	AM	dB	DB

Indications

The value of the increment appears in the display associated with the selected function as the data is entered.

Comments

FM peak deviation increments are selected in units of kHz only. AM depth is selected without fractional digits. All fractional digits are truncated.

If the increment value change is set to a value that would cause the Signal Generator to exceed a minimum or maximum range, the step-up and step-down key associated with that function become inoperative. A correct decrease in the increment setting re-enables the step-up and step-down keys.

Increment entries are checked against maximum and minimum allowable increment limits. If a limit is exceeded the increment entry is either truncated or rejected.

Minimum and maximum allowable increment values for each of the four main functions are listed below.

	Function	Minimum Value	Maximum Value
HP 8656B	Carrier Frequency	0.01 kHz	≤ 989.999999 MHz
	Output Amplitude	0.1 dB	≤ 144.0 dB
		0.001 μV	≤ 1.57 V
		0.001 EMF μV	≤ 3.15 EMF V
	AM Depth	1%	≤ 99%
	FM Peak Deviation	0.1 kHz	≤ 99 kHz

	Function	Minimum Value	Maximum Value
HP 8657A	Carrier Frequency	0.01 kHz	≤ 999.999999 MHz
	Output Amplitude	0.1 dB	≤ 160.5 dB
		0.001 μV	≤ 1.57 V
		0.001 EMF μV	≤ 3.15 EMF V
	AM Depth	1%	≤ 99%
	FM Peak Deviation	0.1 kHz	≤ 99 kHz

	Function	Minimum Value	Maximum Value
HP 8657B	Carrier Frequency	0.001 kHz	≤ 999.999999 MHz
	Output Amplitude	0.1 dB	≤ 160.5 dB
		0.001 μV	≤ 1.57 V
		0.001 EMF μV	≤ 3.15 EMF V
	AM Depth	1%	≤ 100%
	FM Peak Deviation	0.1 kHz	≤ 200 kHz

All displays are restored to reflect the actual Signal Generator output as soon as a valid increment terminator is selected.

Related Instructions

- Amplitude, Up/Down
- Frequency, Coarse and Fine Tune
- Frequency, Up/Down
- Increment Value Display Modulation, AM Up/Down
- Modulation, DC FM
- Modulation, FM Up/Down

Increment Value Display

Description



This instruction details how to display the stored value of the increments which are controlled by the step-up and step-down keys associated with each of the four main functions. Increment values for the carrier frequency, output amplitude, AM depth, and FM peak deviation can be displayed.

Keystroke Sequence

Press a function key, then press and hold the INCR SET key.

Example

Display the stored carrier frequency increment.

	FUNCTION	INCREMENT SET
LOCAL (keys)		
 (program codes)	FR IS	

Keys and Program Codes

Keys	Codes
AM	AM
FM	FM
INCR SET	IS
FREQ	FR
AMPTD	AP

Indications

The stored value of the increment is displayed in the display associated with the selected function as long as the INCR SET key remains pressed.

Comments

The initialized value of each stored increment is listed as follows:

Functions	Initialized Value
Carrier Frequency	10 MHz
Output Amplitude	10 dB
AM Depth	1%
FM Peak Deviation	1.0 kHz

The display is restored to reflect the actual Signal Generator output when the INCR SET key is released.

Related Instructions

Amplitude Up/Down
Display Amplitude Offset
Frequency, Up/Down
Increment Value Change
Modulation, AM Up/Down
Modulation, DC FM
Modulation, FM Up/Down

Instrument Preset

Description

This instruction details how to preset the Signal Generator.

Keystroke Sequence

Press the SHIFT key, and then the 0 units key.

NOTE

Sending the Clear message via HP-IB is equivalent to performing an instrument preset.

Indications

When a preset is performed, the Signal Generator resets to the following:

Carrier Frequency and Amplitude:

- 100 MHz, -127.0 dBm for the HP 8656B.
- 100 MHz, -143.5 dBm for the HP 8657A and HP 8657B.
Carrier Frequency Increment: 10 MHz
Output Amplitude Increment: 10 dB
Output Amplitude Offset: 0 dB
AM Depth: 0%
AM Depth Increment: 1%
FM Peak Deviation: 0.0 kHz
FM Peak Deviation Increment: 1 kHz
Sequence Counter: Resets to 0

Comments

Performing this feature does not affect any saved front panel set-ups.

Related Instructions

None

Modulation, AM

Description

This instruction details how to select Internal Amplitude Modulation.

Keystroke Sequence

Press an Internal Source key, the AM function key, the desired Data keys, and a valid Units key. (You do not need to press an Internal Source key if you require a 1 kHz modulation rate).

Example

Select Internal AM with a modulation depth of 75% and a modulation rate of 400 Hz.

LOCAL (keys)	SOURCE	FUNCTION	DATA	UNITS
	INT 400 Hz	AM	7 5	%
HP-IB (program codes)	S2 AM 75 PC or %			

Keys and Program Codes

Keys	Codes
INT 400 Hz	S2
INT 1 kHz	S3
AM	AM
%	PC or %

Indications

Selected AM depth is displayed in the MODULATION Display, and the source annunciators (INT AM, 400 Hz, and %) will light.

Comments

Digits selected beyond the specified resolution for AM depth are truncated.

Leading zeros are blanked.

AM depth Data entries that would cause the peak envelope power of the Signal Generator to exceed +17 dBm are rejected.

The External Source key may be selected in place of the Internal Source key.

AM function remains selected until:

- a. One of the three remaining functions is selected (AMPTD, FM, or FREQUENCY).
- b. One of the SAVE, RECALL, SEQUENCE keys or Display (SHIFT, DSPL) is pressed.
- c. The Signal Generator is preset, unplugged, or switched to standby.

A one key sequence acts as a select between the two internal modulation sources.

Only one internal modulation source can be selected at any time either 400 Hz or 1 kHz.

Related Instructions

- Modulation, AM Up/Down
- Modulation, External Source
- Modulation, Mixed
- Modulation, Off
- Modulation, Pulse
- Modulation, Pulse (Fast Mode)

Modulation, AM Up/Down

Description

This instruction details how to change the percentage of AM depth by the stored value of AM depth increment.

Keystroke Sequence

Press the AM↑ or AM↓ key.

Keys and Program Codes

Keys	Codes
AM ↑ ↓	AM UP DN

NOTE

In remote operation, repeated UP or DN codes can be sent over the bus once the AM function is selected.

Indications

The percentage of AM depth changes by the stored value of AM depth increment.

Comments

Performing this feature:

- Places the Signal Generator in the AM Data entry mode, and clears any previously selected function.
- Selects default modulation source (internal 1 kHz) if no other source is selected.
- Will automatically stop incrementing when the maximum percentage of AM depth permitted for a selected output amplitude is reached.
- Continues to change the percentage of AM depth by the value stored in the AM depth increment register if either key remains pressed.

If the AM depth increment is set to a value that would cause the Signal Generator to exceed a modulation depth of 1 to 99% (for the HP 8656B and HP 8657A) or 1 to 100% (for the HP 8657B), either the AM↑ or AM↓ key becomes inoperative (determined by which limit would be exceeded). A correct decrease in the increment setting re-enables the AM↑ or AM↓ key.

Increment entries are checked against maximum and minimum allowable increment limits. If an AM depth increment limit is exceeded the entry is truncated.

Initialized value and limits of the AM depth increment are as follows:

Model	Initialized Value	Minimum Value	Maximum Value
HP 8656B	1%	1%	≤ 99%
HP 8657A	1%	1%	≤ 99%
HP 8657B	1%	1%	≤ 100%

Related Instructions

- Increment Value Change
- Increment Value Display
- Modulation, AM
- Modulation, Off
- Modulation, DC FM Up/Down
- Modulation, FM Up/Down
- Modulation, Pulse
- Modulation, Pulse (Fast Mode)

Modulation, DC FM

Description

This instructions details how to select DC FM modulation.

CAUTION

Maximum allowable input level is ± 15 Vdc. Exceeding this limit may cause damage to the Signal Generator.

Keystroke Sequence

Press the SHIFT key, the FM function key, the desired Data Keys and a valid Units key.

Example

Select DC FM with a peak deviation of 50 kHz.

LOCAL (keys)	FUNCTION	DATA	UNITS
	<div style="display: flex; justify-content: space-around;"> SHIFT FM </div>	<div style="display: flex; justify-content: space-around;"> 5 0 </div>	<div style="display: flex; justify-content: center;"> kHz </div>
HP IB (program codes)	S5 50 KZ		

Keys and Program Codes

Keys	Codes
DC FM kHz	S5 KZ

Indications

Selected DC FM peak deviation are displayed in the MODULATION Display, and the Modulation annunciators (DC FM, EXT FM, and LO EXT) will light.

Comments

Selecting DC FM automatically enables the front-panel MOD INPUT/OUTPUT connector for an external modulation source.

The LO EXT Modulation annunciator remains on regardless of the dc input level applied to the MOD INPUT/OUTPUT connector.

The LO EXT Modulation annunciator turns off if external AM or FM is selected along with DC FM, and the external source has been adjusted to 1 Vpk (0.707 Vrms \pm 5%).

Digits selected beyond the specified resolution for DC FM peak deviation are truncated.

Leading zeros are blanked.

DC FM peak deviation Data entries that would be out-of-range for the selected carrier frequency are rejected.

If you select a carrier frequency that makes the currently selected FM Peak Deviation outside the Signal Generator operating limits, then the MODULATION Display flashes. To clear this error condition enter a new carrier frequency in the correct band for the selected Peak Deviation. To automatically select the maximum permitted Peak Deviation for the carrier frequency, press the FM, FM \uparrow or FM \downarrow key.

DC FM function remains selected until:

- a. One of the three remaining functions is selected (AM, AMPTD, or FREQUENCY).
- b. One of the SAVE, RECALL, SEQUENCE keys or Display (SHIFT, DSPL) is pressed.
- c. The Signal Generator is preset, unplugged, or switched to standby.

Related Instructions

Modulation, DC FM Up/Down

Modulation, External Source

Modulation, Mixed

Modulation, Off

Modulation, Pulse

Modulation, Pulse (Fast Mode)

Modulation, DC FM Up/Down

Description

This instruction details how to change the DC FM peak deviation by the stored value of FM peak deviation increment.

Keystroke Sequence

Press the FM \uparrow or FM \downarrow key.

Keys and Program Codes

Keys	Codes
DC FM	S5
\uparrow	UP
\downarrow	DN

NOTE

During remote operation, repeated UP or DN codes can be sent over the bus once the DC FM function is selected.

Indications

The DC FM peak deviation changes by the stored value of FM peak deviation increment.

Comments

Performing this feature:

- Continues to change the DC FM peak deviation by the stored value of FM peak deviation increment if either key remains pressed.
- Will automatically stop incrementing when the maximum FM peak deviation permitted for a selected carrier frequency is reached.

If an out-of-range condition exists (MODULATION Display flashing) pressing either the FM, FM \uparrow or FM \downarrow key automatically selects the maximum FM peak deviation permitted for the currently selected carrier frequency.

Initialized value and limits of the FM peak deviation increment

are as follows:

Model	Initialized Value	Minimum Value	Maximum Value
HP 8656B	1 kHz	0.1 kHz	≤ 99 kHz
HP 8657A	1 kHz	0.1 kHz	≤ 99 kHz
HP 8657B	1 kHz	0.1 kHz	≤ 400 kHz

NOTE

The maximum value of FM peak deviation increment you can select is determined by the Carrier Frequency selected.

Related Instructions

- Increment Value Change
- Increment Value Display
- Modulation, AM Up/Down
- Modulation, DC FM
- Modulation, FM Up/Down
- Modulation, Off
- Modulation, Pulse
- Modulation, Pulse (Fast Mode)

Modulation, External Source

Description

This instruction details how to apply an external modulation signal via the front-panel MOD INPUT/OUTPUT connector.

Keystroke Sequence

Press the EXT key to enable the front-panel MOD INPUT/OUTPUT connector, then set the signal level of the external modulation source to 1 Vpk (0.707 Vrms) for calibrated internal control of the AM depth or FM peak deviation.

Keys and Program Codes

Keys	Codes
AM	AM
FM	FM
EXT	S1
%	% or PC
kHz	KZ

Indications

The HI EXT annunciator lights if the external modulation signal is greater than 1.02 Vpk (0.721 Vrms), and the LO EXT annunciator lights if the signal is less than 0.98 Vpk (0.693 Vrms). Both annunciators are off when the input level is 1.00 ± 0.02 Vpk (0.707 Vrms), except when exclusively in the DC FM Mode in which case the LO EXT annunciator remains on.

NOTE

If greater accuracy is required, use a calibrated voltmeter to measure the external modulation signal.

Comments

The 400 Hz or 1 kHz modulation signal is available at the MOD INPUT/OUTPUT connector when INTERNAL modulation is selected (level 1 Vpk - 0.707 Vrms).

For AM or FM the front-panel MOD INPUT/OUTPUT connector is ac coupled. For DC FM the front-panel MOD INPUT/OUTPUT connector is dc coupled.

Related Instructions

- Modulation, AM
- Modulation, DC FM
- Modulation, FM
- Modulation, Mixed
- Modulation, Off
- Modulation, Pulse
- Modulation, Pulse (Fast Mode)

Modulation, FM

Description

This instruction details how to select Internal Frequency Modulation.

Keystroke Sequence

Press an internal Source key, the FM Function key, the desired Data keys, and a valid Units key (you do not need to press an Internal Source key if you require a 1 kHz modulation rate).

Example

Select Internal FM with a peak deviation of 25 kHz and a modulation rate of 400 Hz.

LOCAL (keys)	SOURCE	FUNCTION	DATA	UNITS
	INT 400 Hz	FM	2 5	kHz
HP-IB (program codes)	S2 FM 25 KZ			

Keys and Program Codes

Keys	Codes
FM	FM
INT 400 Hz	S2
INT 1 kHz	S3
kHz	KZ

Indications

The FM peak deviation is displayed in the MODULATION Display, and the source annunciators (INT FM and 400 Hz) light.

Comments

Digits selected beyond the specified resolution for FM peak deviation are truncated.

Leading zeros are blanked.

A one-key sequence acts as a select between the two internal modulation sources.

The External Source key may be selected in place of the Internal Source key.

Only one internal modulation source can be selected at any time, either 400 Hz or 1 kHz.

FM peak deviation Data entries are rejected if they would cause the selected carrier frequency to be out-of-range.

If you select a carrier frequency that makes the currently selected FM Peak Deviation outside the Signal Generator operating limits, then the MODULATION Display flashes. To clear this error condition enter a new carrier frequency in the correct band for the selected Peak Deviation. To automatically select the maximum permitted Peak Deviation for the carrier frequency, press the FM, FM↑ or FM↓ key.

The FM function remains selected until:

- a. One of the three remaining functions is selected (AM, AMPTD, or FREQUENCY).
- b. One of the SAVE, RECALL, SEQUENCE keys or Display (SHIFT, DSPL) is pressed.
- c. The Signal Generator is preset, unplugged, or switched to standby.

Related Instructions

Modulation, FM Up/Down

Modulation, External Source

Modulation, Mixed

Modulation, Off

Modulation, Pulse

Modulation, Pulse (Fast Mode)

Modulation, FM Up/Down

Description

This instruction details how to change the FM Peak Deviation by the stored value of FM Peak Deviation increment.

Keystroke Sequence

Press the FM↑ or FM↓ key.

Keys and Program Codes

Keys	Codes
FM ↑	FM UP
FM ↓	FM DN

NOTE

In remote operation, repeated UP or DN codes can be sent over the bus once the FM function is selected.

Indications

The FM peak deviation changes by the stored value of FM peak deviation increment.

Comments

If the FM peak deviation increment is set to a value that would cause the Signal Generator to exceed its peak deviation range, the step-up and step-down keys become inoperative. A correct decrease in the increment setting re-enables the step-up and step-down keys.

Performing this feature:

- Places the Signal Generator in the FM Data entry mode, and clears any previously selected function.
- Selects default modulation source (internal 1 kHz) if no other source is selected.
- Continues to change the FM peak deviation by the value stored in the FM peak deviation increment register if either key remains pressed.
- Will automatically stop incrementing when the maximum FM peak deviation permitted for a selected carrier frequency is reached.

If an out-of-range condition exists (MODULATION Display flashing), pressing either the FM, FM↑ or FM↓ key automatically selects the maximum FM peak deviation permitted for the currently selected carrier frequency.

Increment entries are checked against maximum and minimum allowable increment limits. If a limit is exceeded, the increment entry is either truncated or rejected.

Initialized value and limits of the FM peak deviation increment are as follows:

Model	Initialized Value	Minimum Value	Maximum Value
HP 8656B	1 kHz	0.1 kHz	≤ 99 kHz
HP 8657A	1 kHz	0.1 kHz	≤ 99 kHz
HP 8657B	1 kHz	0.1 kHz	≤ 400 kHz

NOTE

The maximum value of FM peak deviation increment you can select is determined by the Carrier Frequency selected.

Related Instructions

Increment Value Change
 Increment Value Display
 Modulation, AM Up/Down
 Modulation, FM
 Modulation, DC FM Up/Down
 Modulation, Off
 Modulation, Pulse
 Modulation, Pulse (Fast Mode)

Modulation, Mixed

Description

These instructions detail the selection of mixed modulation. Modulation is selected in one of six ways.

1. Simultaneous AM and FM is selected using common or separate modulation sources (rate).
2. Simultaneous AM or FM at two rates is selected by using internal and external modulation sources. Only one AM depth or one FM deviation can be selected.
3. Three simultaneous modulation signals, AM and FM using a common source (rate) and either AM or FM from a separate source, may be selected.
4. Four simultaneous modulation signals, two AM and two FM, may be selected. Each AM/FM pair must have a common modulation source (rate). Only one AM depth and one FM deviation can be selected.
5. DC FM may be selected and entered along with any of the four ways mentioned in statements 1 to 4.
6. Pulse Modulation may be selected along with AM and FM (Internal and/or External) and/or DC FM Modulation (Option 003 only). Pulse Modulation is available as an option on the HP 8657B only.

Keystroke Sequence 1

To select simultaneous AM and FM, press the Source key to provide the desired AM rate, the AM Function key, the desired Data keys, and the % Units key. Then press the Source key to provide the desired FM rate, the FM Function key, the desired Data keys, and the kHz Units key. (The Source key need not be pressed for FM if the AM and FM rate is the same. Only one internal rate can be used at a time.)

Example 1

Simultaneously select AM with a depth of 70% and FM with a peak deviation of 3 kHz using the internal 400 Hz source, and an external 1 kHz source respectively.

	SOURCE	FUNCTION	DATA	UNITS
LOCAL (keys)	INT 400 Hz	AM	7 0	%
	EXT	FM	3	kHz
HP-IB (program codes)	S2 AM 70 PC or % S1 FM 3 KZ			

Keystroke Sequence 2

To select simultaneous AM or FM, press the desired Source key, the desired Function key, the desired Data keys, and a valid Units key. Then press the other Source key, and the same Function key that was selected previously.

Example 2

Select FM with a peak deviation of 5 kHz using both an internal 1 kHz modulation source and an external 150 Hz modulation source.

	SOURCE	FUNCTION	DATA	UNITS
LOCAL (keys)	INT 1 kHz	FM	5	kHz
	EXT	FM		
HP-IB (program codes)	S3 FM 5 KZ S1 FM			

Keystroke Sequence 3

To select three simultaneous modulation signals, AM and FM using a common source (rate) and AM or FM from a separate source, press the Source key to provide the common AM and FM rate. Then press a Function key, the desired Data keys, and the valid Units key. Press the other Function key, the desired Data keys, and the valid Units key. Press the other Source key, the appropriate Function key, the desired Data keys, and the valid Units key.

Example 3

Simultaneously select AM with a depth of 90% and FM with a peak deviation of 25 kHz using the internal 400 Hz source, and AM with a depth of 90% using an external 6 kHz modulation source.

	SOURCE	FUNCTION	DATA	UNITS
LOCAL (keys)	INT 400 Hz	AM	9 0	%
		FM	2 5	kHz
	EXT	AM		
HP-IB (program codes)	S2 AM 90 PC or % FM 25 KZ S1 AM			

Keystroke Sequence 4

To select four simultaneous modulation signals, press the appropriate Source key, a Function key, the desired Data keys, and the valid Units key. Press the other Function key, the desired Data keys and valid Units key. Press the other Source key, and then both Function keys.

Example 4

Simultaneously select AM with a depth of 10% and FM with a peak deviation of 50 kHz using the internal 1 kHz modulation source. AM and FM with the same depth and deviation as selected previously are also selected using an external 5 kHz source.

	SOURCE	FUNCTION	DATA	UNITS
LOCAL (keys)	INT 1 kHz	AM	1 0	%
		FM	5 0	KHZ
	EXT	AM		
	EXT	FM		
HP-IB (program codes)	S3 AM 10 PC or % FM 50 KZ S1 AM S1 FM			

Keys and Program Codes

Keys	Codes
AM	AM
FM	FM
EXT	S1
INT 400 Hz	S2
INT 1 kHz	S3
DC FM	S5
PULSE	PM
PULSE (Fast)	PF

Indications

The last selected AM depth or FM peak deviation is displayed in the MODULATION Display, and the source annunciators will light. In the case where an external modulation source is used, the HI EXT and LO EXT annunciators will also light until the signal level of the external source is adjusted to 1 Vpk (0.707 Vrms) ±5%.

Comments

Digits selected beyond the specified resolution for AM depth or FM peak deviation are truncated.

Leading zeros are blanked.

AM depth Data entries that would cause the peak envelope power of the Signal Generator to exceed +17 dBm are rejected.

FM peak deviation Data entries that are out-of-range for the selected carrier frequency are rejected.

If you select a carrier frequency that makes the currently selected FM Peak Deviation outside the Signal Generator operating limits, then the MODULATION Display flashes. To clear this error condition enter a new carrier frequency in the correct band for the selected Peak Deviation. To automatically select the maximum permitted Peak Deviation for the carrier frequency, press the FM, FM \uparrow or FM \downarrow key.

HP 8656B Carrier Frequency (MHz)	Maximum Peak Deviation	
	AC Mode	DC Mode
	(the lesser of)	
0.1 to 123.5	99 kHz or 4000 \times rate (Hz)	99 kHz
123.5 to 247	50 kHz or 1000 \times rate (Hz)	50 kHz
247 to 494	99 kHz or 2000 \times rate (Hz)	99 kHz
494 to 990	99 kHz or 4000 \times rate (Hz)	99 kHz

HP 8657A Carrier Frequency (MHz)	Maximum Peak Deviation	
	AC Mode	DC Mode
	(the lesser of)	
0.1 to 130	99 kHz or 4000 \times rate (Hz)	99 kHz
130 to 260	50 kHz or 1000 \times rate (Hz)	50 kHz
260 to 520	99 kHz or 2000 \times rate (Hz)	99 kHz
520 to 1040	99 kHz or 4000 \times rate (Hz)	99 kHz

HP 8657B Carrier Frequency (MHz)	Maximum Peak Deviation	
	AC Mode	DC Mode
	(the lesser of)	
0.1 to 130	200 kHz or 4000 \times rate (Hz)	200 kHz
130 to 260	50 kHz or 1000 \times rate (Hz)	50 kHz
260 to 520	100 kHz or 2000 \times rate (Hz)	100 kHz
520 to 1040	200 kHz or 4000 \times rate (Hz)	200 kHz
1040 to 2060	400 kHz or 8000 \times rate (Hz)	400 kHz

The AM or FM function remains selected until:

- One of the three remaining functions is selected.
- One of the SAVE, RECALL, SEQUENCE keys or Display (SHIFT, DSPL) is pressed.
- The Signal Generator is preset, unplugged, or switched to standby.

Setting the level of the external modulation source is described under Modulation, External Source.

Related Instructions

- Modulation, AM**
- Modulation, DC FM**
- Modulation, External Source**
- Modulation, FM**
- Modulation, OFF**
- Modulation, Pulse**
- Modulation, Pulse (Fast Mode)**

Modulation, Off

Description

This instruction details how to selectively turn off Modulation functions and sources.

Keystroke Sequences

To turn off a modulation function (AM or FM), press the Function key, then the OFF key.

To turn off a modulation source (internal 400 Hz, internal 1 kHz, or external), press the associated Function key, Source key, then the OFF key.

To turn off Pulse Modulation, when only Pulse Modulation is selected, press the OFF key. To turn off Pulse Modulation, when Pulse Modulation is selected with AM or FM, press the PULSE then the OFF key.

To turn off Pulse Modulation (Fast Mode), when only Pulse Modulation (Fast Mode) is selected, press the OFF key. To turn off Pulse Modulation (Fast Mode), when it is selected with AM or FM, press the SHIFT key, then the ↑ key below the AM function key, then the OFF key.

NOTE

Pulse Modulation is available as an option on the HP 8657B only.

Examples

Selectively turn off AM modulation function with only one modulation source in use.

	FUNCTION	SOURCE
LOCAL (keys)	AM	OFF
HP-IB (program codes)	AM S4	

Selectively turn off internal 400 Hz source.

	FUNCTION	SOURCE
LOCAL (keys)	AM	INT 400 Hz OFF
HP-IB (program codes)	AM S2 S4	

Keys and Program Codes

Keys	Codes
AM	AM
FM	FM
EXT	S1
INT 400 Hz	S2
INT 1 kHz	S3
OFF	S4
DC FM	S5
PULSE	PM
PULSE (Fast)	PF

Indications

The current MODULATION Display is blanked or the modulation source (including its annunciator) is turned off when the OFF key is pressed. Subsequently pressing a modulation key switches on the modulation and recalls the previous modulation value.

Comments

The currently selected modulation function (AM or FM) is turned off when the OFF key is pressed, provided only one source (internal 400 Hz or 1 kHz, or external) is selected for use. Subsequently pressing this modulation key switches on the modulation and recalls the previous modulation value.

If more than one source is selected, then a Source key (INT 400 Hz, INT 1 kHz, or EXT) has to be pressed before the OFF key is pressed. In this case, the currently selected modulation function remains selected, and only the chosen source (including its annunciator) is turned off.

If both modulation functions are simultaneously selected and share the same source, then; only the currently selected modulation function is turned off when the OFF key is pressed, and the MODULATION Display is restored to show the modulation parameters of the remaining function.

Related Instructions

- Modulation, AM
- Modulation, AM Up/Down
- Modulation, DC FM
- Modulation, DC FM Up/Down
- Modulation, FM
- Modulation, FM Up/Down
- Modulation, External Source
- Modulation, Mixed
- Modulation, Pulse
- Modulation, Pulse (Fast Mode)

Modulation, Pulse

Description

This instruction details how to select Pulse Modulation.

NOTE

Pulse Modulation is available as an option on the HP 8657B only.

CAUTION

Maximum allowable input level is ± 15 Vdc. Exceeding this limit may cause damage to the HP 8657B.

Keystroke Sequence

Press the SHIFT key then the AM function key. Connect the external modulation source to the PULSE INPUT. When the pulse waveform from the external source goes high, the pulse output from the HP 8657B turns on. Vary the external pulse rate, amplitude and width to simulate the pulse modulated signal you require.

Keys and Program Codes

Keys	Codes
PULSE	PM

Indications

The PULSE annunciator lights.

Comments

The Pulse Input Impedance can be selected for 50 ohms or high impedance. The factory setting is high impedance. If you want to select 50 ohms, refer to paragraph 2-15.

When the carrier frequency is ≥ 1030 MHz, and the Amplitude or Frequency is changed when Pulse Modulation is selected, the HP 8657B performs a calibration on the output level. During this calibration the attenuator is switched in to prevent the calibration signal from appearing at the RF OUTPUT.

If the HP 8657B is being used in an automated test system where the Frequency or Amplitude is modified when Pulse Modulation is selected and the carrier frequency is ≥ 1030 MHz, then attenuator life can be extended by selecting Pulse Modulation (Fast Mode).

Refer to paragraph 3-7 for more information about selecting the best mode of Pulse Modulation for your application.

CAUTION

For carrier frequencies ≥ 1030 MHz, the HP 8657B performs a calibration on the output level when Pulse Modulation (Fast Mode) is first selected, or when the Amplitude or Frequency is modified with Pulse Modulation (Fast Mode) selected.

During this calibration, a calibration pulse appears at the RF OUTPUT for approximately 15 ms.

Check the specifications of any equipment which the HP 8657B is being used to test, to ensure that the calibration pulse will not cause any damage.

Related Instructions

Modulation, AM
Modulation, AM Up/Down
Modulation, External Source
Modulation, Mixed
Modulation, Off
Modulation, Pulse (Fast Mode)

Modulation, Pulse (Fast Mode)

Description

This instruction details how to select Pulse Modulation (Fast Mode).

NOTE

Pulse Modulation is available as an option on the HP 8657B only.

CAUTION

Maximum allowable input level is ± 15 Vdc. Exceeding this limit may cause damage to the HP 8657B.

Keystroke Sequence

Press the SHIFT key then the \uparrow key below the AM function key. Connect the external modulation source to the PULSE INPUT. When the pulse waveform from the external source goes high, the pulse output from the HP 8657B turns on. Vary the external pulse rate, amplitude and width to simulate the pulse modulated signal you require.

Keys and Program Codes

Keys	Codes
FAST PULSE	PF

Indications

The PULSE annunciator lights.

Comments

The Pulse Input Impedance can be selected for 50 ohms or high impedance. The factory setting is high impedance. If you want to select 50 ohms, refer to paragraph 2-15.

CAUTION

For frequencies ≥ 1030 MHz, the HP 8657B performs a calibration on the output level when Pulse Modulation (Fast Mode) is first selected, or when the Amplitude or Frequency is modified with Pulse Modulation (Fast Mode) selected.

During this calibration, a calibration pulse appears at the RF OUTPUT for approximately 15 ms.

Check the specifications of any equipment which the HP 8657B is being used to test, to ensure that the calibration pulse will not cause any damage.

If the calibration pulse will cause damage, then select Pulse Modulation. However, in high cycle applications using frequencies ≥ 1030 MHz, this may reduce the life of the HP 8657B attenuator. This is because when the Amplitude or Frequency is changed when Pulse Modulation is selected, the HP 8657B performs a calibration on the output level. During this calibration the attenuator is switched in to prevent the calibration signal from appearing at the RF OUTPUT.

Refer to page 3-15 for more information about selecting the best mode of Pulse modulation for your application.

Related Instructions

Modulation, AM
Modulation, AM Up/Down
Modulation, External Source
Modulation, Mixed
Modulation, Off
Modulation, Pulse

Recall

Description

This instruction details how to recall a saved front-panel set-up.

Keystroke Sequence

Press the **RECALL** key, and then use the Data keys to recall the set-up you want.

Example

Recall the front-panel set-up saved in memory location 02.

LOCAL (keys)	RECALL	0	2
HP-IB (program codes)	RC 02		

Keys and Program Codes

Keys	Codes
RECALL	RL

Indications

The front-panel display will flash after the second numeric value is entered and the front-panel set-up saved in memory location 02 is recalled and the Signal Generator output is changed to the new set-up.

Comments

You can save up to 100 (0-99) complete front-panel set-ups (exclusive of increment settings).

NOTE

If the Non-Volatile memory battery needs replaced (frequency display shows decimal points on the HP 8656B and HP 8657A or CLEARING on the HP 8657B at power on), then you cannot use the recall feature. For information about the battery refer to Section 2.

To clear all your front-panel set-ups from memory, press and hold the ← key at switch on. The FREQUENCY display will show decimal points (on the HP 8656B and HP 8657A) or CLEARING (on the HP 8657B) to confirm that the memory is being cleared.

Related Instructions

Display
Save
Sequence

RF ON/OFF

Description

This instruction details how to turn OFF and ON the carrier frequency at the RF OUTPUT of the Signal Generator.

Keystroke Sequence

Press the RF ON/OFF key.

Keys and Program Codes

Keys	Codes
RF OFF	R2
RF ON	R3
SHIFT RF OFF	R5 ⁽¹⁾
(1) HP 8657B only	

Indications

The AMPLITUDE Display, and Amplitude annunciators are blanked when RF ON/OFF is off. Pressing RF ON/OFF again turns on the RF and restores the AMPLITUDE Display and annunciators.

Comments

The RF ON/OFF key turns off the carrier frequency to the output without affecting the attenuators.

HP 8657B ONLY : If your application includes measuring equipment sensitive to noise (i.e receivers), pressing the SHIFT key and then the RF ON/OFF key will reduce spurious noise by switching in all the attenuator pads.

Performing this feature does not affect the current set-up.

Related Instructions

None

Save

Description

This instruction details how to save complete front-panel set-ups (exclusive of increment settings) in Non-Volatile Memory.

Keystroke Sequence

Press the SAVE key, then two Data keys sequentially to identify the memory location of the set-up.

Example

Save the current front-panel set-up in memory location 02.

LOCAL (keys)	SAVE	0	2
HP IB (program codes)	SV 02		

Keys and Program Codes

Keys	Code
Save	SV

Indications

The current instrument state will be saved in register XX (register 02 in the above example). The display will also flash after the second numeric value is entered. The sequence pointer associated with register XX will default to XX+1 (register 03 in the above example).

Comments

You can save up to 100 (0-99) front-panel set-ups.

NOTE

If the Non-Volatile memory battery needs replaced (frequency displays shows decimal points on the HP 8656B and HP 8657A or CLEARING on the HP 8757B at power on), then you cannot use the recall feature. For information about the battery refer to Section 2.

To clear all your front-panel set-ups from memory, press and hold the ← key at switch on. The FREQUENCY display will show decimal points (on the HP 8656B and HP 8657A) or CLEARING (on the HP 8657B) to confirm that the memory is being cleared.

Related Instructions

- Display
- Recall
- Sequence

Sequence

Description

This instruction details how to recall a sequence of saved front-panel set-ups.

Keystroke Sequence

Use the SAVE and DATA keys to save the set-ups you want. Press the RECALL and DATA keys to recall the set-up you want the sequence to start at. Press the SEQ key to recall the next set-up.

Keys and Program Codes

Keys	Codes
SEQ	SQ
Flexible ¹	GT
Reverse ¹	QS
(1) See comments.	

Indications

Each time you press the SEQ key, the next front-panel set-up is recalled and the Signal Generator is changed to the new set-up.

Comments

You can save up to 100 (0-99) complete front-panel setups (exclusive of increment settings).

NOTE

If the Non-Volatile memory battery needs replaced (frequency displays shows decimal points on the HP 8656B and HP 8657A or CLEARING on the HP 8657B at power on), then you cannot use the recall feature. For information about the battery refer to Section 2.

To clear all your front-panel set-ups from memory, press and hold the ← key at switch on. The FREQUENCY display will show a line of decimal points (HP 8656B/57A) or CLEARING (HP 8657B) to confirm that the memory is being cleared. This will set all memory location pointers to their default locations (i.e location 00 will point to location 01).

To create a flexible sequence, recall the last set-up in your sequence. Then press SHIFT, SAVE and XXYY where XX is the memory location of the current set-up and YY is the location of the set-up you want to sequence to. For example, to create a flexible sequence of 00 ⇒ 01 ⇒ 02 ⇒ 03 ⇒ 00, recall set-up 03. To see where this set-up is currently pointing to, press SHIFT, SEQ and hold the SEQ key. The default display will be 0304. To create the flexible sequence, press SHIFT, SAVE and 0300. Storage register 03 will now sequence back to register 00 instead of going on to register 04.

To reverse the sequence, press SHIFT, SEQ and RECALL. When the Signal Generator reaches set-up 00, the next keystroke sequence will recall set-up 03. Repeatedly keying SHIFT, SEQ, RECALL will result in the sequence 03 ⇒ 02 ⇒ 01 ⇒ 00 ⇒ 03 being carried out.

There can be a conflict when reverse sequencing if more than one register is pointing to the current sequence register. For example, if the current sequence register is 05 and registers 10 and 15 both point to 05, a reverse sequence operation could go to either register 10 or 15. When this conflict arises, the register which is recalled is the first one found by searching forward in the sequence table. In this case, register 10 would be recalled.

Both the flexible and reverse sequencing can be controlled via the HPIB codes shown. Code GT is used to flexibly sequence forward and code QS is used for reverse sequencing.

Related Instructions

- Display
- Display Sequence
- Recall
- Store

3-10. USER CONFIDENCE TESTS

The User Confidence Tests provide procedures to allow you to check that the Signal Generator is operating correctly. Two sets of tests are provided; Basic Functional Checks and HP-IB Functional Checks

3-11. BASIC FUNCTIONAL CHECKS

Description

This procedure requires a frequency counter, a spectrum analyzer, a power supply, and the interconnecting cables and adapters. It provides assurance that most of the front-panel controlled functions are being executed by the Signal Generator.

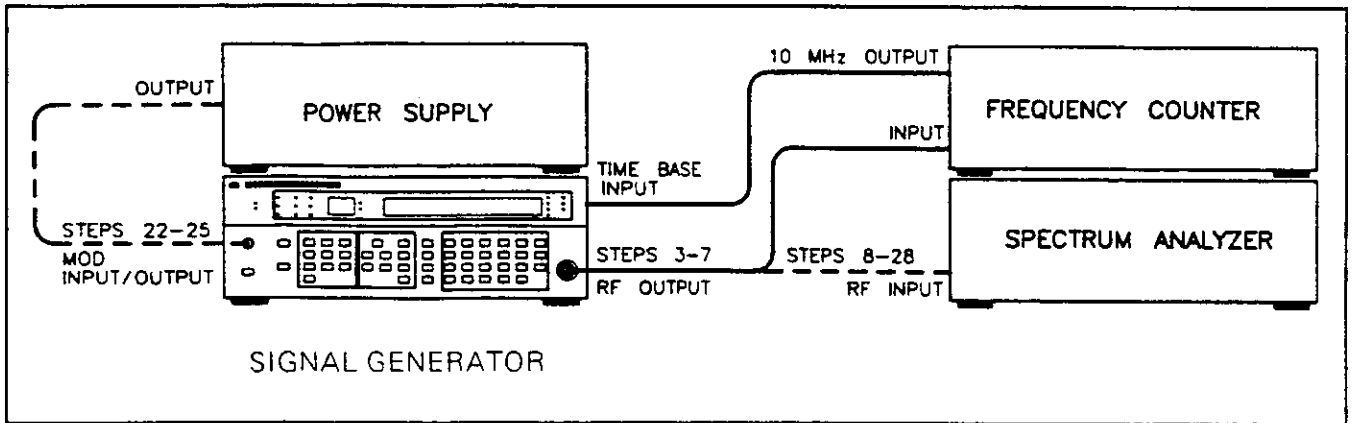

Figure 3-3. Test Setup for Basic Functional Checks

Equipment

Frequency Counter	HP 5328A Option 031
Spectrum Analyzer	HP 8668B/182T
Power Supply	HP 6235A

Procedure

1. Ensure that the power cable is plugged into a suitable source of Mains power (refer to paragraph 2-4).
2. Switch-on the Signal Generator by presing the POWER key. The Signal Generator automatically performs a self-test check at power on (this takes approximately 6 seconds). During this time all front panel indicators and displays will light.

When the self-test is complete, the Signal Generator is set to the same conditions as when it was switched off.

NOTE

If the Signal Generator is switched off with RF ON/OFF set to OFF, then it will power-on with RF set to ON.

If any of the self-tests fail at power-on, an error code is displayed in the FREQUENCY window. The error code remains displayed until any front panel key is pressed.

3. Connect the RF OUTPUT of the Signal Generator to the input of the frequency counter, and the 10 MHz reference output from the frequency counter to the TIME BASE INPUT located at the rear of the Signal Generator as shown in Figure 3-2.

Connecting the 10 MHz reference output of the frequency counter to the TIME BASE INPUT of the Signal Generator phase locks the two instruments to the same time base reference.

NOTE

If the Signal Generator is equipped with the high stability time base (Option 001), disconnect its cable from the TIME BASE INPUT before performing this step.

Frequency Check

4. Set the output amplitude of the Signal Generator to -10.0 dBm and the carrier frequency to the values listed in the following table. The values are suitable for any Signal Generator unless otherwise stated in the table.

Carrier Frequency (MHz)
100.000000
140.000000
200.000000
300.000000
400.000000
600.000000
800.000000
990.000000
1030.000000 ¹
1040.000000 ¹
2060.000000 ²
¹ HP 8657A/B only. ² HP 8657B only.

Verify that the FREQUENCY Display on the Signal Generator agrees with the frequency displayed on the frequency counter (except for the resolution of the frequency counter being used).

5. Set the carrier frequency of the Signal Generator to 111.111111 MHz and the frequency increment value to 111.111111 MHz. Leave the output amplitude set at -10.0 dBm.

Verify that the FREQUENCY display on the Signal Generator agrees with the frequency displayed on the frequency counter.

6. Quickly press and release the frequency step-up key to increase the carrier frequency.

Verify that the FREQUENCY Display on the Signal Generator agrees with the frequency displayed on the frequency counter.

Continue to increase the carrier frequency to the maximum value listed in the following table:

Carrier Frequency (MHz)
111.111111
<u>222.222222</u>
333.333333
444.444444
555.555555
666.666666
777.777777
888.888888
999.999999 ¹
1111.111110 ²

¹HP 8657A/B only.
²HP 8657B only.

Verify that the FREQUENCY Display on the Signal Generator agrees with the frequency displayed on the frequency counter each time the carrier frequency is increased.

7. Quickly press and release the frequency step-down key to decrease the carrier frequency.

Verify that the FREQUENCY Display on the Signal Generator agrees with the frequency displayed on the frequency counter.

Continue to decrease the carrier frequency to the minimum value listed in the previous table.

Verify that the FREQUENCY Display on the Signal Generator agrees with the frequency displayed on the frequency counter each time the carrier frequency is decreased.

Output Level Checks

8. Connect the RF OUTPUT of the Signal Generator to the input of the spectrum analyzer as shown in Figure 3-3.
9. Set the output amplitude of the Signal Generator to 0.0 dBm, carrier frequency to 0.1 MHz, and frequency increment value to 10 MHz.
10. Set the amplitude scale of the spectrum analyzer to display 1 dB/division, and make the necessary adjustments to properly display the output signal from the Signal Generator.

NOTE

This check only verifies level flatness, it does not verify absolute level accuracy.

11. Slowly increase the carrier frequency through its entire calibrated frequency range (0.1 to 2060 MHz) and observe the level displayed on the spectrum analyzer. The level should not vary more than a total of 2 dBm (± 1.0 dB from 0.0 dBm).

12. Set the carrier frequency of the Signal Generator to 600 MHz, output amplitude to +13 dBm, and output amplitude increment value to 1.0 dB.
13. Adjust the spectrum analyzer as necessary to display the output signal from the Signal Generator. The displayed carrier should be positioned in the center of the graticule with its maximum level positioned near the top of the graticule.
14. Slowly decrease the output amplitude down to -4.0 dBm and observe the level displayed on the spectrum analyzer. The level should decrease in relatively uniform 1 dB steps.
15. Set the output amplitude of the Signal Generator to -10.0 dBm and the output amplitude increment value to 5 dB. Leave the carrier frequency set to 600 MHz.
16. Set the amplitude scale of the spectrum analyzer to display 10 dB/division and make the necessary adjustments to properly display the output signal from the Signal Generator. The displayed carrier should be positioned in the center of the graticule with its maximum level positioned near the top of the graticule.
17. Slowly decrease the output amplitude down to -80 dBm and observe the level displayed on the spectrum analyzer. The level should decrease in relatively uniform 5 dB steps.

FM Check

18. Set the output amplitude of the Signal Generator to 0.0 dBm. Leave the carrier frequency set to 600 MHz. Select FM with a peak deviation of 99 kHz using the internal 1 kHz source. Set the FM peak deviation increment value to 1 kHz.
19. Set the spectrum analyzer for a 50 kHz frequency span/division, a resolution bandwidth of 3 kHz, and a reference level of 0 dBm. The waveform displayed should be similar to that shown in Figure 3-4.

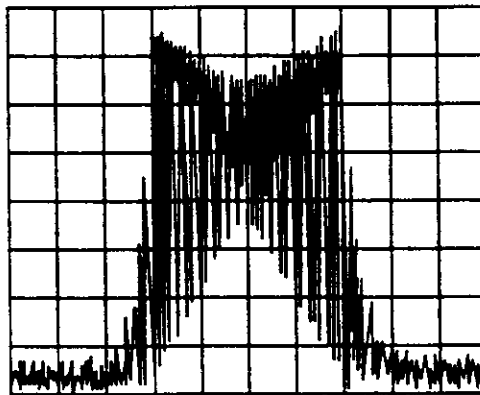

Figure 3-4. FM Functional Check Waveform

20. Slowly decrease the FM peak deviation to zero. The deviation displayed on the spectrum analyzer should decrease in relatively uniform steps.
21. Press FM, then OFF to turn off the FM function.

DC FM Check

22. Leave the output amplitude of the Signal Generator set to 0.0 dBm, and the carrier frequency set to 600 MHz. Select external DC FM with a peak deviation of 60 kHz.
23. Set the spectrum analyzer for a 200 kHz frequency span/division and a reference level of 0 dBm. Adjust the spectrum analyzer as necessary to display the output signal from the Signal Generator in the center of the display.
24. Connect a power supply to the MODulation INPUT/OUTPUT Connector of the Signal Generator as shown in Figure 3-3. Set the power supply for a +1 Vdc output and switch the voltage line on. Notice the LO EXT annunciator will remain on. The carrier frequency displayed on the Spectrum Analyzer should move three divisions to the right. The carrier frequency is offset by 60 kHz.
25. Press FM, then OFF to turn off the DC FM function.

AM Check

26. Leave the carrier frequency set to 600 MHz, and the output amplitude set to 0.0 dBm. Select AM with a depth of 50% using the internal 400 Hz source.
27. Set the spectrum analyzer to the linear amplitude mode. Set a frequency span/division of zero. Increase the resolution bandwidth, then fine tune for the maximum level of the demodulated signal. The displayed demodulated signal should be a sine wave with a period of 2.5 ms (400 Hz).
28. Press the INT 1 kHz key to change the frequency of the internal modulation source from 400 Hz to 1 kHz. The displayed demodulated signal should be a sine wave with a period of 1 ms (1 kHz).

3-12. HP-IB FUNCTIONAL CHECKS

Description

The following procedures check the Signal Generator's ability to recognize its own HP-IB (listen) address, properly make remote/local transitions, and process all the applicable HP-IB messages described in Table 3-7. During the process, all of the Signal Generator HP-IB data input/output bus, control, and handshake lines are checked, except for DIO8 (the most significant data input/output bus line which is not used by the Signal Generator). Only the Signal Generator, a bus controller, and an HP-IB interface with appropriate cabling are required to perform these procedures. The checks are intended to be as independent of one another as possible, since each begins with the Signal Generator being reset to its initialized condition. Nevertheless, it is suggested that the first four checks be performed in order before any other check. Any special initialization steps or requirements for a given check are provided at the beginning of the check.

The validity of these checks is based on the following assumptions:

- The Signal Generator performs properly when operated via the front-panel keys (that is, in local operation). This can be verified by performing the basic functional checks as outlined in paragraph 3-11.
- The bus controller properly executes HP-IB operations.
- The bus controller's HP-IB interface properly transfers the controller's instructions.
- The select code of the bus controller's interface is set to 7.
- The HP-IB address of the Signal Generator is set to 07 (the factory-set address).
- The select code address combination (that is, 707) is not necessary for these checks to be valid, however, the program lines presented in the following procedures would have to be modified for any other combination.

If the Signal Generator appears to fail any of the remote functional checks, the validity of the preceding assumptions should be confirmed before attempting to service the Signal Generator.

If all of these checks are performed successfully, the Signal Generator HP-IB capability can be considered to be operating properly. These procedures do not check whether or not all of the Signal Generator program codes are being properly interpreted and executed by the Signal Generator, however, if the front-panel operation is confirmed to be working properly and its HP-IB capability operates correctly, then there is a high probability that the Signal Generator will respond properly to all of its program codes.

Initial Setup

The test setup is the same for all of the checks. That is, the Signal Generator is connected to the bus controller through the bus controller's HP-IB interface via the appropriate cable.

Equipment

Use any HP Controller and HP-IB Interface to implement HP-IB functional checks.

Procedure

Address Recognition

This check determines whether or not the Signal Generator recognizes when it is being addressed and when it is not. It is assumed that the Signal Generator is in local operation and that it can properly handshake on the bus. Before beginning this check, verify that the Signal Generator is in local operation and unaddressed by the controller.

Description	BASIC
Set the Remote Enable (REN) bus control line false. Send the listen address to the Signal Generator.	LOCAL 7 OUTPUT 707

1. Verify that the Signal Generator RMT annunciator remains off, and that its ADRS annunciator lights.

Description	BASIC
Unaddress the Signal Generator by sending a different address.	OUTPUT 715

2. Verify that the Signal Generator RMT and ADRS annunciators are both off.

Remote and Local Messages and the LOCAL Key

This check determines whether the Signal Generator properly switches from local to remote operation, switches from remote to local operation, and whether the LOCAL key can return the Signal Generator to local operation. It is assumed that the Signal Generator is able to both handshake and recognize its own address. Before beginning this check verify that the Signal Generator is in local operation and unaddressed by the controller.

Description	BASIC
Send the Remote message which sets the Remote Enable (REN) bus control line true and addresses the Signal Generator to listen.	REMOTE 707

1. Verify that the Signal Generator RMT and ADRS annunciators both light.

Description	BASIC
Send the Local message to the Signal Generator.	LOCAL 707

2. Verify that the Signal Generator RMT annunciator turns off, and that its ADRS annunciator remains on.

Description	BASIC
Send the Local message to the Signal Generator.	REMOTE 707

3. Verify that the Signal Generator RMT and ADRS annunciators are both on. Press the LOCAL key on the front-panel of the Signal Generator and verify that the RMT annunciator turns off, and that the ADRS annunciator remains on.

Data Message

This check determines whether or not the Signal Generator properly receives Data messages. Because the Signal Generator is only a listener, it can only receive Data messages, but never send them. It is assumed that the Signal Generator is able to handshake, recognize its own address, and properly make remote/local transitions. The Data message that is sent will cause the 7 least significant HP-IB data lines to be placed in both their true and false states. Before beginning this check, verify that the Signal Generator is in local operation and unaddressed by the controller.

Description	BASIC
Send first part of the Remote message (enables the Signal Generator remote operating mode).	REMOTE 707
Address the Signal Generator to listen (which completes the Remote message) and send the Data message (which tunes the Signal Generator to 500 MHz).	OUTPUT 707; "FR500MZ"

1. Verify that the Signal Generator RMT and ADRS annunciators both light, and that the FREQUENCY Display shows a carrier frequency of 500.0000 MHz.

Local Lockout and Clear Lockout/Set Local Messages

This check determines whether or not the Signal Generator properly receives the Local Lockout message which disables all of the front-panel keys. In addition, this check determines whether or not the Clear Lockout/Set Local message is properly received and executed by the Signal Generator. It is assumed that the Signal Generator is able to handshake, recognize its own address, and properly make remote/local transitions. Before beginning this check, verify that the Signal Generator is in local operation and unaddressed by the controller.

Description	BASIC
Send first part of the Remote message (enables the Signal Generator remote operating mode).	REMOTE 707
Send the Local Lockout message.	LOCAL LOCKOUT 7
Address Signal Generator to listen (completes the Remote message).	OUTPUT 707

1. Verify that the Signal Generator RMT and ADRS annunciators both light. Press the LOCAL key on the front-panel of the Signal Generator, and verify that its RMT and ADRS annunciators both remain on.

Description	BASIC
Send the Clear Lockout/Set Local Message.	LOCAL 7

2. Verify that the Signal Generator RMT annunciator is turned off, and that its ADRS annunciator remains on.

Clear Message

This check determines whether or not the Signal Generator properly responds to the Clear message. It is assumed that the Signal Generator is able to handshake, recognize its own address, properly make remote/local transitions, and receive Data messages. Before beginning this check, verify that the Signal Generator is in local operation, and unaddressed by the controller.

Description	BASIC
Send first part of the Remote message (enables the Signal Generator remote operating mode).	REMOTE 707
Address the Signal Generator to listen (which completes the Remote message) and send the Data message (which sets the output amplitude of the Signal Generator to 3.0 dB mV).	OUTPUT 707; "APD3DBMV"

1. Verify that the Signal Generator RMT, ADRS, dB, and mV annunciators all light, and that the AMPLITUDE Display shows an output amplitude of 3.0 dBmV.

Description	BASIC
Send the Clear message.	CLEAR 707

2. Verify that the Signal Generator RMT and ADRS annunciators remain on, and that the AMPLITUDE Display now shows frequency as 100 MHz and amplitude as -127.0 dBm (for an HP 8656B) or -143.5 dBm (for an HP 8657A or HP 8657B). The dB and mV annunciators will now be off and the dBm annunciator will be on.

Abort Message

This check determines whether or not the Signal Generator becomes unaddressed when it receives the Abort message. It is assumed that the Signal Generator is able to handshake, recognize its own address, and properly make remote/local transitions. Before beginning this check, verify that the Signal Generator is in local operation and unaddressed by the controller.

Description	BASIC
Send the complete Remote message.	REMOTE 707

1. Verify that the Signal Generator RMT and ADRS annunciators both light.

Description	BASIC
Send the Abort message (which unaddresses the Signal Generator to listen.)	ABORTIO 7

2. Verify that the ADRS and RMT annunciators turn off.



HEWLETT
PACKARD

Quick Reference Guide

HP 8656B/57A/57B Synthesized Signal Generator

COPYRIGHT © 1990 HEWLETT-PACKARD LTD.
SOUTH QUEENSFERRY, SCOTLAND, EH30 9TG



Manual Part Number 08657-90117

0 8 6 5 7 - 9 0 1 1 7

Printed: November 1990

Contents

1. HP 8656B/57A/57B Quick Reference Guide	
General Operating Instructions	1
Power ON Instructions	1
Power STBY Instructions	2
Detailed Operating Instructions	2
Setting Frequency	3
Directions:	3
Comments:	3
Setting Amplitude	4
Directions:	4
Comments:	4
Setting Modulation, AM and FM	5
Directions:	5
Comments:	5
Setting Modulation, Pulse (HP 8657B only)	6
Directions:	7
Comments:	7
Storing/Saving and Recalling Front-Panel Set-Ups	8
Directions for Storing/Saving:	8
Directions for Recalling:	8
Comments:	8
Creating and Recalling Sequences	9
Directions for Creating a Sequence	9
Directions for Recalling a Sequence	9
Directions for Creating a Flexible Sequence	9
Modifying Front-Panel Settings	10
Directions to Modify Modulation:	10
Directions to Modify Frequency:	10
Directions to Modify Amplitude:	10
Comments to Modifying Front-Panel Settings:	11
Miscellaneous Operating Features	12
Directions for Amplitude Offset:	12
Directions to Display a Memory Location:	12
Directions to Display the HP-IB Address:	12
Directions for Frequency Phase Up and Down:	13
Directions to go from HP-IB to Local Control:	13
Directions for Performing an Instrument Preset:	13
Directions to Turn the RF On and Off:	13

HP 8656B/57A/57B Quick Reference Guide

General Operating Instructions

Warning



Before the Signal Generator is switched on, all protective earth terminals, extension cords, autotransformers, and devices connected to it should be connected to a protective earth grounded socket. Any interruption of the protective earth grounding will cause a potential shock hazard that could result in personal injury or loss of life.

For continued protection against fire hazard, replace the line fuse only with a 250V fuse of the same rating. Do not use repaired fuses or short circuited fuse holders.

Caution



Before the Signal Generator is switched on, it must be set to the same line voltage as the power source being used, and a correctly rated line fuse must be fitted.

The Signal Generator is protected against reverse power applications up to 50 watts. However, for maximum protection of expensive internal components, ensure that you do not apply any reverse power to the RF OUTPUT connector.

Power ON Instructions

1. Ensure that the Signal Generator has the correct line voltage selected and that the correct fuse has been installed. (Refer to Section 2)
2. Plug in the power cable. (The Option 001 High Stability Timebase is turned on when the power cable is plugged in.)
3. Press the POWER switch to the ON position. (All front-panel annunciators and LED segments momentarily turn on for a visual inspection.)
4. The Signal Generator is now ready for use.

Power STBY Instructions

Press the POWER switch to the STBY position.

All Signal Generator settings and storage register contents are saved in RAM. When the Signal Generator is turned back ON, the instrument functions last displayed will be active, even if the plug has been disconnected.

Note

If the Signal Generator is switched to STBY with RF ON/OFF set to off, the RF will be turned on when the Signal Generator is turned back ON.

Detailed Operating Instructions

Illustrations in this section of the manual provide you with detailed operating instructions for setting the following Signal Generator features:

- Setting Frequency (page 3-3).
- Setting Amplitude (page 3-4).
- Setting Modulation, AM and FM (page 3-5).
- Setting Modulation, Pulse (HP 8657B only) (page 3-6).
- Storing or Recalling Front-Panel Settings (page 3-8).
- Creating and Recalling Sequences (page 3-9).
- Modifying Front-Panel Settings (page 3-10).
- Miscellaneous Operating Features (page 3-12).

Each illustration is accompanied with directions and comments to provide further information.

Setting Frequency

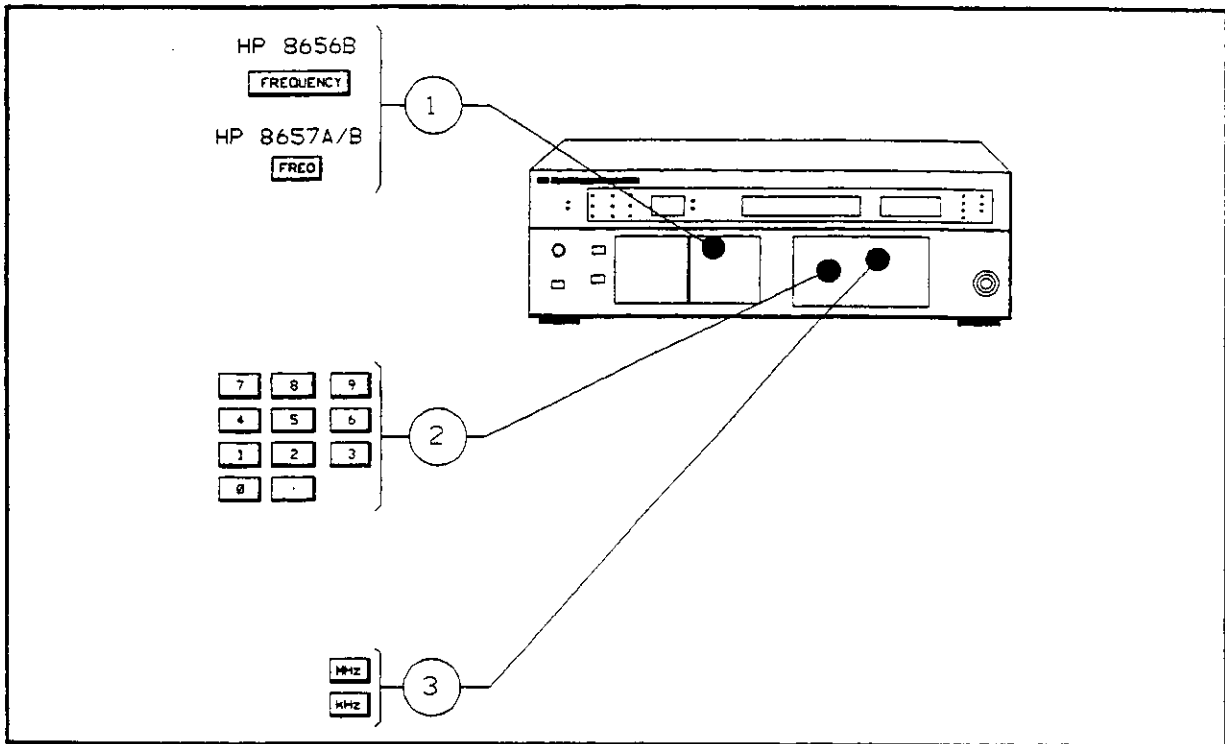

Setting Frequency

Directions:

1. Press the **FREQUENCY** key on the HP 8656B or the **FREQ** key on the 8657A/B.
2. Enter the numeric frequency value.
3. Complete the entry in MHz or kHz.

Comments:

- Skip step 1 (above) for subsequent frequency changes.
- Carrier frequencies below 100 kHz result in an uncalibrated output amplitude.
- The **MODULATION** display flashes if you enter a carrier frequency outside of the Signal Generator's operating limits for the selected FM peak deviation. Change the carrier frequency or the FM peak deviation to correct the error.

Setting Amplitude

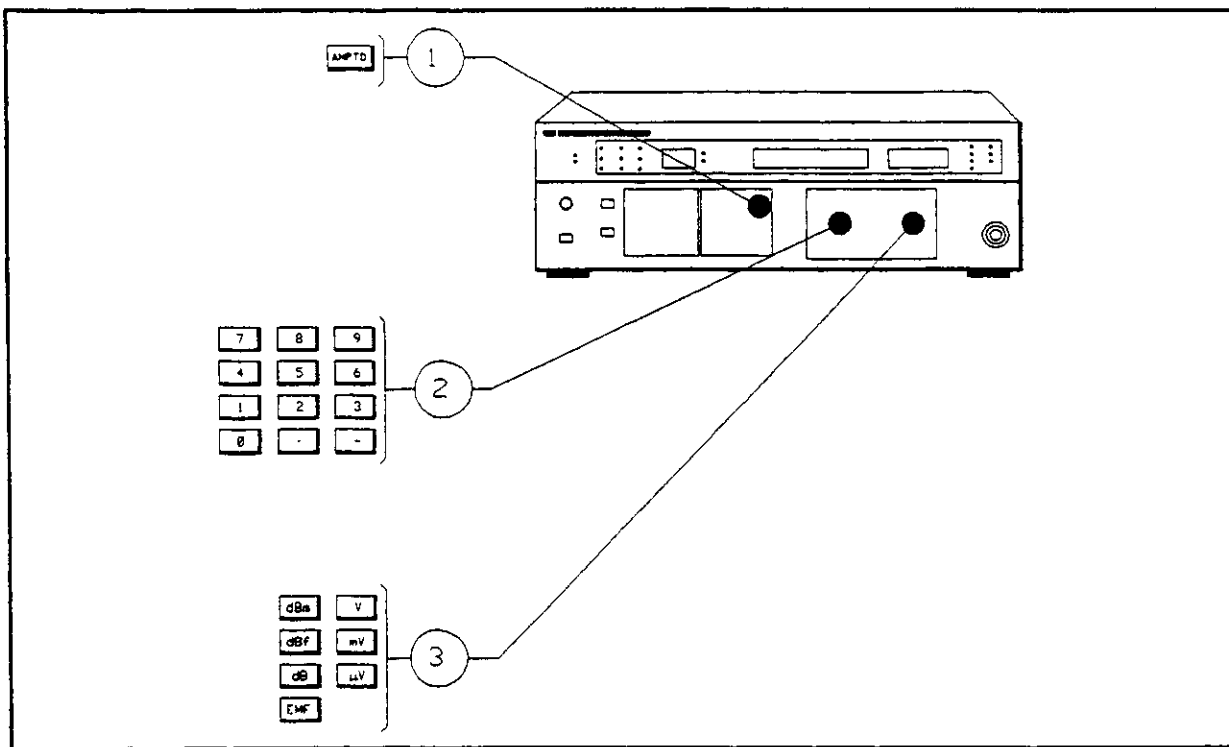

Setting Amplitude

Directions:

1. Press the **AMPTD** key.
2. Enter the numeric amplitude value.
3. Complete the entry in any one of the following 14 entries:

dBm	dB μ V	V	EMF mV
dBf	dB EMF V	mV	EMF μ V
dBV	dB EMF mV	μ V	
dBmV	dB EMF μ V	EMF V	

Comments:

- Minus sign may be entered at any time before completing the entry.
- Digits selected beyond the specified resolution of the **AMPLITUDE** display are truncated.
- Whenever a reverse power condition is detected, the **AMPLITUDE** display and its associated annunciators flash until the source of reverse power is removed and the **AMPTD** key is pressed.

Setting Modulation, AM and FM

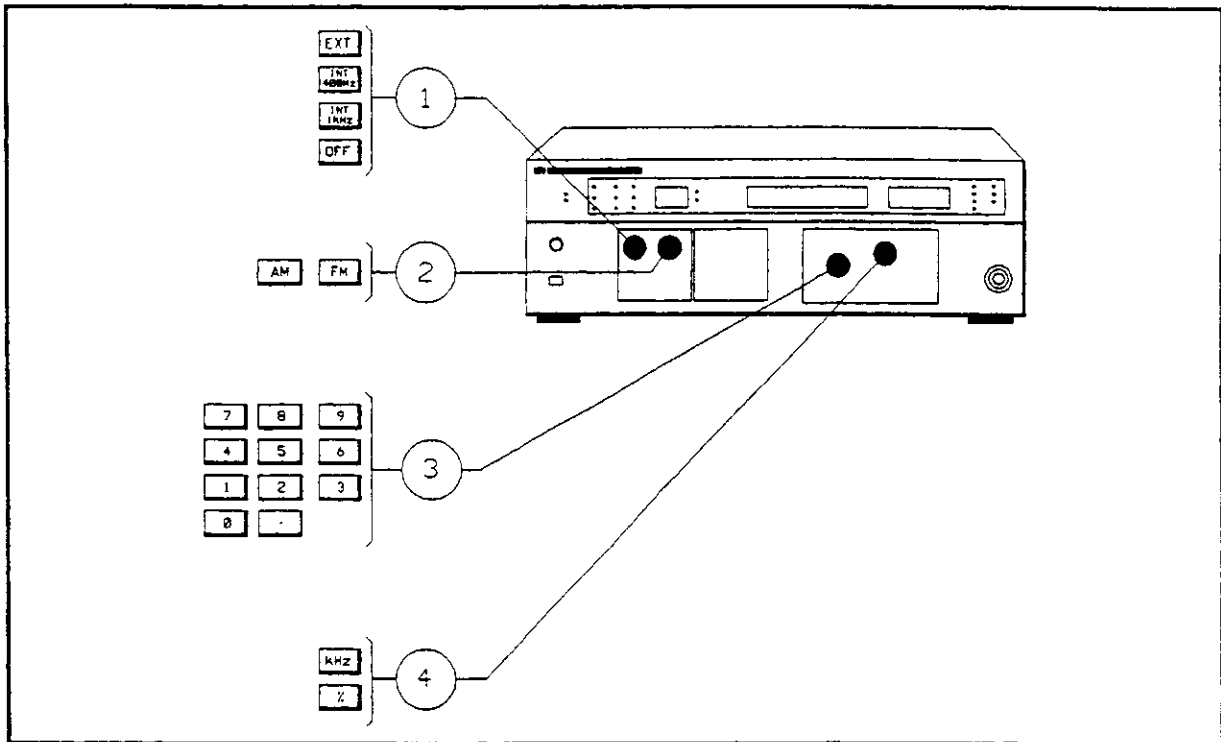

Setting Modulation, AM and FM

Directions:

1. Press one of the **MODULATION SOURCE** keys (for either internal or external source).
2. Press either the **AM** or **FM** key.
3. Enter the numeric modulation depth or deviation value.
4. Complete the entry in percent for AM, or kHz for FM.

(Turn modulation off by first pressing the **AM** or **FM** key, and then the **MODULATION SOURCE OFF** key).

Comments:

- DCFM is turned on by first pressing the blue **SHIFT** key, and then the **FM** key.

Caution

Maximum Allowable input level for DCFM is ± 15 Vdc. Exceeding this limit may cause damage to the Signal Generator.



- Only one internal modulation source can be selected at any time, either 400 Hz or 1 kHz.
- The modulation value is retained when modulation is switched off.

Setting Modulation, Pulse (HP 8657B only)

There are two Pulse modulation modes:

- Pulse modulation (normal mode), and
- Pulse modulation (fast mode).

Use Pulse modulation (normal mode) for:

General purpose bench use.
Testing sensitive loads.

Use Pulse modulation (fast mode) for:

Non-50 Ω loads.
Best level accuracy.
ATE applications to maximize the attenuator's lifespan.

For both Pulse modulation modes, if frequency or amplitude is changed when the carrier frequency is ≥ 1030 MHz, the HP 8657B performs an internal-leveling routine creating a 15 ms (approximately) pulse at the same output level as the RF output.

Based upon the following information about each Pulse modulation mode (normal and fast), decide if the 15 ms internal-leveling pulse should appear at the RF output:

Pulse Modulation (normal mode). This mode switches in all of the attenuator pads to prevent the internal-leveling pulse from appearing at the **RF OUTPUT**. *In high-cycle applications where frequency or amplitude is constantly modified, the attenuator's lifetime may be reduced.*

With Pulse Modulation (normal mode), the internal-leveling routine is calibrated into the attenuator. This means that any impedance mismatch between the load and the attenuator's impedance of 50 Ω , will cause a level difference between the CW RF output and the Pulsed RF output. Typically, for a 50 Ω load, the error will be $< \pm 0.25$ dB.

Note



The impedance mismatch error is only significant for RF output levels $> +3.9$ dBm. Below this level, the HP 8657B's attenuator minimizes the effect of any impedance mismatch.

Pulse Modulation (fast mode). This mode allows the internal-leveling pulse to reach the **RF OUTPUT**. *This mode would present a problem with any device under test that is designed to accept pulses only in the μ s range.*

Caution



The HP 8657B also generates an internal-leveling pulse whenever Pulse modulation (fast mode) is first selected. This happens regardless of the carrier frequency setting. Ensure that the pulse does not cause any damage to the device under test.

With Pulse modulation (fast mode), the internal-leveling routine is calibrated directly into the load. Therefore, the level difference between the CW RF output and the Pulsed RF output is typically $< \pm 0.1$ dB.

Directions:

1. For **Pulse Modulation (normal mode)**, press the blue **SHIFT** key and then the **AM** key.
For **Pulse Modulation (fast mode)**, press the blue **SHIFT** key and then the \uparrow key below the **AM** key.
2. Connect an external modulation source to the **PULSE INPUT** connector. When a pulse waveform from the external modulation source goes high, the Pulse output from the HP 8657B turns on.
3. Vary the external pulse's waveform rate, amplitude, and width to simulate the pulse signal you require.

Caution

The maximum allowable input level for Pulse modulation is ± 15 Vdc. Exceeding this limit may cause damage to the HP 8657B.

Comments:

- Pulse specifications are described Section 1 of the *Operation and Calibration Manual*.
- The **PULSE INPUT** impedance can be selected for 50Ω , or for high impedance. The HP 8657B is set at the factory for high impedance, refer to section 2 of the *Operation and Calibration Manual* if you want to set the input impedance to 50Ω .

Storing/Saving and Recalling Front-Panel Set-Ups

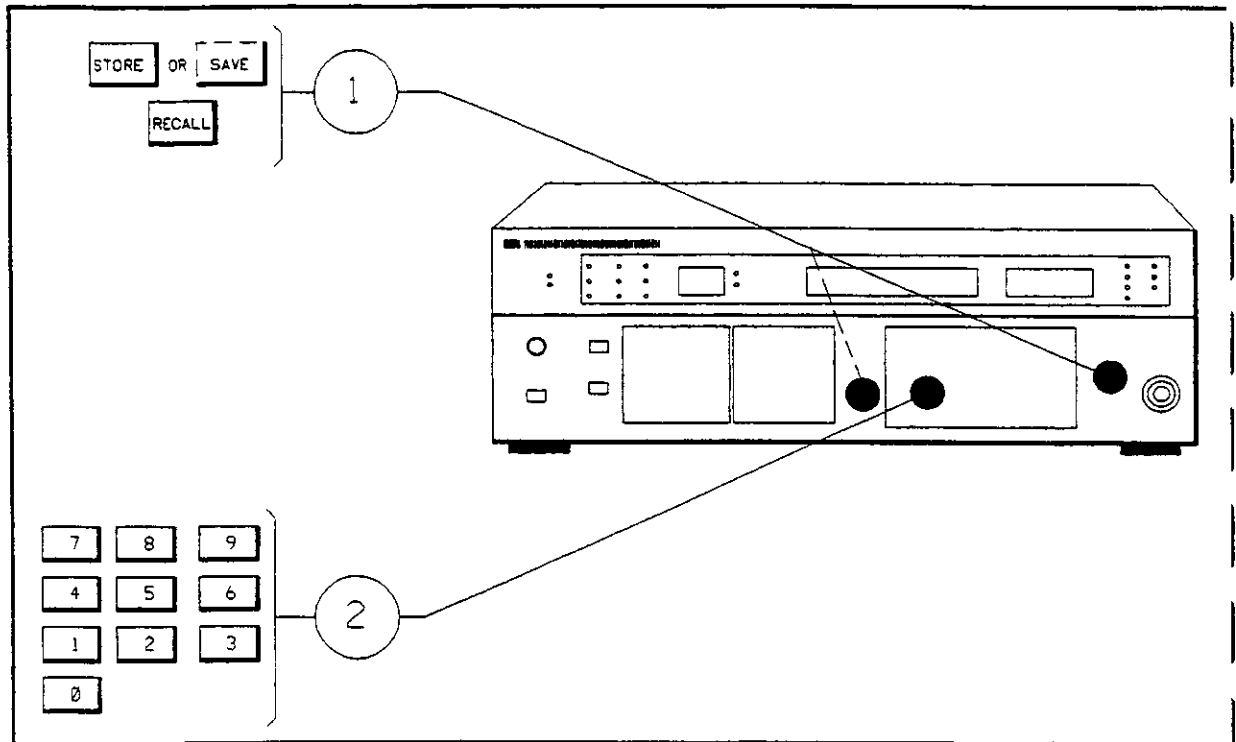

Storing/Saving and Recalling Front-Panel Set-Ups

Directions for Storing/Saving:

1. Set the Signal Generator to the set-up you want to Store/Save
2. Press the **STORE** key (for the HP 8656B) or the **SAVE** key (for the HP 8657A/B).
3. Enter the memory location number (0-99).

Directions for Recalling:

- Press the **RECALL** key.
- Enter the memory location number (0-99).

Comments:

- The Signal Generator has 100 memory locations (0-99), for storing/saving front-panel set-ups (exclusive of increment settings).

Creating and Recalling Sequences

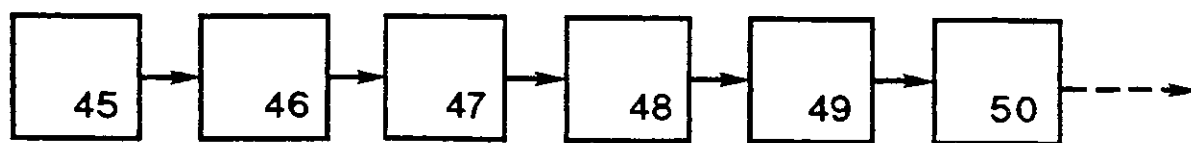

Sequence

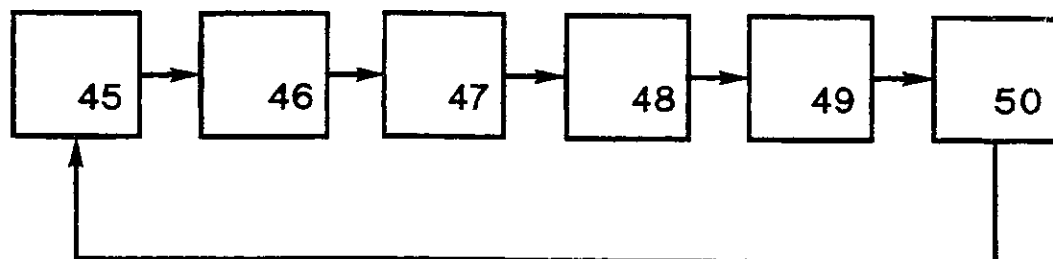

Flexible Sequence

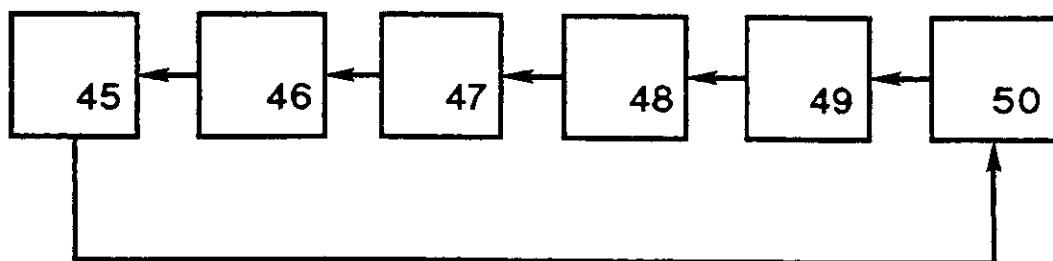

Reverse Sequence

Creating and Recalling Sequences

Directions for Creating a Sequence

1. Set the Signal Generator to the set-up you want.
2. Press the **STORE** key (for the HP 8656B) or the **SAVE** key (for the HP 8657A/B). Enter the memory location number (0-99).
3. Repeat step 1 and 2 until all the set-ups are saved.

Directions for Recalling a Sequence

1. Use the **RECALL** key and the data keys to recall the set-up you want the sequence to start at.
2. Press the **SEQ** key to recall the next set-up.
3. To reverse the sequence, press the **SHIFT**, **SEQ** then the **RECALL** keys.

Directions for Creating a Flexible Sequence

1. Use the the **RECALL** key and the data keys to recall the last set-up in the sequence.
2. Press the **SHIFT** key then four data keys. In the above example the keys would be **5**, **0**, **4** and **5**.

Modifying Front-Panel Settings

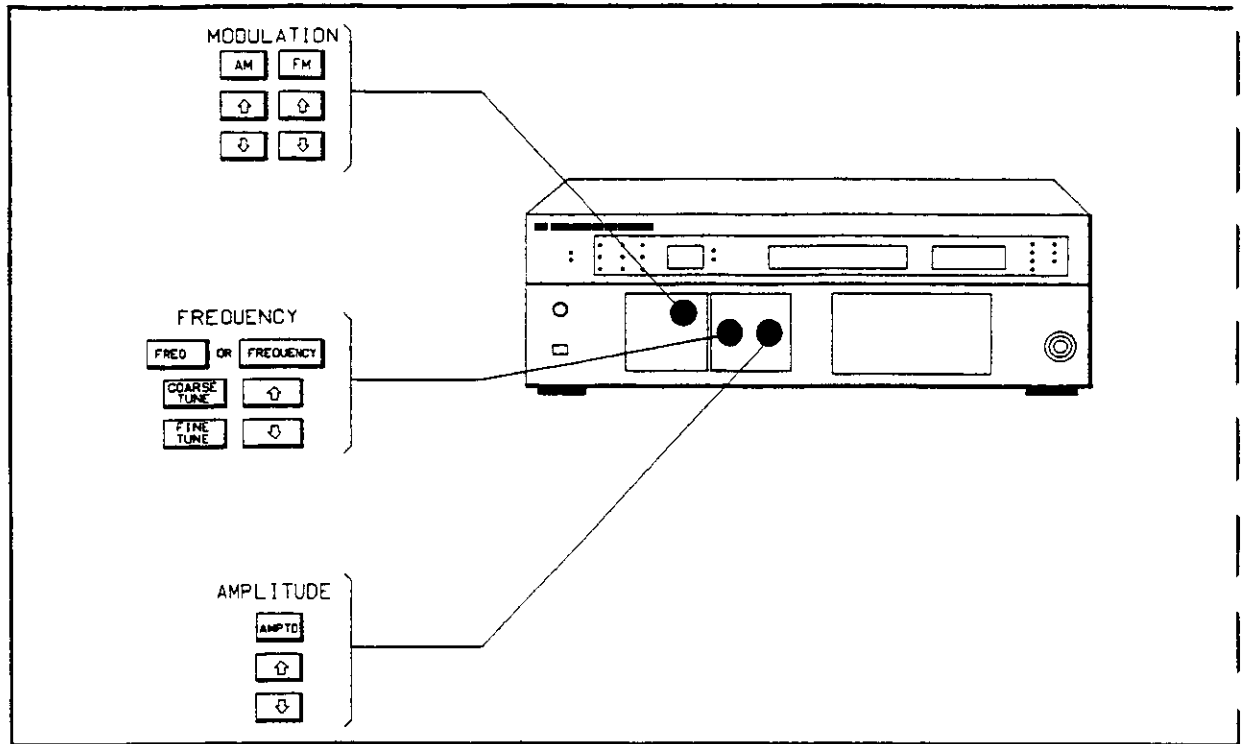

Modifying Front-Panel Settings

Directions to Modify Modulation:

1. Press the **AM** or **FM** key.
2. Press the \uparrow or \downarrow key as many times as needed. The AM depth or FM deviation changes each time you press the \uparrow or \downarrow key by the value in its increment register.

Directions to Modify Frequency:

1. Press the **FREQUENCY** or **FREQ** key (depending upon your Signal Generator).
2. Press the \uparrow or \downarrow key as many times as needed. The frequency changes each time you press the \uparrow or \downarrow key by the value in its increment register.
3. Press the **COARSE TUNE** or **FINE TUNE** key and change the Signal Generator's frequency using the \uparrow or \downarrow keys. (**COARSE TUNE** and **FINE TUNE** value settings are lost when an instrument preset is done.)

Directions to Modify Amplitude:

- Press the **AMPTD** key.
- Press the \uparrow or \downarrow key as many times as needed. The amplitude value of the RF output changes each time you press the \uparrow or \downarrow key by the value in its increment register.

Comments to Modifying Front-Panel Settings:

- Press and hold the **INCR SET** key to view the contents of the increment register. You can modify the contents of the increment register after it has been pressed.
- Increment entries are checked against maximum and minimum allowable increment limits. If a limit is exceeded, the increment entry is either truncated or rejected.
- If the increment register is set to a value that would cause the Signal Generator to exceed its operating range for modulation, frequency, or amplitude, the ↑ and ↓ keys would become inoperative. A correct decrease in the increment setting re-enables the ↑ and ↓ keys.

Miscellaneous Operating Features

The Signal Generator has the following miscellaneous operating features:

- Amplitude offset.
- Display a memory location.
- Display the HP-IB address.
- Frequency phase up and down.
- HP-IB to local.
- Instrument preset.
- RF on and off.

Directions for Amplitude Offset:

The following directions show you how to change the RF output amplitude without altering the valued shown in the AMPLITUDE display.

1. Press the blue **SHIFT** key, and then press the **AMPTD (AP OFS)** key.
2. Enter the numeric amplitude offset value, and then press the **dB** key.
3. You can verify the amplitude offset value by first pressing the blue **SHIFT** key, and then pressing and holding the **AMPTD** key.

Directions to Display a Memory Location:

The following directions show you how to display the contents of any memory location without affecting the actual output of the Signal Generator.

1. Press the blue **SHIFT** key, and then the **SEQ (DSPL)** key.
2. Press the first data key then press and hold the second data key.

Directions to Display the HP-IB Address:

The following directions show you how to display the internally set, decimal HP-IB address.

1. Press the blue **SHIFT** key, and then press and hold the **LOCAL (ADRS)** key.
2. The decimal HP-IB address is shown in the MODULATION display for as long as you hold the **LOCAL (ADRS)** key.

Directions for Frequency Phase Up and Down:

The following directions show you how to change the carrier frequency's phase in one-degree steps, referenced to the internal or external timebase.

1. Press the blue **SHIFT** key, and then either the $\phi\uparrow$ or the $\phi\downarrow$ associated with the **FREQUENCY** key on the HP 8656B or the **FREQ** key on the HP 8657A/B.
2. Holding the $\phi\uparrow$ or $\phi\downarrow$ key down continually changes the carrier frequency in one-degree steps.

Directions to go from HP-IB to Local Control:

Simply press the **LOCAL** key to make the Signal Generator go from HP-IB to local control (that is, front-panel control). You'll notice that the **RMT** annunciator turns off when local control is returned.

Directions for Performing an Instrument Preset:

Simply press the blue **SHIFT** key, and then press the **0 (PRESET)** key. All front-panel annunciators and LED segments will momentarily light up for a visual inspection.

Directions to Turn the RF On and Off:

Simply press the **RF ON/OFF** key to turn the carrier frequency at the **RF OUTPUT** connector on and off.



Section 4

PERFORMANCE TESTS

4-1. INTRODUCTION

The procedures in this section test the Signal Generator electrical performance using the specification tables in Section 1 as the performance standards. All tests can be performed without access to the interior of the instrument. A simpler operational test is included in Section 3 under User Confidence Tests.

NOTE

If the performance tests are to be considered valid, the following conditions must be met:

- a. The Signal Generator must have a 30-minute warmup.*
- b. The line voltage must be 100, 120, 220, or 240 Vac (+5%, -10%) from 48 to 440 Hz. The Voltage Selector Cam must be in the proper position. Refer to Figure 2-1.*
- c. The ambient temperature must be 0 to 55° C for the Level Accuracy and Flatness Test.*

4-2. EQUIPMENT REQUIRED

Equipment required for the performance tests is listed in Table 1-4, Recommended Test Equipment. Any equipment that satisfies the critical specifications given in the table may be substituted for the recommended model(s).

4-3. PERFORMANCE TEST RECORD

You can record the results of the performance tests in the Performance Test Record, located at the end of this section. The Test Record lists all of the tested specifications and their acceptable limits. The results recorded at incoming inspection can be used for comparison in periodic maintenance and troubleshooting and after repairs or adjustments.

4-4. CALIBRATION CYCLE

The Signal Generator requires periodic verification of performance. Depending on the use and environmental conditions, the Signal Generator should be checked using the following performance tests at least once each year.

4-5. ABBREVIATED PERFORMANCE TESTING

In most cases, it is not necessary to perform all of the tests in this section. Table 4-1a and Table 4-1b show which tests are recommended for various situations. The User Confidence Tests in Section 3 should be the first step in all testing situations.

4-6. TEST PROCEDURES

It is assumed that if you are performing the following tests, that you know how to operate the specified test equipment. Equipment settings, other than those for the Signal Generator, are stated in general terms. For example, a test might require that a spectrum analyzer's resolution bandwidth be set to 100 Hz; however, the time per division setting would not be specified and you would set that control so that the analyzer operates correctly.

It is also assumed that you will supply whatever cables, connectors, and adapters are necessary.

Table 4-1a. Abbreviated Performance Tests for HP 8656B and HP 8657A

Testing Situations	Section 3 Confidence Tests		Performance Test Number and Name				
	Basic	HP-IB	1	2	3	4	5
			Spectral Purity	Output Level Accuracy And Flatness	Modulation	Output Leakage	SWR
Incoming Inspection or Overall Performance Verification	X	X	X	X	X	X	X
After Complete Adjustment	X		X	X	X	X	X
After Repairs to Assembly:							
A1	X						
A2	X						
A3A1	X		X		FM		
A3	X		X		FM		
A3	X		X				
A3	X		X		FM		
A3	X		X		FM		
A3	X		X		FM		
A3	X		X				
A4	X		X				
A4	X		X				
A6	X		X	X	AM		
A6	X		X	X			
A8	X		X				
A9	X		X	X		X	X
A10	X						
A11	X			X	X		
A15	X						
A16	X						
FL1	X		X				

Table 4-1b. Abbreviated Performance Tests for HP 8657B

Testing Situations	Section 3 Confidence Tests		Performance Test Number and Name				
	Basic	HP-IB	1	2	3	4	5
			Spectral Purity	Output Level Accuracy And Flatness	Modulation	Output Leakage	SWR
Incoming Inspection or Overall Performance Verification	X	X	X	X	X	X	X
After Complete Adjustment	X		X	X	X	X	X
After Repairs to Assembly:							
A1	X						
A2	X						
A3A1	X		X		FM		
A3	X						
A3	X		X		FM		
A3	X		X				
A3	X		X		FM		
A3	X		X		FM		
A3	X		X		FM		
A3	X		X				
A4	X		X				
A4	X		X				
A6	X		X	X	AM		
A6	X		X	X			
A8	X		X				
A10	X		X	X	PULSE		X
A11	X				AM/FM		
A12	X		X	X	X		X
A13	X	X		X	X		
A14	X						
A15	X						
A16	X						
FL1	X		X				

Performance Test 1

SPECTRAL PURITY TESTS

- Spurious Signals
- Residual AM
- Residual FM
- SSB Phase Noise (1 Hz Bandwidth)

HP 8656B Specifications

Electrical Characteristics	Performance Limits	Conditions
Spurious Signals:		
Harmonics	< -30 dBc	≤ +7 dBm output levels 0.1 to 990 MHz
Non-harmonics	< -60 dBc	> 5 kHz from carrier in CW mode 0.1 to 990 MHz
Sub-harmonics	None	
Residual Modulation CW Mode:		
AM	- 30 dBc	0.1 to 990 MHz
(0.5 to 15 kHz Post Detection Noise Bandwidth)		
FM	< 7 Hz rms	0.1 to 123.5 MHz
(0.3 to 3 kHz Post Detection Noise Bandwidth)	< 2 Hz rms	123.5 to 247 MHz
	< 4 Hz rms	247 to 494 MHz
	< 7 Hz rms	494 to 990 MHz
FM	< 15 Hz rms	0.1 to 123.5 MHz
(0.05 to 15 kHz Post Detection Noise Bandwidth)	< 4 Hz rms	123.5 to 247 MHz
	< 8 Hz rms	247 to 494 MHz
	< 15 Hz rms	494 to 990 MHz
SSB Phase Noise		20 kHz offset from carrier
	< -114 dBc/Hz	0.1 to 123.5 MHz
	< -126 dBc/Hz	123.5 to 247 MHz
	< -120 dBc/Hz	247 to 494 MHz
	< -114 dBc/Hz	494 to 990 MHz

HP 8657A Specifications

Electrical Characteristics	Performance Limits	Conditions
Spurious Signals: Harmonics	< -30 dBc	$\leq +7$ dBm output levels 0.1 to 1040 MHz
Non-harmonics		> 5 kHz to 2 MHz from carrier in CW mode
Sub-harmonics	< -60 dBc	0.1 to 130 MHz
	< -72 dBc	130 to 260 MHz
	< -66 dBc	260 to 520 MHz
	< -60 dBc	520 to 1040 MHz
None	< 0.04%	0.1 to 1040 MHz
Residual Modulation CW Mode:		
AM		
(0.5 to 15 kHz Post Detection Noise Bandwidth)		
FM	< 4 Hz rms	0.1 to 130 MHz
(0.3 to 3 kHz Post Detection Noise Bandwidth)	< 1 Hz rms	130 to 260 MHz
	< 2 Hz rms	260 to 520 MHz
	< 4 Hz rms	520 to 1040 MHz
FM	< 6 Hz rms	0.1 to 130 MHz
(0.05 to 15 kHz Post Detection Noise Bandwidth)	< 1.5 Hz rms	130 to 260 MHz
	< 3 Hz rms	260 to 520 MHz
	< 6 Hz rms	520 to 1040 MHz
SSB Phase Noise	< -124 dBc/Hz	20 kHz offset from carrier
	< -136 dBc/Hz	0.1 to 130 MHz
	< -130 dBc/Hz	130 to 260 MHz
	< -124 dBc/Hz	260 to 520 MHz
	< -124 dBc/Hz	520 to 1040 MHz

HP 8657B Specifications

Electrical Characteristics	Performance Limits	Conditions
Spurious Signals:		
Harmonics	< -30 dBc	≤ +7 dBm output levels 0.1 to 1030 MHz
	< -25 dBc	1030 to 2060 MHz
Non-harmonics		> 5 kHz to 2 MHz from carrier in CW mode
	< -63 dBc	0.1 to 130 MHz
	< -75 dBc	130 to 260 MHz
	< -66 dBc	260 to 520 MHz
	< -63 dBc	520 to 1030 MHz
	< -57 dBc	1030 to 2060 MHz
	< -60 dBc	≥ 2 MHz from carrier in CW mode 0.1 to 1030 MHz
	< -54 dBc	1030 to 2060 MHz
Sub-harmonics	None	0.1 to 1030 MHz
	< -40 dBc	1030 to 1800 MHz
	< -35 dBc	1800 to 2060 MHz
Residual Modulation CW Mode:		
AM	< 0.04%	0.1 to 2060 MHz
(0.5 to 15 kHz Post Detection Noise Bandwidth)		
FM	< 4 Hz rms	0.1 to 130 MHz
(0.3 to 3 kHz Post Detection Noise Bandwidth)	< 1 Hz rms	130 to 260 MHz
	< 2 Hz rms	260 to 520 MHz
	< 3 Hz rms	520 to 1040 MHz
	< 6 Hz rms	1040 to 2060 MHz
FM	< 6 Hz rms	0.1 to 130 MHz
(0.05 to 15 kHz Post Detection Noise Bandwidth)	< 1.5 Hz rms	130 to 260 MHz
	< 3 Hz rms	260 to 520 MHz
	< 4 Hz rms	520 to 1040 MHz
	< 8 Hz rms	1040 to 2060 MHz
SSB Phase Noise		20 kHz offset from carrier
	< -124 dBc/Hz	0.1 to 130 MHz
	< -136 dBc/Hz	130 to 260 MHz
	< -130 dBc/Hz	260 to 520 MHz
	< -124 dBc/Hz	520 to 1040 MHz
	< -118 dBc/Hz	1040 to 2060 MHz

Description

Spurious signals are checked using a spectrum analyzer. Residual AM and FM Modulation are checked to 1300 MHz using a measuring receiver. SSB phase noise of the HP 8657A and HP 8657B is measured to 1600 MHz using a phase noise measurement system. SSB phase noise of the HP 8656B is measured by mixing the RF output of the Signal Generator and a Reference Signal in a double balanced mixer to eliminate the carrier and translate the noise spectrum to a low frequency where it can be viewed on a spectrum analyser. The output of the mixer is viewed on a spectrum analyser.

Equipment

Spectrum Analyzer	HP 8562B or HP 8555A/8552B/141T (Harmonics/Spurious Tests)
Measuring Receiver	HP 8902A (Option 003 for Optional Residual FM Tests)
Sensor Module	HP 11722A
Digital Multimeter	HP 3466A
Oscilloscope	HP 54501A
AM/FM Test Source	HP 11715A
Cable (UG-21D/U type N connectors)	HP 11500B
Cable (UG-88C/U BNC and dual banana plug connectors)	HP 11001-60001
Synthesized Signal Generator/(LO for Optional Residual FM Test)	HP 8662A
Phase Noise Measurement System	HP 3048A

Procedure

Spurious Signals Test

1. Set the spectrum analyzer as follows:

Center Frequency	100 kHz
Frequency Span	30 kHz
Resolution Bandwidth	300 Hz
Reference Level	+7 dBm

2. Set the Signal Generator as follows:

Frequency	100 kHz
Frequency Increment	100 kHz
Amplitude	+7 dBm
Modulation	Off

NOTE

The Reference Level of both the Signal Generator and the Spectrum Analyser should be +4 dBm if the HP 8657B you are using is fitted with Pulse Modulation. Pulse Modulation is available as an option on the HP 8657B only.

3. Connect the RF OUTPUT of the Signal Generator to the input of the spectrum analyzer as shown in Figure 4-1. Verify that all harmonics are within the specifications shown in the following table.

Spurious Signals	Results			
	Actual	HP 8656B	HP 8657A	HP 8657B
Harmonics	_____	< -30 dBc	< -30 dBc	< -30 dBc (0.1 to 1030MHz) < -25 dBc (1030 to 2060MHz)
Non-Harmonics (≥ 2 MHz from carrier)	_____	< -60 dBc	< -60 dBc	< -60 dBc (0.1 to 1030MHz) < -54 dBc (1030 to 2060 MH)
5 kHz to 2 MHz from carrier	_____	< -60 dBc	< -60 dBc (0.1 to 130MHz)	< -63 dBc (0.1 to 130MHz)
	_____		< -72 dBc (130 to 260MHz)	< -75 dBc (130 to 260MHz)
	_____		< -66 dBc (260 to 520MHz)	< -66 dBc (260 to 520MHz)
	_____		< -60 dBc, 520 to 1040MHz	< -63 dBc (520 to 1030MHz)
	_____			< -57 dBc (1030 to 2060 MH)
Sub-Harmonics	_____	None	None	None, 0.1 to 1030 MHz < -40 dBc (1030 to 1800 MH. < -35 dBc (1800 to 2060 MH.

NOTE

Adjust the Center Frequency, Frequency Span, and Resolution Bandwidth controls as required.

Change the frequency increment from 100 kHz to 10 MHz at 10 MHz, if desired.

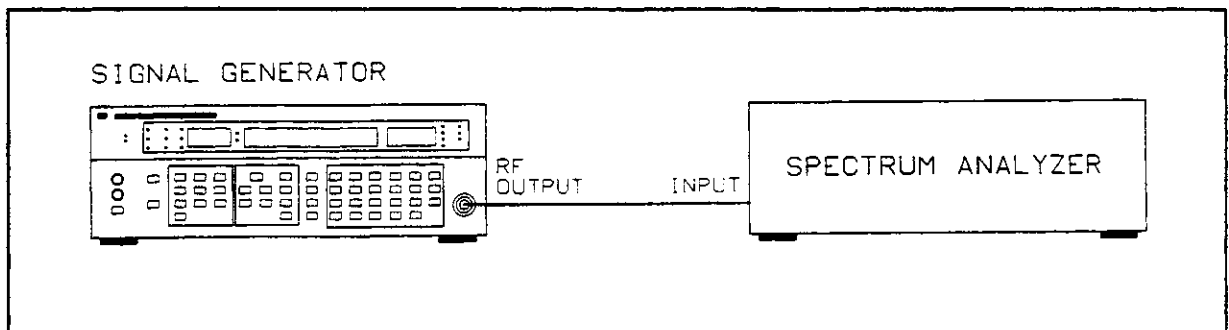

Figure 4-1. Spurious Signals Test Setup

Residual AM

4. Verify the residual AM of the measuring receiver as follows:

- a. Connect the modulation output of the measuring receiver to the input of the digital multimeter and the AM output of the AM/FM test source to the input of the measuring receiver as shown in Figure 4-2. Nothing should be connected to the audio input of the AM/FM test source.

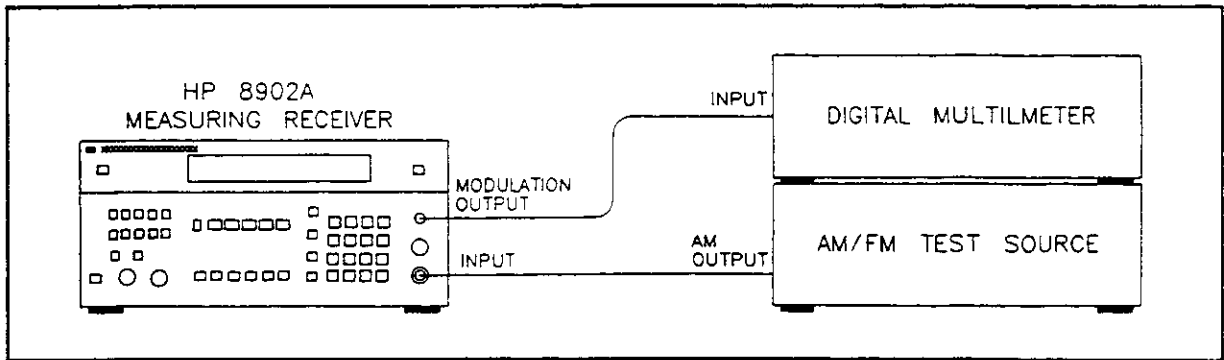

Figure 4–2. Measuring Receiver Residual AM Verification Test Setup

NOTE

The residual AM specification of the Signal Generator is not equivalent to the published specification of the HP 8902A Measuring Receiver. To make a valid residual AM measurement, the residual AM of the measuring receiver should be at least 3 dB better than the specification being tested. The residual AM of the Measuring Receiver must be verified to be adequate to measure the Signal Generator residual AM specification to ensure the validity of the measurement. If residual AM is measured frequently, it is not necessary to verify the residual AM of the measuring receiver each time; however, it is recommended that it be verified monthly to ensure an accurate measurement.

- b. Set the measuring receiver as follows:
 Measurement Frequency
- c. Set the AM/FM test source as follows:
 Test Mode FM
- d. Tune the carrier frequency on the AM/FM test source for a measuring receiver reading of 12.5 ±0.1 MHz.
- e. Set the digital multimeter as follows:
 Function Vac
 Range 200 mV
- f. Set the measuring receiver as follows:
 Measurement AM
 HP Filter 50 Hz
 LP Filter 15 kHz
- g. The digital multimeter should indicate 1.77 mV or less for an HP 8656B and 3.28 mV or less for an HP 8657A or HP 8657B.

NOTE

To make a valid residual AM measurement, the residual AM of the measuring receiver should be at least 3 dB better than the specification being tested.

5. Set the measuring receiver as follows:

- Measurement AM
- Detector Peak+
- HP Filter 50 Hz
- LP Filter 15 kHz
- FM De-Emphasis Off

6. Set the Signal Generator as follows:

- Frequency Any
- Amplitude 0.0 dBm
- Modulation Off

7. Set the digital multimeter as follows:

- Function Vac
- Range 200 mV

8. Connect the RF OUTPUT of the Signal Generator to the input of the measuring receiver and the modulation output of the measuring receiver to the input of the digital multimeter as shown in Figure 4-3.

9. The digital multimeter should indicate <1.77 mVrms for an HP 8656B and <3.28 mVrms for an HP 8657A or HP 8657B.

Actual	Maximum
_____	< 1.77 mVrms
_____	< 3.28 mVrms

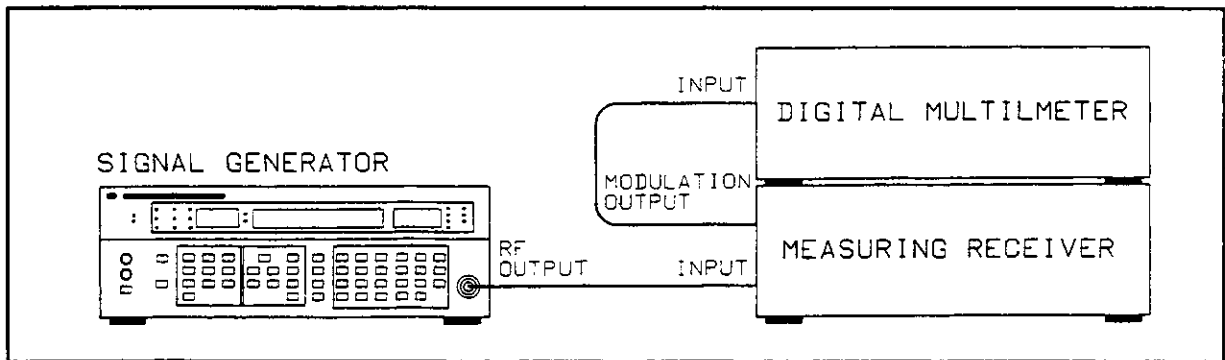

Figure 4-3. Residual AM Test Setup

Residual FM

NOTE

A standard HP 8902A can be used to verify the residual FM specifications in the heterodyne band of frequencies. Tests performed at these frequencies will verify that in all probability, the instrument meets its specifications. If the Signal Generator has been repaired or the heterodyne band of frequencies do not pass, the Optional Residual FM Test (steps 14-18) should be performed.

10. Set the measuring receiver as follows:

- Measurement FM
- Detector RMS
- FM De-Emphasis Off
- Automatic Operation Selected

11. Set the Signal Generator under test as follows:

- Frequency Any From Chart
- Amplitude 0.0 dBm
- Modulation Off

12. Connect the RF OUTPUT of the Signal Generator under test to the input of the measuring receiver as shown in Figure 4-4.

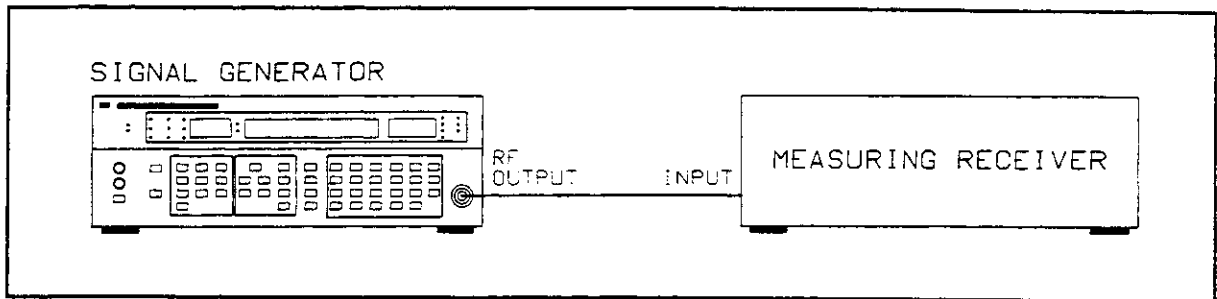

Figure 4-4. Residual FM Test Setup

13. Set the Signal Generator frequency and select the measuring receiver high-pass and low-pass filters as indicated in the following table. Verify that the measured results do not exceed the limits specified.

Signal Generator Frequency (MHz)	Modulation Analyzer Filter		Results (Hz rms)	
	High Pass (Hz)	Low Pass (kHz)	Actual	Max.
0.15 to 123.00000	300	3	_____	< 4
0.15 to 123.00000	50	15	_____	< 6

Optional Residual FM Test

The Residual FM Test gives confidence that the Signal Generator is passing all its Residual FM specifications. The Residual FM of the Signal Generator can be checked at all frequencies to 1300 MHz with an HP 8902A Option 003 and an external local oscillator (LO). The residual FM of the external LO must be less than the residual FM of the Signal Generator under test.

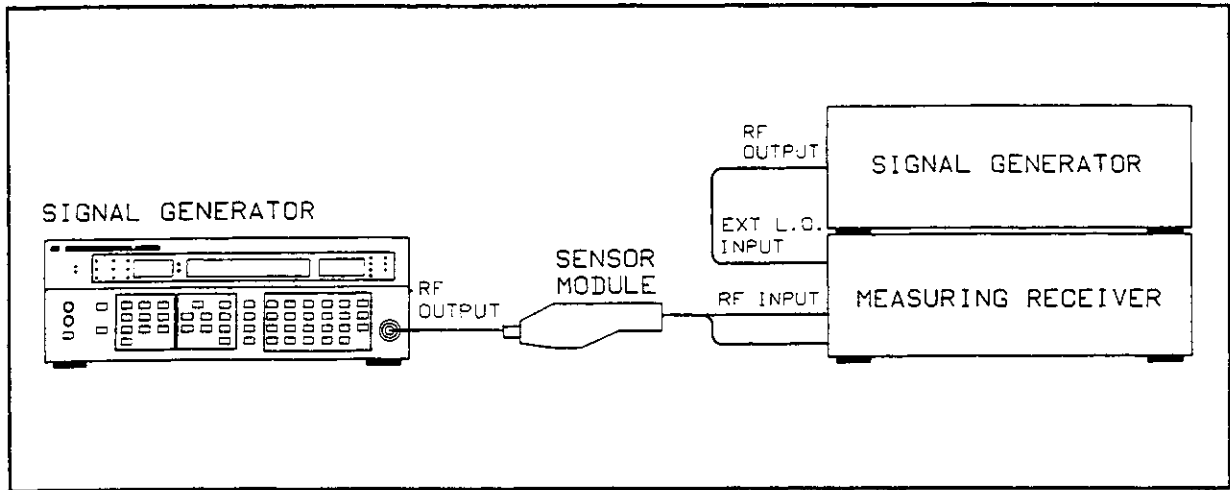

Figure 4-5. Optional Residual Test Setup

14. Set the measuring receiver as follows:

Measurement FM
 Detector RMS
 FM De-Emphasis Off
 Automatic Operation Selected

15. Set the Signal Generator under test and the LO Signal Generator as follows:

Frequency Any From Chart
 Amplitude 0.0 dBm
 Modulation Off

16. Connect the test equipment as shown in Figure 4-5.

17. Set frequency on the Test Signal Generator and the LO Signal Generator as is shown in the following table. Select the measuring receiver high-pass filter for 300 Hz and the low-pass filter for 3 kHz. Verify that the measured results do not exceed the limits specified.

Optional Residual FM Test Specifications

Test Signal Generator Frequency (MHz)	LO Signal Generator Frequency (MHz)	Results (Hz rms)					
		HP 8656B		HP 8657A		HP 8657B	
		Actual	Max	Actual	Max	Actual	Max
120	121.5	—	7	—	4	—	4
150	151.5	—	2	—	1	—	1
300	301.5	—	4	—	2	—	2
600	601.5	—	7	—	4	—	3
1300	1301.5	N/A	N/A	N/A	N/A	—	6

18. Set frequency on the Test Signal Generator and the LO Signal Generator as is shown in the following table. Select the measuring receiver high-pass filter for 50 Hz and the low-pass filter for 15 kHz. Verify that the measured results do not exceed the limits specified.

Optional Residual FM Test Specifications

Test Signal Generator Frequency (MHz)	LO Signal Generator Frequency (MHz)	Results (Hz rms)					
		HP 8656B		HP 8657A		HP 8657B	
		Actual	Max	Actual	Max	Actual	Max
120	121.5	_____	15	_____	6	_____	6
150	151.5	_____	4	_____	1.5	_____	1.5
300	301.5	_____	8	_____	3	_____	3
600	601.5	_____	15	_____	6	_____	4
1300	1301.5	N/A	N/A	N/A	N/A	_____	8

HP 8656B SSB PHASE NOISE (1 HZ BANDWIDTH)

Description

SSB phase noise is measured at Signal Generator RF Output frequencies from 200 KHz to 500 MHz (frequency range of the mixer) by mixing RF output and a reference in a double balanced mixer. The RF OUTPUT reference is set in quadrature (90° apart) so the mixer output is a dc component, and a high frequency component. The high frequency component is filtered out leaving the dc, which is proportional to the phase noise. The Signal Generator frequency is offset from the reference frequency by 20 KHz to set a reference on the spectrum analyzer. The Signal Generator frequency is then set to the reference frequency and amplitude to 0 dBm. The SSB phase noise is measured at the 20 KHz offset.

NOTE

This test measures the total SSB Phase Noise of both Generators. Therefore, the reference generator must have SSB Phase Noise less than or equal to the specifications for the Generator under test.

1. Connect the equipment as shown in figure 4-6.

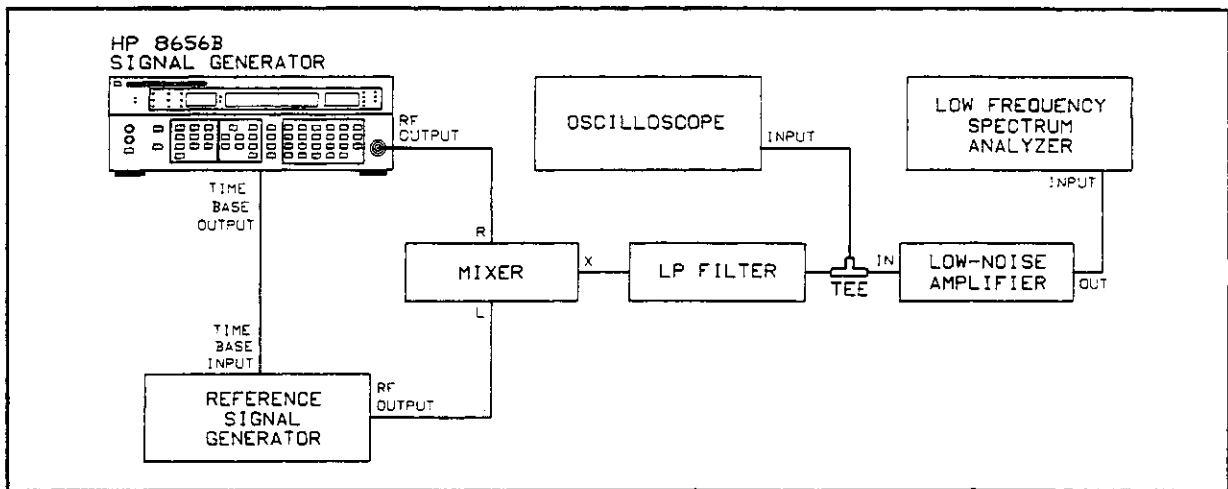

Figure 4-6. HP 8656B SSB Phase Noise Measurement Set-up

NOTE

The following symbols are used in the procedure.

f_{RF} = the RF output frequency where SSB phase noise will be measured.

f_{off} = the frequency offset from f_{RF} where SSB phase noise will be measured.

2. Set the reference generator frequency to f_{RF} and output level to +13 dBm. Set the Signal Generator under test to $f_{RF} + f_{off}$ and output level to -50 dBm.
3. On the 8568A spectrum analyzer, set the REFERENCE LEVEL to -20 dBm, FREQUENCY SPAN to 1 kHz and view the signal at f_{off} .
4. Set the 8568A spectrum analyzer's reference level so the signal is 9 dB below the spectrum analyzer reference (-6 dB converts measured reading to SSB phase noise and -3 dB corrects for equal SSB phase noise RF sources).
5. Set the Signal Generator under test to f_{RF} and 0 dBm output Amplitude.
6. Set the frequency increment of the Signal Generator under test to 10 Hz.
7. Set the oscilloscope as follows:

INPUT	CHAN A
VOLTS/DIV	0.1, dc
DISPLAY	CHAN A
TRIGGER	CHAN A
TIME/DIV	10 mSEC
8. Press the Signal Generator frequency Increment UP key and view the signal on the oscilloscope. The signal is a low frequency signal moving around ground level. Stop the signal at ground level (within 50 mV of ground) by pressing the frequency Increment DOWN key. The key sequence to increment the frequency UP and DOWN may have to be executed several times to stop the signal within 50 mV of ground. This sets the two input signals to the mixer in phase quadrature.
9. Set the spectrum analyzer to measure SSB Phase Noise in a 1 Hz bandwidth, select SHIFT (M) NORMAL keys, and to Video Averaging, select SHIFT (G) VIDEO BW, 1, 2, Hz keys.
10. The SSB Phase Noise is read directly from the spectrum analyzer display, -XXX dB in 1 Hz bandwidth plus the following correction:
 - a. Take the difference between -50 dB and the spectrum analyzer reference.
 - b. Add this difference to the spectrum analyzer -XXX dB in 1 Hz bandwidth to correct for the change in the attenuator setting of the Signal Generator under test.
11. Measured SSB Phase Noise should be at or below the specified value.

Offset from Carrier	HP 8656B SSB Phase Noise		Carrier Frequency (MHz)
	Min.	Actual	
20 kHz	-114 dBc/Hz	_____	0.1 to 123.5
	-126 dBc/Hz	_____	123.5 to 247
	-120 dBc/Hz	_____	247 to 494
	-114 dBc/Hz	_____	494 to 990

HP 8657A/57B SSB PHASE NOISE (1 HZ BANDWIDTH)**NOTE**

This method of measuring Phase Noise is to be used on the HP 8657A or HP 8657B only.

Description

Single-sideband (SSB) phase noise of the Signal Generator is measured at the offset frequency of 20 KHz and output frequencies to 1600 MHz by the HP 3048A Phase Noise System using its Phase Lock Loop measurement type. The system software provides both the measurement program and the BASIC operating system for the controller. This procedure provides the steps for entering the specific measurement parameters required for this test.

NOTE

This test measures the total SSB phase noise of both generators. This test assumes that the noise level of the reference source you are using is lower than or equal to the noise level of the Signal Generator being tested. If the reference source's phase noise level is equal to the Signal Generator's, the actual noise level for both sources is 3 dB below the level measured by the HP 3048A.

1. The HP 3048's BASIC operating system and system software must be loaded, the Signal Generator's HP-IB address entered, and system operation verified before this test is run. Refer to the HP 3048A Phase Noise Measurement System Operating Manual, Appendix A for the required procedures.
2. If you are not at the HP 3048A's Main Software Level, press the **Done** or **Abort** Softkey. The Main Software Level menu provides access to each of the HP 3048's main functions. You will always return to this menu when you exit the selected function.

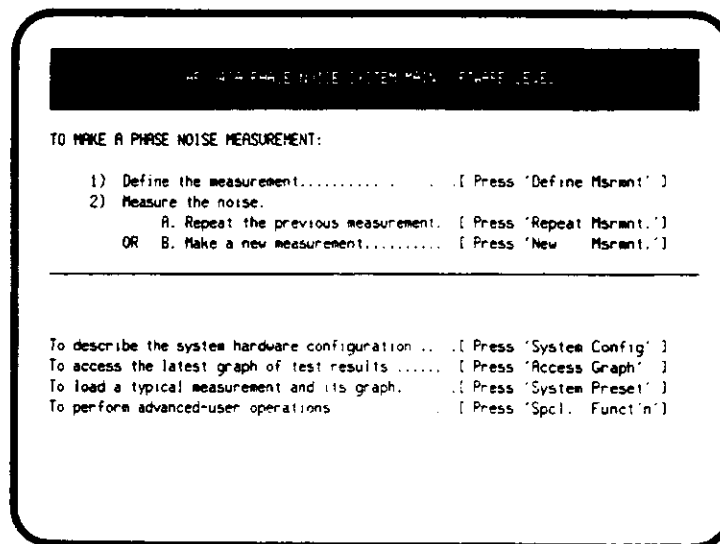
**Defining the Measurement**

3. Press the **Define Msrmt** Softkey to display the Measurement Definition Menu.
4. Press the **Test Files** softkey.
5. Position the cursor at the file labeled HP EXAMPLE RF SYNTHESIZER (8662/3 DCFM).
6. Press the **Load File** key. After the HP 3048A has completed the file loading sequence, press the **Done** key.

NOTE

This example file contains many of the measurement parameters required for this test. Table 4-2 lists the parameters that have been loaded from this file. The following steps will guide you through the process of making the necessary changes to the parameters to meet the specific requirements of this test.

7. Press the **Instr Params** key. Enter a carrier frequency of 640 E+6 Hz. Enter a Detector/Disc. Input frequency of 640 E+6 Hz. Enter a VCO Tuning Constant of 1 E+3 Hz/volt. Enter the Voltage Tuning Range of VCO as 5 volts. The remaining entries do not need to be changed. Press the **Done** key.
8. Press the **Calibr Process** key. Press the **Tuning Const** key to select Compute from expected T. Constant. Press the **Done** key.
9. Press the **Source Control** key. Press the **Ref. Source** key as needed to select 8657B SYSTEM CNTRL. Press the **Done** key when you have completed this operation.

NOTE

*The Signal Generator under test is configured as the reference source in this display to enable the HP 3048A to control it using control routines built into the HP 3048A's software. The measurement results will still reflect the noise level of the Signal Generator under test. If you are not able to select the Signal Generator as the reference source using the Ref. Source key, then the Signal Generator has not yet been entered into the HP 3048A's Configuration Table. To enter the Signal Generator, return to the Main Software Menu and press the **System Config** key.*

10. Press the **Define Graph** key. Enter an appropriate graph title for your test. Press the **Done** key to exit this menu, and then press the **Done** key again to return to the Main Software level.

Beginning the Measurement

11. Press the **New Msrmt** key to begin the phase noise measurement.
12. When the hardware connect diagram appears in the display, connect the Signal Generator and reference source to the HP 3048A as shown. (Note that the reference source is labeled USERS's DUT on the screen. Figure 4-7 also shows the cable connections for this measurement.)
13. Adjust the reference source's center frequency to 640 MHz and its amplitude to 0 dBm. (The Signal Generator's setting will be adjusted by the HP 3048A via its HP-IB connection.)

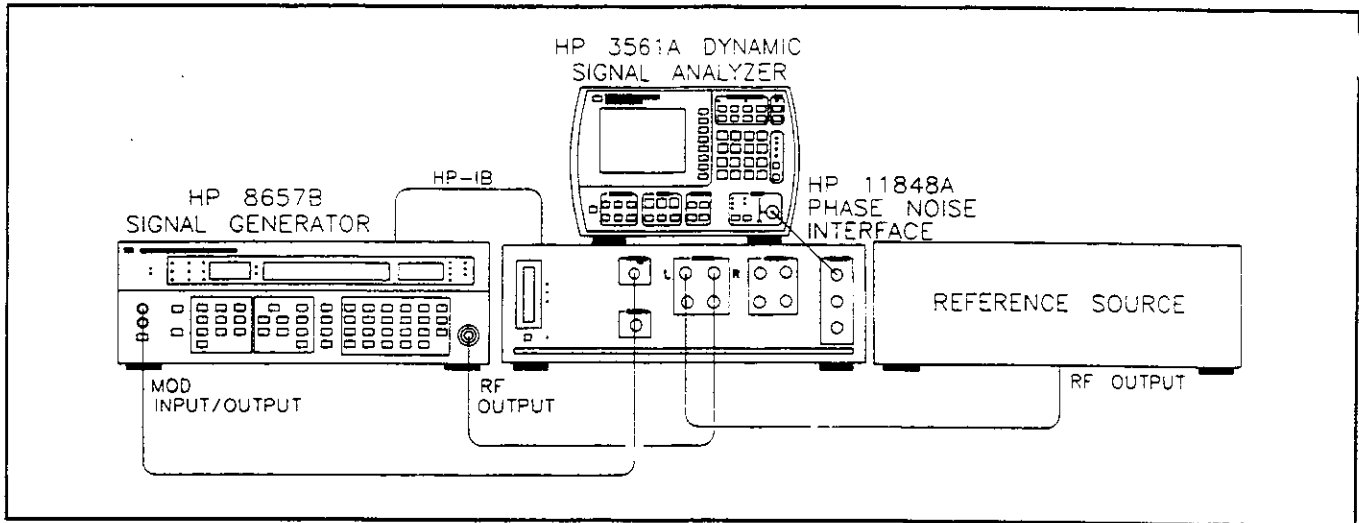

Figure 4-7. Setup Diagram for SSB Phase Noise Measurement

14. After you have connected the cables, press the **Proceed** key to run the measurement. (If you wish to measure the phase noise level of the Signal Generator at other center frequency settings after this test is completed, change the center frequency on the reference source to the desired frequency. Enter the desired frequency as the carrier frequency and detector/disc input frequency in the Source and Interface Parameter Entry menu.)

NOTE

If the noise level measured by the HP 3048A exceeds the Signal Generator's specified noise level and the exact noise level of the reference source is not known, the exact level of each source should be determined by measuring each source against a third signal source and comparing the measurement results for all three measurements.

15. The Measured SSB Phase Noise should be at or below the specified value.

Offset from Carrier	HP 8657A SSB Phase Noise		Carrier Frequency (MHz)
	Min.	Actual	
20 kHz	-124 dBc/Hz	_____	0.1 to 129
	-136 dBc/Hz	_____	130 to 260
	-130 dBc/Hz	_____	260 to 520
	-124 dBc/Hz	_____	520 to 1040

Offset from Carrier	HP 8657B SSB Phase Noise		Carrier Frequency (MHz)
	Min.	Actual	
20 kHz	-124 dBc/Hz	_____	0.1 to 129
	-136 dBc/Hz	_____	130 to 260
	-130 dBc/Hz	_____	260 to 520
	-124 dBc/Hz	_____	520 to 1040
	-118 dBc/Hz	_____	1040 to 1600

Table 4-2. Parameter Data Loaded from HP Example RF Synthesizer (HP 8662/3 DCFM file)

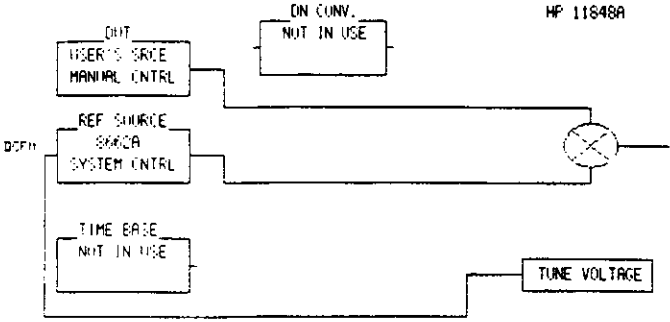
Parameters	Data
Measurement Type Frequency Range Start Freq. Stop Freq. Averages	Phase Noise Using a Phase Lock Loop 1 Hz 100 E + 3 Hz 4
Source Parameters Carrier Frequency Detector/Discr. Input Frequency VCO Tuning Constant Center Voltage of VCO Tuning Curve Voltage Tuning Range of VCO VCO Tune-Port Input Resistance Internal Phase Detector	500 E + 6 Hz 500 E + 6 Hz 25 E + 3 Hz/V 0 Volts ±2 Volts 600 ohms 5 MHz to 1600 MHz
Phase Detector Constant VCO Tuning Constant PLL Suppression	Measure the Detector Constant Measure the VCO Tuning Constant Will be verified
Source Control	
Define Graph Title Minimum X Maximum X Minimum Y Maximum Y Graph Type	RF SYNTHESIZER VERSUS HP 8662/3A USING DC FM. 1 Hz 100 E + 3 Hz -170 0 Single Sideband Phase Noise (dBc/Hz)

Performance Test 2

OUTPUT LEVEL ACCURACY AND FLATNESS TESTS

- Level Flatness
- Absolute Level Accuracy

HP 8656B Specifications

Electrical Characteristics	Performance Limits	Conditions
Output Level Range (into 50 ohms) Resolution Absolute Level Accuracy ⁽¹⁾ Level Flatness	+13 dBm to -127 dBm 0.1 dB $\leq \pm 1.0$ dB $< \pm 1.5$ dB $\leq \pm 1.0$ dB	100 kHz to 990 MHz Output levels of +7 dBm to -124 dBm frequencies from 123.5 to 990 MHz 100kHz to 123.5 MHz and output levels > +7dBm or < -124 dBm; frequencies 100kHz to 990 MHz Output level setting of 0.0 dBm; frequencies from 100 kHz to 990 MHz
(1) Absolute level accuracy includes allowances for detector linearity, temperature, flatness, attenuator accuracy, and measurement errors.		

HP 8657A Specifications

Electrical Characteristics	Performance Limits	Conditions
Output Level Range (into 50 ohms) Resolution Absolute Level Accuracy ⁽¹⁾ Level Flatness	+13 dBm to -143.5 dBm +10 dBm to -143.5 dBm 0.1 dB $\leq \pm 1.0$ dB $< \pm 1.5$ dB $\leq \pm 0.5$ dB	1 MHz to 1040 MHz 100 kHz to 1 MHz Output levels of +7 dBm to -127 dBm > +7 dBm Output level setting of 0.0 dBm; frequencies from 100 kHz to 1040 MHz
(1) Absolute level accuracy includes allowances for detector linearity, temperature, flatness, attenuator accuracy, and measurement errors.		

HP 8657B Specifications

Electrical Characteristics	Performance Limits	Conditions
Output		
Level Range (into 50 ohms)	+13 dBm to -143.5 dBm +10 dBm to -143.5 dBm	100 kHz to 2060 MHz Opt 003
Resolution	0.1 dB	
Absolute Level Accuracy ⁽¹⁾	$\leq \pm 1.0$ dB $< \pm 1.5$ dB	Output levels of +3.5 dBm to -127 dBm $> +3.5$ dBm
Level Flatness	$\leq \pm 0.5$ dB	Output level setting of 0.0 dBm; frequencies from 100 kHz to 2060 MHz
<p>(1) Absolute level accuracy includes allowances for detector linearity, temperature, flatness, attenuator accuracy, and measurement errors.</p>		

Description

Output level accuracy and flatness are verified using a measuring receiver and a sensor module.

Equipment

Measuring Receiver HP 8902A
 Sensor Module HP 11722A

Procedure

Level Flatness

1. Connect the sensor module to the measuring receiver. Zero and calibrate the sensor module and measuring receiver.
2. Connect the sensor module to the Signal Generator as shown in Figure 4-8.

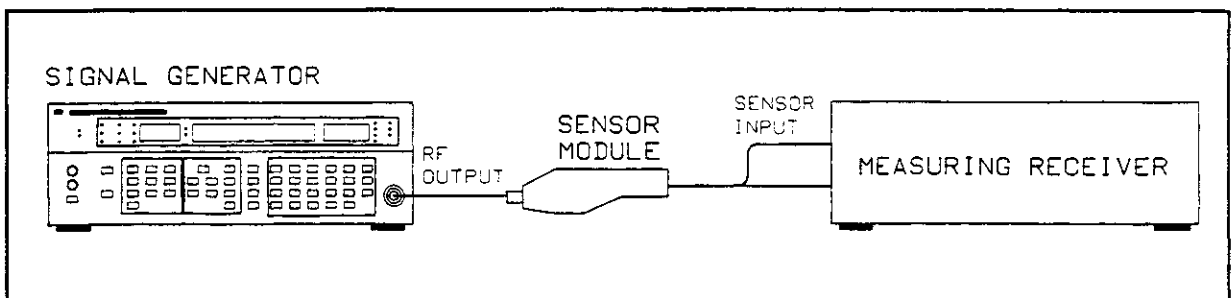

Figure 4-8. Output Level Accuracy and Flatness Test Setup

3. Set the measuring receiver as follows:

Measurement	RF POWER
Display	LOG
Frequency	100 kHz

4. Set the Signal Generator as follows:

Frequency	100 kHz
Amplitude	0.0 dBm
Modulation	Off

5. Wait for the power measurement to settle and then select DISPLAY RATIO on the measuring receiver to set a 0.0 dB. reference.

6. Set a Frequency Increment value on the Measuring Receiver and Signal Generator according to the frequency band of the measurements. Frequency Increment on the measuring receiver is set by entering the numeric value in kHz and pressing the kHz (up or down) keys. Upon entering that value the measuring receiver will also change the center frequency by that amount, the Signal Generator should be stepped to match. Dependant on the Signal Generator model under test, use increments of 100 kHz (100 kHz to 1 MHz), 1 MHz (1 MHz to 10 MHz), 10 MHz (10 MHz to 100 MHz), 100 MHz (100 MHz to 2000 MHz), and 60 MHz (2000 MHz to 2060 MHz).

7. Step the Signal Generator and measuring receiver through the frequency range. Ranges are:

- 100 kHz to 990 MHz for an HP 8656B
- 100 kHz to 1040 MHz for an HP 8657A
- 100 kHz to 2060 MHz for an HP 8657B

Record the highest and lowest power levels and their frequencies and calculate the maximum variation.

_____ Highest Reading	_____ Frequency
_____ Lowest Reading	_____ Frequency

The amplitude variation should not exceed 2.0 dB for the HP 8656B and 1.0 dB for the HP 8657A/8657B. Record the maximum variation (highest reading – lowest reading).

_____ <2.0 dB (HP 8656B only)
_____ <1.0 dB (HP 8657A/8657B only)

RF Output Test Frequency 1 _____
 RF Output Test Frequency 2 _____

RF Output Test Frequency 3 _____
 RF Output Test Frequency 4 _____

All Models	HP 8656B Only (100 kHz to 123.5 MHz)				HP 8656B (> 123.5 MHz), HP 8657A, HP 8657B				
	Amplitude Setting (dBm)	Minimum (dBm)	Maximum (dBm)	Actual (dBm)		Minimum (dBm)	Maximum (dBm)	Actual (dBm)	
				Freq 1	Freq 2			Freq 3	Freq 4
+13.0 ¹	+11.5	+14.5	_____	_____	+11.5	+14.5	_____	_____	
+8.0	+6.5	+9.5	_____	_____	+6.5	+9.5	_____	_____	
+3.0	+1.5	+4.5	_____	_____	+2.0	+4.0	_____	_____	
-2.0	-3.5	-0.5	_____	_____	-3.0	-1.0	_____	_____	
-7.0	-8.5	-5.5	_____	_____	-8.0	-6.0	_____	_____	
-12.0	-13.5	-10.5	_____	_____	-13.0	-11.0	_____	_____	
-17.0	-18.5	-15.5	_____	_____	-18.0	-16.0	_____	_____	
-22.0	-23.5	-20.5	_____	_____	-23.0	-21.0	_____	_____	
-27.0	-28.5	-25.5	_____	_____	-28.0	-26.0	_____	_____	
-32.0	-33.5	-30.5	_____	_____	-33.0	-31.0	_____	_____	
-37.0	-38.5	-35.5	_____	_____	-38.0	-36.0	_____	_____	
-42.0	-43.5	-40.5	_____	_____	-43.0	-41.0	_____	_____	
-47.0	-48.5	-45.5	_____	_____	-48.0	-46.0	_____	_____	
-52.0	-53.5	-50.5	_____	_____	-53.0	-51.0	_____	_____	
-57.0	-58.5	-55.5	_____	_____	-58.0	-56.0	_____	_____	
-62.0	-63.5	-60.5	_____	_____	-63.0	-61.0	_____	_____	
-67.0	-68.5	-65.5	_____	_____	-68.0	-66.0	_____	_____	
-72.0	-73.5	-70.5	_____	_____	-73.0	-71.0	_____	_____	
-77.0	-78.5	-75.5	_____	_____	-78.0	-76.0	_____	_____	
-82.0	-83.5	-80.5	_____	_____	-83.0	-81.0	_____	_____	
-87.0	-88.5	-85.5	_____	_____	-88.0	-86.0	_____	_____	
-92.0	-93.5	-90.5	_____	_____	-93.0	-91.0	_____	_____	
-97.0	-98.5	-95.5	_____	_____	-98.0	-96.0	_____	_____	
-102.0	-103.5	-100.5	_____	_____	-103.0	-101.0	_____	_____	
-107.0	-108.5	-105.5	_____	_____	-108.0	-106.0	_____	_____	
-112.0	-113.5	-110.5	_____	_____	-113.0	-111.0	_____	_____	
-117.0	-118.5	-115.5	_____	_____	-118.0	-116.0	_____	_____	
-122.0	-123.5	-120.5	_____	_____	-123.0	-121.0	_____	_____	
-127.0	-128.5	-125.5	_____	_____	-128.0 ²	-126.0 ²	_____	_____	
-127.0			_____	_____	-128.5 ³	-125.5 ³	_____	_____	

¹ +13.0 dBm does not apply to HP 8657B with Pulse Modulation installed.
² HP 8657A and HP 8657B only.
³ HP 8656B only < - 124.0 dBm.

Performance Test 3

MODULATION TESTS

- **AC Modulation**
 - AM Indicator Accuracy
 - Incidental Phase Modulation
 - AM Distortion
 - FM Indicator Accuracy
 - Incidental AM
 - FM Distortion
- **DC Modulation**
 - DC FM Center Frequency Accuracy
 - DC FM Center Frequency Stability
- **Pulse Modulation (HP 8657B only)**
 - ON OFF Ratio
 - Rise/Fall Time

HP 8656B Specifications

Electrical Characteristics	Performance Limits	Conditions
Amplitude Modulation		
Depth ⁽¹⁾	0 to 99%	Output levels ≤ +7 dBm; frequencies from 100 kHz to 990 MHz
	0 to 30%	Output levels ≤ +10 dBm; frequencies from 100 kHz to 990 MHz
Resolution	1%	
Incidental Phase Modulation	< 0.3 radian peak	30% AM depth and internal rates.
Indicator Accuracy ⁽¹⁾	± (4% of setting + 2%)	Depths < 90% and internal rates and levels ≤ +7 dBm
AM Rates:		
Internal	400 and 1 kHz, ± 3%	
External	20 Hz to 40 kHz	1 dB bandwidth, ac coupled
AM Distortion (internal rates)	< 1.5%	0 to 30% AM
	< 3%	31 to 70% AM
	< 4%	71 to 90% AM
FM Modulation		
Maximum Peak Deviation (Δf _{pk}): ⁽²⁾		
Rates ≥ 25 Hz (ac mode)	99 kHz	0.1 to 123.5 MHz (fc)
Rates ≥ 50 Hz (ac mode)	50 kHz	123.5 to 247 MHz (fc)
Rates ≥ 50 Hz (ac mode)	99 kHz	247 to 494 MHz (fc)
Rates ≥ 25 Hz (ac mode)	99 kHz	494 to 990 MHz (fc)
<p>(1) AM Depth is further limited by the Indicator Accuracy specification.</p> <p>(2) FM deviation is further limited by the Indicator Accuracy specification.</p>		

HP 8656B Specifications (Continued)

Electrical Characteristics	Performance Limits	Conditions
<p>FM Modulation (Cont'd)</p> <p>Maximum Peak Deviation (Δf_{pk}):⁽²⁾ (Cont'd)</p> <p>Rates < 25 Hz (ac mode)</p> <p>Rates < 50 Hz (ac mode)</p> <p>Rates < 50 Hz (ac mode)</p> <p>Rates < 25 Hz (ac mode)</p> <p>Rates (dc mode)</p> <p>Center Frequency Accuracy (dc mode)</p> <p>Stability (dc mode)</p> <p>Resolution</p> <p>Incidental AM</p> <p>Indicator Accuracy⁽²⁾</p> <p>FM Distortion (Total Harmonic Distortion)^(3,4)</p> <p>FM Rates:</p> <p>Internal</p> <p>External</p>	<p>4000 × Rate Hz</p> <p>1000 × Rate Hz</p> <p>2000 × Rate Hz</p> <p>4000 × Rate Hz</p> <p>99 kHz</p> <p>50 kHz</p> <p>99 kHz</p> <p>99 kHz</p> <p>± 500 Hz</p> <p>± 125 Hz</p> <p>± 250 Hz</p> <p>± 500 Hz</p> <p>< 10 Hz/hour</p> <p>0.1 kHz</p> <p>1 kHz</p> <p>< 0.1%</p> <p>< 1.0%</p> <p>< 5.0%</p> <p>± 5% of reading</p> <p>< 0.5%</p> <p>400 and 1 kHz, ± 3%</p> <p>dc to 50 kHz</p> <p>dc to 100 kHz</p>	<p>0.1 to 123.5 MHz (fc)</p> <p>123.5 to 247 MHz (fc)</p> <p>247 to 494 MHz (fc)</p> <p>494 to 990 MHz (fc)</p> <p>0.1 to 123.5 MHz (fc)</p> <p>123.5 to 247 MHz (fc)</p> <p>247 to 494 MHz (fc)</p> <p>494 to 990 MHz (fc)</p> <p>0.1 to 123.5 MHz (fc)</p> <p>123.5 to 247 MHz (fc)</p> <p>247 to 494 MHz (fc)</p> <p>494 to 990 MHz (fc)</p> <p>Deviations < 10 kHz</p> <p>Deviations ≥ 10 kHz</p> <p>< 20 kHz peak deviation and internal rates:</p> <p>> 500 kHz (fc)</p> <p>200 to 500 kHz (fc)</p> <p>< 200 kHz (fc)</p> <p>At internal rates</p> <p>≥ 3 kHz peak deviations and at internal rates</p> <p>ac coupled, ± 1 dB 20 Hz to 50 kHz</p> <p>± 3 dB</p>

(2) FM deviation is further limited by the Indicator Accuracy specification.

(3) FM distortion only applies at deviations up to 25 kHz for 123.5 < f_c < 247 MHz, and 50 kHz for 247 < f_c < 494 MHz. Typical total FM distortion (harmonic and non-harmonic) is less than 1.5% for all specified deviations and external rates of dc to 100 kHz.

(4) Typically < 0.5% THD for peak deviations > 1 kHz and at internal rates.

HP 8657A Specifications

Electrical Characteristics	Performance Limits	Conditions
Amplitude Modulation		
Depth ⁽¹⁾	0 to 99%	Output levels $\leq +7$ dBm; frequencies from 100 kHz to 1040 MHz
	0 to 30%	Output levels $\leq +10$ dBm; frequencies from 100 kHz to 1040 MHz
Resolution	1%	
Incidental Phase Modulation	< 0.3 radian peak	30% AM depth and internal rates.
Indicator Accuracy ⁽¹⁾	$\pm (6\% \text{ of setting} + 2\%)$	Depths $< 90\%$ and internal rates and levels $\leq +7$ dBm.
AM Rates:		
Internal	400 and 1 kHz, $\pm 3\%$	
External	20 Hz to 40 kHz	1 dB bandwidth, ac coupled
AM Distortion		
(internal rates)	$< 1.5\%$	0 to 30% AM
	$< 3\%$	31 to 70% AM
	$< 4\%$	71 to 90% AM
FM Modulation		
Maximum Peak Deviation		
(Δf_{pk}):⁽²⁾		
Rates ≥ 25 Hz (ac mode)	99 kHz	0.1 to 130 MHz (fc)
Rates ≥ 50 Hz (ac mode)	50 kHz	130 to 260 MHz (fc)
Rates ≥ 50 Hz (ac mode)	99 kHz	260 to 520 MHz (fc)
Rates ≥ 25 Hz (ac mode)	99 kHz	520 to 1040 MHz (fc)
Rates < 25 Hz (ac mode)	$4000 \times \text{Rate Hz}$	0.1 to 130 MHz (fc)
Rates < 50 Hz (ac mode)	$1000 \times \text{Rate Hz}$	130 to 260 MHz (fc)
Rates < 50 Hz (ac mode)	$2000 \times \text{Rate Hz}$	260 to 520 MHz (fc)
Rates < 25 Hz (ac mode)	$4000 \times \text{Rate Hz}$	520 to 1040 MHz (fc)
Rates (dc mode)		
	99 kHz	0.1 to 130 MHz (fc)
	50 kHz	130 to 260 MHz (fc)
	99 kHz	260 to 520 MHz (fc)
	99 kHz	520 to 1040 MHz (fc)
Center Frequency		
Accuracy (dc mode)	± 500 Hz	0.1 to 130 MHz (fc)
	± 125 Hz	130 to 260 MHz (fc)
	± 250 Hz	260 to 520 MHz (fc)
	± 500 Hz	520 to 1040 MHz (fc)
⁽¹⁾ AM Depth is further limited by the Indicator Accuracy specification.		
⁽²⁾ FM deviation is further limited by the Indicator Accuracy specification.		

HP 8657A Specifications (Continued)

Electrical Characteristics	Performance Limits	Conditions
<p>FM Modulation (Cont'd) Maximum Peak Deviation (Δf_{pk}):⁽²⁾ (Cont'd) Stability (dc mode) Resolution Incidental AM Indicator Accuracy⁽²⁾ FM Distortion (Total Harmonic Distortion)^(3,4) FM Rates: Internal External</p>	<p>< 10 Hz/hour 0.1 kHz 1 kHz < 0.1% ± 5% of reading < 0.5% 400 and 1 kHz, ± 2% dc to 50 kHz dc to 100 kHz</p>	<p>Deviations < 10 kHz Deviations ≥ 10 kHz < 20 kHz peak deviation and internal rates: ≥ 500 kHz (fc) At internal rates ≥ 3 kHz peak deviations and at internal rates ac coupled, ± 1 dB 20 Hz to 50 kHz ± 3 dB</p>
<p>(2) FM deviation is further limited by the Indicator Accuracy specification. (3) FM distortion only applies at deviations up to 25 kHz for $130 < f_c < 260$ MHz, and 50 kHz for $260 < f_c < 520$ MHz. Typical total FM distortion (harmonic and non-harmonic) is less than 1.5% for all specified deviations and external rates of dc to 100 kHz. (4) Typically < 0.5% THD for peak deviations > 1 kHz and at internal rates.</p>		

HP 8657B Specifications

Electrical Characteristics	Performance Limits	Conditions
Amplitude Modulation		
Depth ^(1,2)	0 to 100%	Output levels $\leq +7$ dBm; frequencies from 400 kHz to 2060 MHz
	0 to 30%	Output levels $\leq +10$ dBm; frequencies from 400 kHz to 2060 MHz
Resolution	1%	
Incidental Phase Modulation	< 0.3 radian peak	30% AM depth and internal rates.
Indicator Accuracy ⁽¹⁾	$\pm (6\% \text{ of setting} + 2\%)$	Depths $< 90\%$ and internal rates and levels $\leq +7$ dBm.
AM Rates		
Internal	400 and 1 kHz, $\pm 2\%$	
External	20 Hz to 40 kHz	1 dB bandwidth, ac coupled
AM Distortion, 1 kHz internal rate Levels ≥ 7 dBm	$< 1.5\%$ $< 3\%^2$ $< 4\%$ $< 4\%$ $< 4\%$ $< 7\%$	0 to 30% AM frequencies < 1030 31 to 70% AM frequencies < 1030 71 to 90% AM frequencies < 1030 0 to 30% AM frequencies > 1030 31 to 70% AM frequencies > 1030 71 to 90% AM frequencies > 1030
FM Modulation		
Maximum Peak Deviation (Δf_{pk}): ⁽³⁾		
20 Hz to 50 kHz	200 kHz	0.1 to 130 MHz (fc)
1 dB Bandwidth	50 kHz	130 to 260 MHz (fc)
	100 kHz	260 to 520 MHz (fc)
	200 kHz	520 to 1040 MHz (fc)
	400 kHz	1040 to 2060 MHz (fc)
	4000 \times Rate Hz	0.1 to 130 MHz (fc)
	1000 \times Rate Hz	130 to 260 MHz (fc)
	2000 \times Rate Hz	260 to 520 MHz (fc)
	4000 \times Rate Hz	520 to 1040 MHz (fc)
	8000 \times Rate Hz	1040 to 2060 MHz (fc)
Rates (dc mode)	200 kHz	0.1 to 130 MHz (fc)
	50 kHz	130 to 260 MHz (fc)
	100 kHz	260 to 520 MHz (fc)
	200 kHz	520 to 1040 MHz (fc)
	400 kHz	1040 to 2060 MHz (fc)
Center Frequency Accuracy (dc mode)	± 500 Hz	0.1 to 130 MHz (fc)
	± 125 Hz	130 to 260 MHz (fc)
	± 250 Hz	260 to 520 MHz (fc)
	± 500 Hz	520 to 1040 MHz (fc)
	± 1000 Hz	1040 to 2060 MHz (fc)
<p>(1) AM Depth is further limited by the indicator Accuracy specification.</p> <p>(2) When Opt. 003 is installed, output level in AM is reduced by 3 dB and AM Distortion is $< 4\%$ at 31 to 70% AM when f_c is < 1030 MHz.</p> <p>(3) FM deviation is further limited by the indicator Accuracy specification.</p>		

HP 8657B Specifications (Continued)

Electrical Characteristics	Performance Limits	Conditions
<p>FM Modulation (Cont'd) Maximum Peak Deviation (Δf_{pk}):⁽³⁾ (Cont'd)</p> <p>Stability (dc mode)</p> <p>Resolution</p> <p>Incidental AM</p> <p>Indicator Accuracy⁽³⁾</p> <p>FM Distortion (Total Harmonic Distortion)⁽⁴⁾</p> <p>FM Rates:</p> <p> Internal</p> <p> External</p> <p> External</p> <p>Pulse Modulation ON/OFF Ratio:</p> <p>Rise/Fall Time:</p>	<p>< 10 Hz/hour</p> <p>0.1 kHz 1 kHz 0.2 kHz 2 kHz</p> <p>< 0.1% < 0.5%</p> <p>$\pm 5\%$ of reading</p> <p>< 0.5%</p> <p>400 and 1 kHz, $\pm 2\%$ 20 Hz to 50 kHz 5 Hz to 100 kHz dc to 50 kHz dc to 100 kHz</p> <p>> 70 dB > 95 dB</p> <p>< 35 ns < 50 ns</p>	<p>Deviations < 100 kHz, $f_c < 1030$ MHz Deviations ≥ 100 kHz, $f_c < 1030$ MHz Deviations < 100 kHz, $f_c > 1030$ MHz Deviations ≥ 100 kHz, $f_c > 1030$ MHz</p> <p>< 20 kHz peak deviation and internal rates: 500 kHz to 1030 MHz 1030 MHz to 2060 MHz</p> <p>At internal 1kHz rate</p> <p>≥ 6 kHz peak deviations and at internal 1kHz rate</p> <p>ac coupled, ± 1 dB. ± 3 dB. dc coupled, ± 1 dB. ± 3 dB.</p> <p>< 1030 MHz: ≥ 1030 MHz:</p> <p>< 1030 MHz ≥ 1030 MHz</p>
<p>⁽³⁾ FM deviation is further limited by the Indicator Accuracy specification.</p> <p>⁽⁴⁾ FM distortion only applies at deviation at 1/2 maximum, $f_c < 520$ MHz. Typical total FM distortion (harmonic and non-harmonic) is less than 1.5% for all specified deviations and external rates of dc to 100 kHz.</p>		

AC MODULATION

Description

AC modulation specifications are verified by measuring the specified parameters with a measuring receiver. Distortion is verified by measuring the demodulated output from the measuring receiver with a distortion analyzer.

Equipment

Measuring Receiver	HP 8902A
Sensor Module	HP 11722A
Audio Analyzer and Source	HP 8903B
AM/FM Test Source	HP 11715A
Cable (UG-21D/U type N connectors)	HP 11500B
Cable (UG-88C/U BNC and dual banana plug connectors)	HP 11001-60001

Procedure

AM Indicator Accuracy

1. Connect the RF OUTPUT of the Signal Generator to the input of the measuring receiver as shown in Figure 4-9.

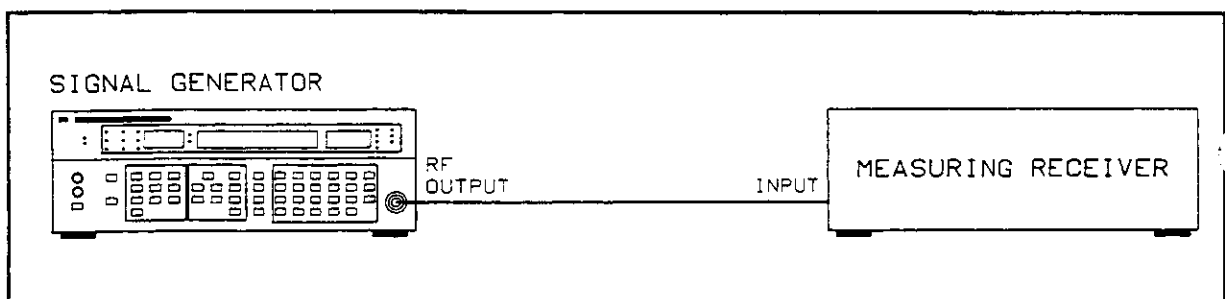

Figure 4-9. Modulation Test Setup

2. Set the measuring receiver as follows:

Measurement	AM
Detector	Peak+ and Peak -
HP Filter	300 Hz
LP Filter	15 kHz
FM De-Emphasis	Off
Automatic Operation	Selected

3. Set the Signal Generator as follows:

Frequency	100 MHz
Amplitude (HP 8656B/8657A)	+7 dBm
Amplitude (HP 8657B)	+4 dBm
Amplitude (HP 8657B (with Pulse Modulation installed))	+1 dBm
Modulation	1 kHz (Int.) AM 10%

4. Set the AM depth to the values listed in the following table and verify that the measured results are within the limits specified.

MHz	AM Depth	Results				
		Min.		Actual	Max.	
		HP 8656B	HP8657A HP8657B		HP 8656B	HP 8657A HP 8657B
100	10%	7.6%	7.4%	_____	12.4%	12.6%
	30%	26.8%	26.2%	_____	33.2%	33.8%
	70%	65.2%	63.8%	_____	74.8%	76.2%
	90%	84.4%	82.6%	_____	95.6%	97.4%
240	10%	7.6%	7.4%	_____	12.4%	12.6%
	30%	26.8%	26.2%	_____	33.2%	33.8%
	70%	65.2%	63.8%	_____	74.8%	76.2%
	90%	84.4%	82.6%	_____	95.6%	97.4%
400	10%	7.6%	7.4%	_____	12.4%	12.6%
	30%	26.8%	26.2%	_____	33.2%	33.8%
	70%	65.2%	63.8%	_____	74.8%	76.2%
	90%	84.4%	82.6%	_____	95.6%	97.4%
990	10%	7.6%	7.4%	_____	12.4%	12.6%
	30%	26.8%	26.2%	_____	33.2%	33.8%
	70%	65.2%	63.8%	_____	74.8%	76.2%
	90%	84.4%	82.6%	_____	95.6%	97.4%
1030 (HP 8657A & HP 8657B only)	10%	N/A	7.4%	_____	N/A	12.6%
	30%		26.2%	_____		33.8%
	70%		63.8%	_____		76.2%
	90%		82.6%	_____		97.4%
1040 (HP 8657A & HP 8657B only)	10%	N/A	7.4%	_____	N/A	12.6%
	30%		26.2%	_____		33.8%
	70%		63.8%	_____		76.2%
	90%		82.6%	_____		97.4%
1300 (HP 8657B only)	10%	N/A	7.4%	_____	N/A	12.6%
	30%		26.2%	_____		33.8%
	70%		63.8%	_____		76.2%
	90%		82.6%	_____		97.4%

5. Select the measuring receiver's 50 Hz high-pass filter. Set the AM depth to the values listed in the following table and verify that the measured results are within the limits specified with the Signal Generator frequency at 100 MHz and internal 400 Hz AM modulation.

MHz	AM Depth	Results				
		Min.		Actual	Max.	
		HP 8656B	HP8657A HP8657B		HP 8656B	HP 8657A HP 8657B
100	10%	7.6%	7.4%	_____	12.4%	12.6%
	30%	26.8%	26.2%	_____	33.2%	33.8%
	70%	65.2%	63.8%	_____	74.8%	76.2%
	90%	84.4%	82.6%	_____	95.6%	97.4%

Incidental Phase Modulation

6. Set the measuring receiver as follows:

Measurement Phase Modulation
 HP Filter 300 Hz
 LP Filter 15 kHz
 Detector Peak+

7. Set the Signal Generator as follows:

Frequency 150 kHz
 Frequency Increment 150 kHz
 Amplitude (HP 8656B/8657A) +7 dBm
 Amplitude (HP 8657B) +4 dBm
 Amplitude (HP 8657B with Pulse Modulation installed) +1 dBm
 Modulation 1 kHz (Int.) AM 30%

8. Step the Signal Generator through the frequency range from 150 kHz and record the highest reading. The highest reading should not exceed the limit specified. Dependant on the Signal Generator model under test, use increments of 50 kHz (150 kHz to 200 kHz), 100 kHz (200 kHz to 1 MHz), 1 MHz (1 MHz to 10 MHz), 10 MHz (10 MHz to 100 MHz), 100 MHz (100 MHz to 2000 MHz), and 60 MHz (2000 MHz to 2060 MHz).

Model	Frequency		Result	
	Min.	Max.	Actual	Max.
HP 8656B	150 kHz	990 MHz	_____	< 0.3 radian peak
HP 8657A	150 kHz	1040 MHz	_____	< 0.3 radian peak
HP 8657B	150 kHz	1300 MHz	_____	< 0.3 radian peak

AM Distortion

9. Set the Measuring Receiver as follows:

Measurement AM
 HP Filter 300 Hz
 LP Filter 15 kHz
 Detector Peak+ and Peak-

10. Set the Audio Analyzer as follows:

Measurement Distortion

11. Set the Signal Generator as follows:

Frequency 10 MHz
 Amplitude (HP 8656B/8657A) +7 dBm
 Amplitude (HP 8657B) +4 dBm
 Amplitude (HP 8657B (with Pulse Modulation installed)) +1 dBm
 Modulation 1 kHz (Int.) AM 30%

12. Set the AM depth to the values listed in the following table and verify that the measured results do not exceed the limits specified.

MHz	AM Depth	Results			
		Actual	Max.		
			HP 8656B	HP 8657A	HP 8657B
100	30%	_____	< 1.5%	< 1.5%	< 1.5%
	70%	_____	< 3.0%	< 3.0%	< 3.0%
	90%	_____	< 4.0%	< 4.0%	< 4.0%
240	30%	_____	< 1.5%	< 1.5%	< 1.5%
	70%	_____	< 3.0%	< 3.0%	< 3.0%
	90%	_____	< 4.0%	< 4.0%	< 4.0%
400	30%	_____	< 1.5%	< 1.5%	< 1.5%
	70%	_____	< 3.0%	< 3.0%	< 3.0%
	90%	_____	< 4.0%	< 4.0%	< 4.0%
990	30%	_____	< 1.5%	< 1.5%	< 1.5%
	70%	_____	< 3.0%	< 3.0%	< 3.0%
	90%	_____	< 4.0%	< 4.0%	< 4.0%
1030	30%	_____	N/A	< 1.5%	< 4.0%
	70%	_____		< 3.0%	< 4.0%
	90%	_____		< 4.0%	< 7.0%
1040	30%	_____	N/A	< 1.5%	< 4.0%
	70%	_____		< 3.0%	< 4.0%
	90%	_____		< 4.0%	< 7.0%
1300	30%	_____	N/A	N/A	< 4.0%
	70%	_____			< 4.0%
	90%	_____			< 7.0%

FM Indicator Accuracy

13. Set the measuring receiver as follows:

Measurement FM
 Detector Peak+
 HP Filter 300 Hz
 LP Filter 3 kHz

14. Set the Signal Generator as follows:

Frequency 100 MHz
 Amplitude (HP 8656B/8657A) +7 dBm
 Amplitude (HP 8657B) +4 dBm
 Amplitude (HP 8657B (with Pulse Modulation installed)) +1 dBm
 Modulation 1 kHz (Int) FM 5 kHz

15. Set FM deviation to the values listed in the following table and verify that the measured results are within the limits specified.

FM Deviation for 100 MHz	Results		
	Min.	Actual	Max.
5.0 kHz	4.75 kHz	_____	5.25 kHz
30.0 kHz	28.50 kHz	_____	31.50 kHz
70.0 kHz	66.50 kHz	_____	73.50 kHz
99.0 kHz	94.05 kHz	_____	103.95 kHz

Incidental AM

The incidental AM specification of the Signal Generator is not equivalent to the published specification of the HP 8902A Measuring Receiver. To make a valid incidental AM measurement, the incidental AM of the measuring receiver must be four times better than the specification being tested. In order to verify that the incidental AM of the measuring receiver is adequate to measure the Signal Generator's incidental AM specification, the incidental AM of the measuring receiver must be verified to ensure the validity of the measurement. If the Signal Generator's incidental AM is measured frequently, it is not necessary to verify the incidental AM of the measuring receiver each time; however, it is recommended that it be verified monthly to ensure an accurate measurement.

16. Verify the incidental AM of the measuring receiver as follows:

- a. Connect the FM divide-by-4 output of the AM/FM test source to the input of the measuring receiver and the 50 ohm output of the test oscillator to the audio input of the AM/FM test source, as shown in Figure 4-10.
- b. Set the measuring receiver as follows:

Measurement Frequency

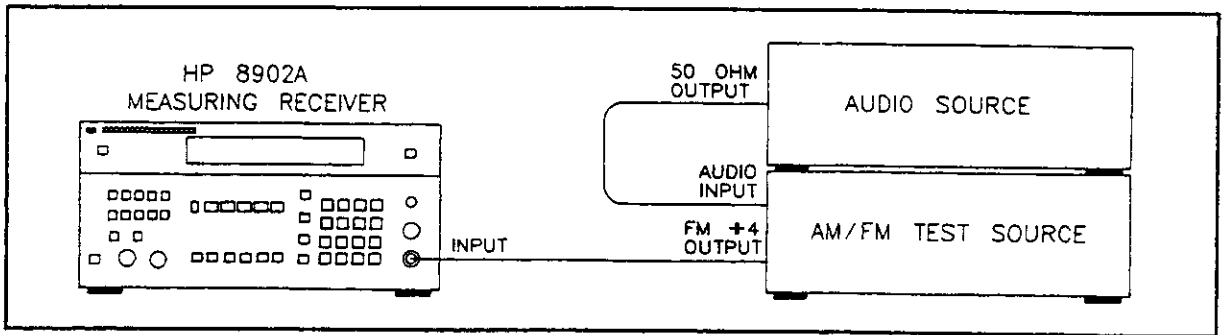

Figure 4-10. Measuring Receiver Incidental AM Verification Test Setup

- c. Set the AM/FM test source as follows:
 - Test Mode..... FM
 - d. Tune the carrier frequency on the AM/FM test source for a measuring receiver reading of 100 MHz \pm 0.1 MHz.
 - e. Set the test oscillator as follows:
 - Frequency..... 1 kHz
 - Output Attenuator..... -10 dBm
 - Amplitude Course..... Fully ccw
 - f. Set the measuring receiver as follows:
 - Measurement..... FM
 - Detector..... Peak+
 - HP Filter..... 300 Hz
 - LP Filter..... 3 kHz
 - g. Increase the output of the test oscillator by rotating the Amplitude Coarse control clockwise until the measuring receiver indicates 20.0 kHz \pm 0.1 kHz peak deviation.
 - h. Set the measuring receiver as follows:
 - Measurement..... AM
 - i. The modulation must be < 0.02% AM to test the incidental AM of the Signal Generator.
17. Set the measuring receiver as follows:
- Measurement..... AM
 - Detector..... Peak+
 - HP Filter..... 300 Hz
 - LP Filter..... 3 kHz
18. Set the Signal Generator as follows:
- Amplitude (HP 8656B/8657A)..... +7 dBm
 - Amplitude (HP 8657B)..... +4 dBm
 - Amplitude (HP 8657B (with Pulse Modulation installed))..... +1 dBm
 - Modulation..... 1 kHz (Int) FM 20 kHz
19. Connect the equipment as shown in Figure 4-9, Modulation Test Setup.

20. Set the Signal Generator frequency to a value within the range specified in the following table and verify that the measured result does not exceed the limit specified.

Model	Frequency		Result	
	Min.	Max.	Actual	Max.
HP 8656B	10 MHz	990 MHz	_____	< 0.1%
HP 8657A	10 MHz	1040 MHz	_____	< 0.1%
HP 8657B	10 MHz	1030 MHz	_____	< 0.1%
	1030 MHz	1300 MHz	_____	< 0.5%

NOTE

Below 10 MHz, the incidental AM of the Signal Generator is less than that of the measuring receiver.

FM Distortion

21. Set the measuring receiver as follows:

Measurement FM
 Detector Peak+
 HP Filter 300 Hz
 LP Filter 3 kHz

22. Set the distortion analyzer as follows:

Function Distortion
 Analyzer Input Select Distortion
 Frequency 1 kHz

23. Set the Signal Generator as follows:

Frequency (HP 8656B) 100.0 MHz
 Frequency (HP 8657A and HP 8657B) 150.0 MHz
 Amplitude +4 dBm
 Modulation 1 kHz (Int) FM

24. Connect the equipment as shown in Figure 4-9, Modulation Test Setup.

25. Verify that the measured Total Harmonic Distortion does not exceed 0.5%.

26. Set the Signal Generator FM deviation to a value within the range specified in the following table and verify that the measured result does not exceed the limit specified.

Model	FM Deviation		Result	
	Min.	Max.	Actual	Max.
HP 8656B	3 kHz	99 kHz	_____	<0.5%
HP 8657A	6 kHz	99 kHz	_____	<0.5%
HP 8657B	6 kHz	99 kHz	_____	<0.5%

NOTE

At peak deviations less than 3 kHz, residual FM and other type of FM distortion become a greater portion of the distortion reading. If the distortion falls within tolerance at or above 3 kHz, it may be safely assumed that the Signal Generator meets the test requirements.

DC MODULATION

Description

DC FM specifications are verified by measuring the RF OUTPUT frequency offset with a frequency counter.

Equipment

Frequency Counter HP 5328B OPT 31

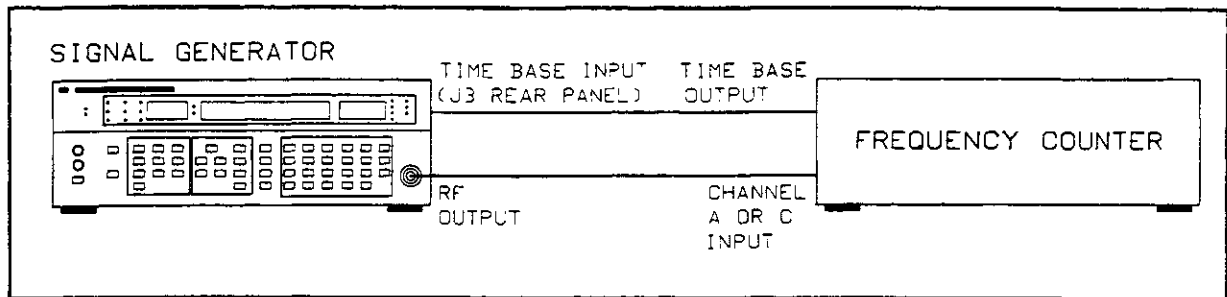

Figure 4-11. DC FM Test Setup

Procedure

DC FM Center Frequency Accuracy and Stability

27. Connect the RF OUTPUT from the Signal Generator to the INPUT of the frequency counter, and connect the Signal Generator TIME BASE INPUT to the Frequency counter TIME BASE OUTPUT as shown in Figure 4-11.

28. Set the frequency counter as follows:

INPUT CHANNEL A
 TRIGGER CHANNEL A

29. Set the Signal Generator as follows:

Frequency 100 MHz
 Amplitude 0 dBm
 Modulation DC FM

30. Set the Signal Generator FM deviation to a value for the frequency range specified in the following table. Verify that the measured frequency does not exceed the limits specified.

Model	Frequency (MHz)	DC FM Deviation (kHz)	Accuracy	Stability
			Offset (kHz)	Drift (Hz/Hr)
HP 8656B	0.1 to 123.5	1 to 99	_____ ± 500 Hz	_____ ± 10
	123.5 to 247	1 to 50	_____ ± 125 Hz	_____ ± 10
	247 to 494	1 to 99	_____ ± 250 Hz	_____ ± 10
	494 to 990	1 to 99	_____ ± 500 Hz	_____ ± 10
HP 8657A and HP 8657B	0.1 to 130	1 to 99	_____ ± 500 Hz	_____ ± 10
	130 to 269	1 to 50	_____ ± 125 Hz	_____ ± 10
	260 to 520	1 to 99	_____ ± 250 Hz	_____ ± 10
HP 8657A	520 to 1040	1 to 99	_____ ± 500 Hz	_____ ± 10
HP 8657B	520 to 1030	1 to 99	_____ ± 500 Hz	_____ ± 10
	1030 to 2060	1 to 99	_____ ± 1000 Hz	_____ ± 10

PULSE MODULATION (HP 8657B ONLY)

NOTE

Pulse Modulation is available as an option on the HP 8657B.

Description

The output of the HP 8657B is coupled to an oscilloscope and the Rise/Fall Time of the RF pulses is measured. The output of the HP 8657B is then coupled to a spectrum analyzer and the On/Off Level Ratio of the RF pulses is measured.

Equipment

Oscilloscope	HP 54100A
Oscilloscope Probe	HP 54002A
Pulse Generator	HP 8116A
Spectrum Analyzer	HP 8562B

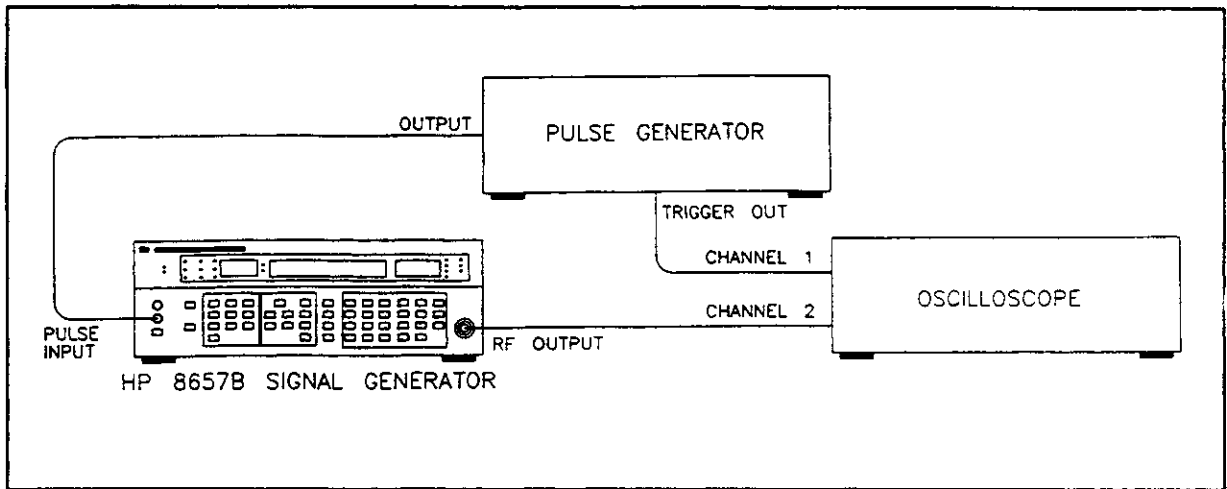

Figure 4-12. Modulation Test Setup

Procedure

31. Connect the equipment as shown in Figure 4-12.

32. Set the HP 8657B as follows:

Frequency	See Table
Amplitude	0 dBm
Modulation	Pulse

33. Set the Pulse Generator as follows:

Mode Normal
 Function Pulse
 Frequency 50 kHz
 Amplitude 1 Volt
 Amplitude Offset 1 Volt
 Pulse Width 10 usec
 Output Disable Off (LED Off)

34. Set the Oscilloscope as follows:

Timebase

Sec/Div 10 ns
 Delay 100 ns
 Delay Reference Center

Trigger

Mode Edge
 Source Chan 2
 Trigger Level 1.25 V
 Slope Pos

Display

Mode Normal
 Display Time (Persistence) 2 sec
 Split Screen Off
 Graticle Grid

Channel 1

Mode Normal
 Display On
 Volts/Div 100 mV
 Offset 0 V

Channel 2

Mode Normal
 Display Off
 Volts/Div 500 mV
 Offset 1.25 V

Delta V

VMarkers On/Chan1
 Marker 1 Position 0 Volt (To Start)
 Marker 2 Position To Maximum Settled Level

After positioning markers to initial position, press 10%-90%

Delta T

TMarkers On
 Start Marker (see Figure 11) At 10% Level Pulse Crossing
 Stop Marker (see Figure 11) At 90% Level Pulse Crossing

Pulse Modulation Rise and Fall Time (Using an Oscilloscope)

NOTE

Figure 4-11 shows the RF Pulse as displayed on the oscilloscope. The Delta V markers are the approximate 10 and 90% Levels of the pulse envelope. The reading Δt is the Rise Time.

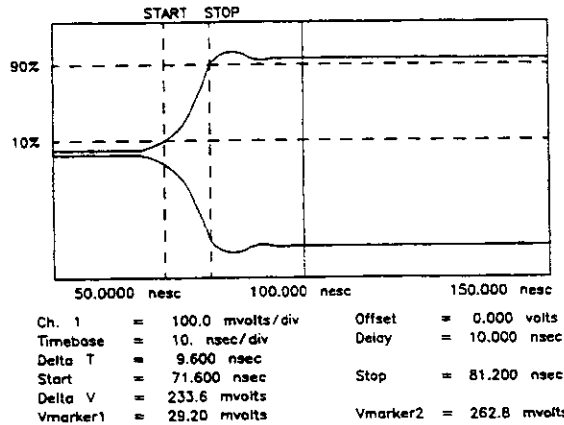

Figure 4-13. Oscilloscope Display

NOTE

If the oscilloscope does not have adequate bandwidth at the higher frequencies, proceed with the following steps using a crystal detector.

- Set the HP 8657B to the frequencies shown in the following Table. For each frequency measure the 10% to 90% Rise Time of the RF Pulse. The Delta V and Delta T Markers will require repositioning after each frequency change. To measure Fall Time will require a Shift Delay of +10 usec minimum on the oscilloscope to view the trailing edge of the pulse (including markers). Refer to Figure 4-13 for an example of the oscilloscope measurement display. The Rise and Fall Time should be within the limits shown in the Table.

Frequency MHz	Results		
	Rise Time Actual	Fall Time Actual	Max
100	_____	_____	<35 ns
300	_____	_____	<35 ns
500	_____	_____	<35 ns
1100	_____	_____	<50 ns

Pulse Modulation Rise and Fall Time (Using a Crystal Detector)

Additional Equipment

Crystal Detector (Negative)	HP 423A
Crystal Detector (Positive)	HP 423A Opt. 003
Power Splitter	HP 11667A
15 MHz Low Pass Filter (2 Required)	(See Figure 4-15)

36. Connect the equipment as shown in Figure 4-14. Low Pass Filters can be constructed using the schematic in Figure 4-15.
37. Set the HP 8657B to the frequencies shown in the Table. For each frequency measure the 10 % and 90 % Rise and Fall Times of the RF Pulse. The waveform on the oscilloscope now is the peak-detected envelope . The Rise and Fall Time should be within the limits shown in the Table. The oscilloscope setups are the same as in step 34.

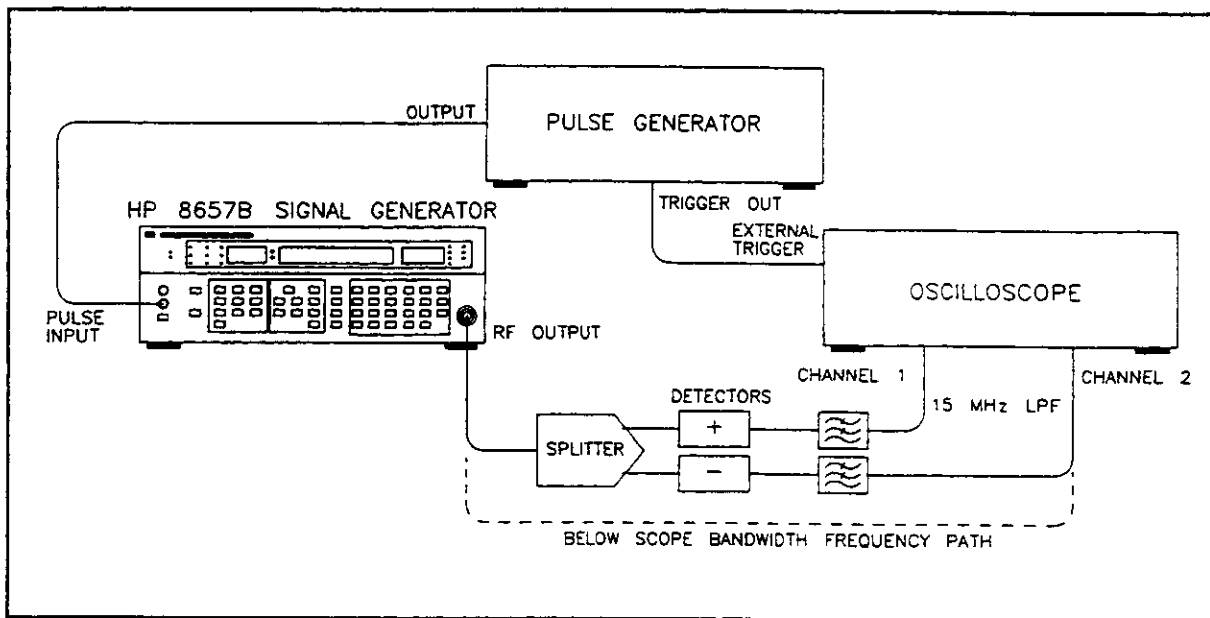

Figure 4-14. Rise/Fall Time Test Setup with Peak Detectors

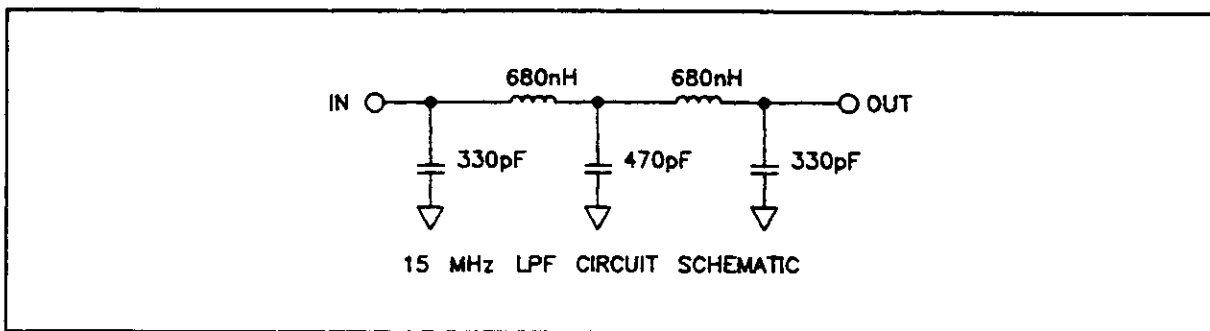

Figure 4-15. Schematic for 15 MHz Low Pass Filters

Pulse Modulation ON/OFF Ratio

38. Set the HP 8657B as follows:

Frequency..... See Table
 Amplitude..... 0 dBm
 Modulation..... Pulse

39. Connect the equipment as shown in Figure 4-16.

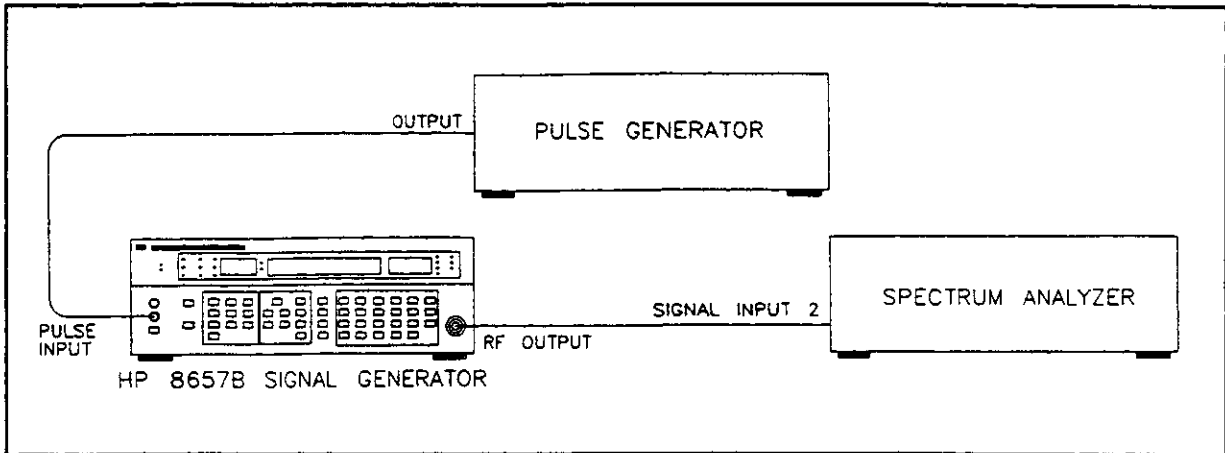

Figure 4-16. Pulse On/Off Ratio Test Setup

40. Set the pulse generator as follows:

Mode Normal
 Frequency..... 100 Hz
 Duty Cycle..... 50%
 Amplitude..... 1 Volt
 Offset..... 1 Volt

41. Set the spectrum analyzer as follows:

Center Frequency..... See Table
 Resolution BW..... 10 kHz
 Video BW..... 1 MHz
 Frequency Span..... 0 Hz
 Reference Level..... 0 dBm
 Reference Level/div..... 10 dB/div
 Trigger..... Video

42. Set the HP 8657B's frequency and the spectrum analyzer's center frequency to the frequencies shown in the following Table. For each frequency measure the change in amplitude as the HP 8657B is pulsed on and off. The amplitude should drop at least 70 dB for frequencies below 1030 MHz and 95 dB for frequencies above 1030 MHz as the HP 8657B is pulsed on and off.

Frequency MHz	Results	
	On/Off Ratio Actual	Min
100	_____	>70 dB
300	_____	>70 dB
500	_____	>70 dB
1100	_____	>95 dB

Performance Test 4

OUTPUT LEAKAGE TESTS

Specification

Leakage limits are within those specified in MIL STD 461B, and FTZ 1115. Furthermore, less than $1.0 \mu\text{V}$ is induced in a two-turn, 2.5 cm (1 inch) diameter loop held 2.5 cm (1 inch) away from the front surface and measured into a 50Ω receiver.

Description

Output leakage is verified by holding a loop antenna 2.5 cm (1 inch) from the front surface of the Signal Generator and measuring the resulting signal with a spectrum analyzer.

The loop antenna is suspended in a molding so that when the molding is in contact with a surface, the loop antenna is one inch from the surface.

NOTE

The use of a screen room may be necessary to reduce external radiated interference.

Equipment

One-Inch Loop Antenna	HP 08640-60501
26 dB Amplifier	HP 8447D
Spectrum Analyzer	HP 8562B
50Ω Termination	HP 908A

Procedure

1. Connect equipment as shown in Figure 4-17, for the signal path shown as 1-4 below.

NOTE

To avoid disturbing the antenna's field and causing measurement error, grasp the antenna at the end that has the BNC connector.

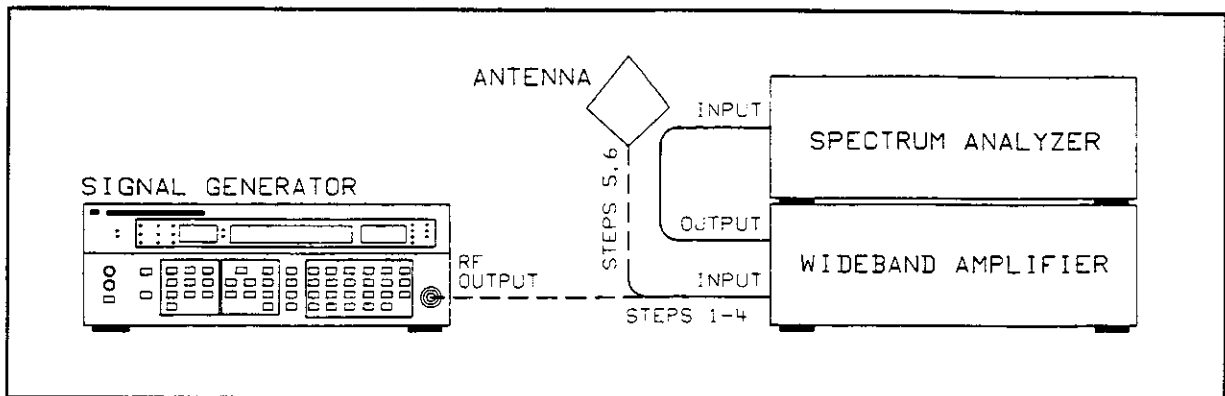

Figure 4-17. Output Leakage Test Setup

2. Set the Signal Generator as follows:

Frequency..... 100 MHz
 Amplitude..... -107 dBm
 Modulation..... Off

3. Set the spectrum analyzer as follows:

Center Frequency 100 MHz
 Input Attenuation -40 dB
 Reference Level -20 dBm
 Frequency Span 20 MHz
 Resolution Bandwidth 10 kHz

4. View the signal on the spectrum analyzer and adjust the reference level controls of the spectrum analyzer to set the amplified -107 dBm signal from the Signal Generator to a reference graticule line on the spectrum analyzer display. Set the video filter to further separate the signal from the noise. Disconnect the Signal Generator from the amplifier, and connect a 50 ohm termination to the Signal Generator's RF OUTPUT connector.

5. Connect the one-inch loop antenna to the analyzer through the amplifier as shown in Figure 4-17, for the signal path shown as 5,6. Hold the end of the loop antenna cylinder in contact with the front surfaces of the Signal Generator. All signals and noise should be below the reference graticule line (i.e.,below -107 dBm).

_____ < -107 dBm (<1.0 μV) at 100 MHz

6. Repeat step 5 for frequencies of 300, 500, 700, 900, 990, 1030 (except HP 8656B), 1040 (except HP 8656B), 2060 MHz (HP 8657B only).

_____ < -107 dBm (<1.0 μV) at 300 MHz

_____ < -107 dBm (<1.0 μV) at 500 MHz

_____ < -107 dBm (<1.0 μV) at 700 MHz

_____ < -107 dBm (<1.0 μV) at 900 MHz

_____ < -107 dBm (<1.0 μV) at 990 MHz

_____ < -107 dBm (<1.0 μV) at 1030 MHz

_____ < -107 dBm (<1.0 μV) at 1040 MHz

_____ < -107 dBm (<1.0 μV) at 2060 MHz

Performance Test 5

SWR TEST (HP 8656B AND HP 8657A ONLY)

NOTE

The SWR specification is a supplemental characteristic for the HP 8657B. The specification in the table below is for the HP 8656B and HP 8657A.

Specification

Electrical Characteristics	Performance Limits	Conditions
SWR:		
RF OUTPUT	< 2.0, -9.6 dB Return Loss	≥ -3.5 dBm
	< 1.5, -14 dB Return Loss	< -3.5 dBm
Impedance	50 ohms nominal	
Reverse Power (HP 8656B)	25 watts	RF power to 990 MHz into RF OUTPUT, dc voltage cannot exceed 25V.
Reverse Power (HP 8657A)	50 watts	RF power to 1040 MHz into RF OUTPUT, dc voltage cannot exceed 50V.

Description

SWR is verified by comparing the reflected power (frequencies 0.5 to 990 MHz for an HP 8656B or 0.5 to 1040 MHz for an HP 8657A from an RF signal source) to a reference that represents 100% return loss. The reference level is determined by disconnecting the SWR bridge from the Signal Generator under test, and connecting a short to the SWR bridge (100% reflected power) to the spectrum analyzer. The reference is established on the spectrum analyzer display. The SWR bridge is then connected to the Signal Generator under test, and return loss for the frequency is displayed on the spectrum analyzer. The output frequency of Signal Generator under test must be set 100 MHz from the frequency of the RF signal source.

Equipment

RF Signal Source HP 8657B
 Spectrum Analyzer HP 8562B
 SWR Bridge Wiltron 60N50
 Cables (UG-21D/U type N connectors) HP 11500B (2 Required)

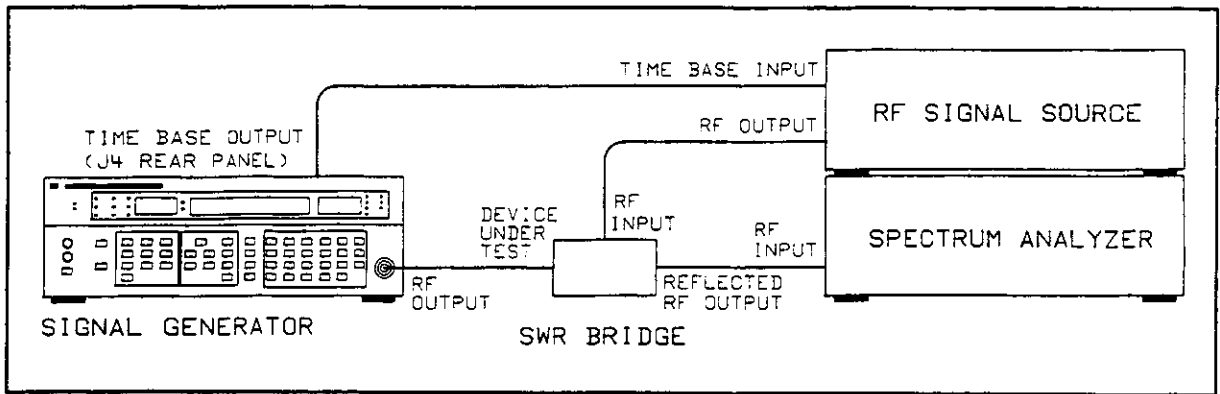

Figure 4-18. SWR Performance Test Setup (Out of Band)

Procedure

≤ -3.5 dBm (10 dB Attenuator Pad Selected)

1. Set the Signal Generator as follows:

Frequency.....0.1 MHz
 Modulation.....Off
 Amplitude.....-10 dBm

2. Set the spectrum analyzer as follows:

Frequency Span 100 MHz
 Resolution Bandwidth 300 kHz
 Reference Level 0 dBm
 Center Frequency 100 MHz

3. Set the RF signal source as follows:

Output Level +10 dBm
 Frequency..... 100 MHz

4. Connect the equipment as shown in Figure 4-18.

5. With the SWR bridge disconnected from the Signal Generator under test, and a short connected to the SWR bridge, set the reference level on the spectrum analyzer for a 100% reflected signal.

6. Connect the SWR bridge to the Signal Generator's RF OUTPUT connector. The difference, in dB, of the level on the display and the reference is the return loss of the Signal Generator's RF OUTPUT connector. The return loss must be >14 dB.

_____ 14 dB

7. Repeat steps 3 through 6 with the RF signal source set to any frequency between 5 MHz and 990 MHz (for an HP 8656B) or 1040 MHz (for an HP 8657A) and 100 MHz from the Signal Generator's frequency.

_____ 14 dB

SWR Test > -3.5 dBm (Attenuator Pads Not Selected)

SWR, without any attenuation, is verified by the following procedure. Set the amplitude of the Signal Generator under test and turn off the RF signal source. Then the amplitude of the reflected signal from the RF source is set to an equal level with the Device Under Test port shorted. The maximum and minimum voltages in dB are read from the spectrum analyzer to compute the SWR using the equation listed below.

8. Set the Signal Generator as follows:

Frequency 100 MHz
 Modulation Off
 Amplitude -2 dBm

9. Set the spectrum analyzer as follows:

Frequency Span 0 Hz
 Resolution Bandwidth 3 MHz
 Reference Level 0 dBm
 Center Frequency 100 MHz
 Scale LOG 2dB/Div

10. Set the RF signal source as follows:

Amplitude -127 dBm
 Modulation Off
 Frequency 100 MHz
 RF Off

11. Connect the equipment as shown in Figure 4-18.

12. With the SWR bridge connected to the Signal Generator under test, and the amplitude of the RF signal source turned off, set a reference on the spectrum analyzer. Tune the frequency of the spectrum analyzer for maximum level on the display.

13. Disconnect the SWR bridge from the Signal Generator under test and connect a short to the Device Under Test port.

14. Set the amplitude of the RF signal source to +13 dBm.

15. Set the amplitude of the RF signal source to the same level on the spectrum analyzer as set in step 12.

16. Remove the short from the SWR bridge, and connect the SWR bridge to the Signal Generator under test.

17. Press and release the Blue SHIFT key. Press and hold the Phase Decrement DOWN key (frequency decrement DOWN key). The level on the spectrum analyzer changes as the phase changes.

NOTE

Each time the Phase Decrement key is released, the SHIFT key must be pressed to reselect the Phase Decrement function.

18. Read the maximum and minimum power levels from the spectrum analyzer and substitute their value in the following equation and solve for the SWR of the Signal Generator.

_____ <2.0

19. Repeat steps 8 through 18 for each frequency between 5 and 990 MHz (for an HP 8656B) or 1040 MHz (for an HP 8657A) at which SWR is to be checked.

$$SWR = \frac{1 + \rho}{1 - \rho} = \frac{E_{max}}{E_{min}}$$

$$E_{max} = A + \rho A$$

$$E_{min} = A - \rho A$$

$$SWR = \frac{E_{max}/A}{E_{min}/A} = \frac{E_{max}}{E_{min}}$$

$$20 \log E_{max} = E_{max} \text{ dB}$$

$$20 \log E_{min} = E_{min} \text{ dB}$$

$$20 \log SWR = 20 \log \frac{(E_{max})}{(E_{min})}$$

$$20 \log SWR = 20 \log E_{max} - 20 \log E_{min}$$

$$20 \log SWR = E_{max} \text{ dB} - E_{min} \text{ dB}$$

$$SWR = 10^{\frac{E_{max} \text{ dB} - E_{min} \text{ dB}}{20}}$$

Performance Test Record

SPECTRAL PURITY TESTS

Spurious Signals

Spurious Signals	Results			
	Actual	HP 8656B	HP 8657A	HP 8657B
Harmonics	_____	< -30 dBc	< -30 dBc	< -30 dBc (0.1 to 1030MHz) < -25 dBc (1030 to 2060MHz)
Non-Harmonics (≥ 2 MHz from carrier)	_____	< -60 dBc	< -60 dBc	< -60 dBc (0.1 to 1030MHz) < -54 dBc (1030 to 2060 MHz)
5 kHz to 2 MHz from carrier	_____	< -60 dBc	< -60 dBc (0.1 to 130MHz)	< -63 dBc (0.1 to 130MHz)
	_____		< -72 dBc (130 to 260MHz)	< -75 dBc (130 to 260MHz)
	_____		< -66 dBc (260 to 520MHz)	< -66 dBc (260 to 520MHz)
	_____		< -60 dBc, 520 to 1040MHz	< -63 dBc (520 to 1030MHz) < -57 dBc (1030 to 2060 MHz)
Sub-Harmonics	_____	None	None	None, 0.1 to 1030 MHz < -40 dBc (1030 to 1800 MHz) < -35 dBc (1800 to 2060 MHz)

Residual AM

The digital multimeter should indicate <1.77 mVrms for an HP 8656B.

The digital multimeter should indicate <3.28 mVrms for an HP 8657A or HP8657B.

Actual	Maximum
_____	< 1.77 mVrms
_____	< 3.28 mVrms

Residual FM

Signal Generator Frequency (MHz)	Modulation Analyzer Filter		Results (Hz rms)	
	High Pass (Hz)	Low Pass (kHz)	Actual	Max.
0.15 to 123.00000	300	3	_____	< 4
0.15 to 123.00000	50	15	_____	< 6

Optional Residual FM Test

Optional Residual FM Test Specifications

Test Signal Generator Frequency (MHz)	LO Signal Generator Frequency (MHz)	Results (Hz rms)					
		HP 8656B		HP 8657A		HP 8657B	
		Actual	Max	Actual	Max	Actual	Max
120	121.5	_____	7	_____	4	_____	4
150	151.5	_____	2	_____	1	_____	1
300	301.5	_____	4	_____	2	_____	2
600	601.5	_____	7	_____	4	_____	3
1300	1301.5	N/A	N/A	N/A	N/A	_____	6

SSB Phase Noise for HP 8656B

Offset from Carrier	HP 8656B SSB Phase Noise		Carrier Frequency (MHz)
	Min.	Actual	
20 kHz	-114 dBc/Hz	_____	0.1 to 123.5
	-126 dBc/Hz	_____	123.5 to 247
	-120 dBc/Hz	_____	247 to 494
	-114 dBc/Hz	_____	494 to 990

SSB Phase Noise for HP 8657A

Offset from Carrier	HP 8657A SSB Phase Noise		Carrier Frequency (MHz)
	Min.	Actual	
20 kHz	-124 dBc/Hz	_____	0.1 to 130
	-136 dBc/Hz	_____	130 to 260
	-130 dBc/Hz	_____	260 to 520
	-124 dBc/Hz	_____	520 to 1040

SSB Phase Noise for HP 8657B

Offset from Carrier	SSB Phase Noise		Carrier Frequency (MHz)
	Min.	Actual	
20 kHz	-124 dBc/Hz	_____	0.1 to 129
	-136 dBc/Hz	_____	130 to 260
	-130 dBc/Hz	_____	260 to 520
	-124 dBc/Hz	_____	520 to 1040
	-118 dBc/Hz	_____	1040 to 1600

Absolute Level Accuracy

RF Output Test Frequency 1 _____
 RF Output Test Frequency 2 _____

RF Output Test Frequency 3 _____
 RF Output Test Frequency 4 _____

All Models	HP 8656B Only (100 kHz to 123.5 MHz)				HP 8656B (> 123.5 MHz), HP 8657A, HP 8657B				
	Amplitude Setting (dBm)	Minimum (dBm)	Maximum (dBm)	Actual (dBm)		Minimum (dBm)	Maximum (dBm)	Actual (dBm)	
				Freq 1	Freq 2			Freq 3	Freq 4
+13.0 ¹	+11.5	+14.5	_____	_____	+11.5	+14.5	_____	_____	
+8.0	+6.5	+9.5	_____	_____	+6.5	+9.5	_____	_____	
+3.0	+1.5	+4.5	_____	_____	+2.0	+4.0	_____	_____	
-2.0	-3.5	-0.5	_____	_____	-3.0	-1.0	_____	_____	
-7.0	-8.5	-5.5	_____	_____	-8.0	-6.0	_____	_____	
-12.0	-13.5	-10.5	_____	_____	-13.0	-11.0	_____	_____	
-17.0	-18.5	-15.5	_____	_____	-18.0	-16.0	_____	_____	
-22.0	-23.5	-20.5	_____	_____	-23.0	-21.0	_____	_____	
-27.0	-28.5	-25.5	_____	_____	-28.0	-26.0	_____	_____	
-32.0	-33.5	-30.5	_____	_____	-33.0	-31.0	_____	_____	
-37.0	-38.5	-35.5	_____	_____	-38.0	-36.0	_____	_____	
-42.0	-43.5	-40.5	_____	_____	-43.0	-41.0	_____	_____	
-47.0	-48.5	-45.5	_____	_____	-48.0	-46.0	_____	_____	
-52.0	-53.5	-50.5	_____	_____	-53.0	-51.0	_____	_____	
-57.0	-58.5	-55.5	_____	_____	-58.0	-56.0	_____	_____	
-62.0	-63.5	-60.5	_____	_____	-63.0	-61.0	_____	_____	
-67.0	-68.5	-65.5	_____	_____	-68.0	-66.0	_____	_____	
-72.0	-73.5	-70.5	_____	_____	-73.0	-71.0	_____	_____	
-77.0	-78.5	-75.5	_____	_____	-78.0	-76.0	_____	_____	
-82.0	-83.5	-80.5	_____	_____	-83.0	-81.0	_____	_____	
-87.0	-88.5	-85.5	_____	_____	-88.0	-86.0	_____	_____	
-92.0	-93.5	-90.5	_____	_____	-93.0	-91.0	_____	_____	
-97.0	-98.5	-95.5	_____	_____	-98.0	-96.0	_____	_____	
-102.0	-103.5	-100.5	_____	_____	-103.0	-101.0	_____	_____	
-107.0	-108.5	-105.5	_____	_____	-108.0	-106.0	_____	_____	
-112.0	-113.5	-110.5	_____	_____	-113.0	-111.0	_____	_____	
-117.0	-118.5	-115.5	_____	_____	-118.0	-116.0	_____	_____	
-122.0	-123.5	-120.5	_____	_____	-123.0	-121.0	_____	_____	
-127.0	-128.5	-125.5	_____	_____	-128.0 ²	-126.0 ²	_____	_____	
-127.0	-128.5	-125.5	_____	_____	-128.5 ³	-125.5 ³	_____	_____	

¹ +13.0 dBm does not apply to HP 8657B with Pulse Modulation installed.
² HP 8657A and HP 8657B only.
³ HP 8656B only < - 124.0 dBm.

AC MODULATION

AM Indicator Accuracy ... 1 kHz (Int)

MHz	AM Depth	Results				
		Min.		Actual	Max.	
		HP 8656B	HP8657A HP8657B		HP 8656B	HP 8657A HP 8657B
100	10%	7.6%	7.4%	_____	12.4%	12.6%
	30%	26.8%	26.2%	_____	33.2%	33.8%
	70%	65.2%	63.8%	_____	74.8%	76.2%
	90%	84.4%	82.6%	_____	95.6%	97.4%
240	10%	7.6%	7.4%	_____	12.4%	12.6%
	30%	26.8%	26.2%	_____	33.2%	33.8%
	70%	65.2%	63.8%	_____	74.8%	76.2%
	90%	84.4%	82.6%	_____	95.6%	97.4%
400	10%	7.6%	7.4%	_____	12.4%	12.6%
	30%	26.8%	26.2%	_____	33.2%	33.8%
	70%	65.2%	63.8%	_____	74.8%	76.2%
	90%	84.4%	82.6%	_____	95.6%	97.4%
990	10%	7.6%	7.4%	_____	12.4%	12.6%
	30%	26.8%	26.2%	_____	33.2%	33.8%
	70%	65.2%	63.8%	_____	74.8%	76.2%
	90%	84.4%	82.6%	_____	95.6%	97.4%
1030 (HP 8657A & HP 8657B only)	10%	N/A	7.4%	_____	N/A	12.6%
	30%		26.2%	_____		33.8%
	70%		63.8%	_____		76.2%
	90%		82.6%	_____		97.4%
1040 (HP 8657A & HP 8657B only)	10%	N/A	7.4%	_____	N/A	12.6%
	30%		26.2%	_____		33.8%
	70%		63.8%	_____		76.2%
	90%		82.6%	_____		97.4%
1300 (HP 8657B only)	10%	N/A	7.4%	_____	N/A	12.6%
	30%		26.2%	_____		33.8%
	70%		63.8%	_____		76.2%
	90%		82.6%	_____		97.4%

AM Indicator Accuracy ... 400 Hz (Int)

MHz	AM Depth	Results				
		Min.		Actual	Max.	
		HP 8656B	HP8657A HP8657B		HP 8656B	HP 8657A HP 8657B
100	10%	7.6%	7.4%	_____	12.4%	12.6%
	30%	26.8%	26.2%	_____	33.2%	33.8%
	70%	65.2%	63.8%	_____	74.8%	76.2%
	90%	84.4%	82.6%	_____	95.6%	97.4%

Incidental Phase Modulation

Model	Frequency		Result	
	Min.	Max.	Actual	Max.
HP 8656B	150 kHz	990 MHz	_____	< 0.3 radian peak
HP 8657A	150 kHz	1040 MHz	_____	< 0.3 radian peak
HP 8657B	150 kHz	1300 MHz	_____	< 0.3 radian peak

AM Distortion

MHz	AM Depth	Results			
		Actual	Max.		
			HP 8656B	HP 8657A	HP 8657B
100	30%	_____	< 1.5%	< 1.5%	< 1.5% ⁽¹⁾
	70%	_____	< 3.0%	< 3.0%	< 3.0% ⁽¹⁾
	90%	_____	< 4.0%	< 4.0%	< 4.0%
240	30%	_____	< 1.5%	< 1.5%	< 1.5% ⁽¹⁾
	70%	_____	< 3.0%	< 3.0%	< 3.0% ⁽¹⁾
	90%	_____	< 4.0%	< 4.0%	< 4.0%
400	30%	_____	< 1.5%	< 1.5%	< 1.5% ⁽¹⁾
	70%	_____	< 3.0%	< 3.0%	< 3.0% ⁽¹⁾
	90%	_____	< 4.0%	< 4.0%	< 4.0%
990	30%	_____	< 1.5%	< 1.5%	< 1.5% ⁽¹⁾
	70%	_____	< 3.0%	< 3.0%	< 3.0% ⁽¹⁾
	90%	_____	< 4.0%	< 4.0%	< 4.0%
1030	30%	_____	N/A	< 1.5%	< 4.0%
	70%	_____		< 3.0%	< 4.0%
	90%	_____		< 4.0%	< 7.0%
1040	30%	_____	N/A	< 1.5%	< 4.0%
	70%	_____		< 3.0%	< 4.0%
	90%	_____		< 4.0%	< 7.0%
1300	30%	_____	N/A	N/A	< 4.0%
	70%	_____			< 4.0%
	90%	_____			< 7.0%

(1) When Opt 003 is installed, AM Depth at 70% ($f_c < 1030$ MHz) is < 4%

FM Indicator Accuracy

FM Deviation for 100 MHz	Results		
	Min.	Actual	Max.
5.0 kHz	4.75 kHz	_____	5.25 kHz
30.0 kHz	28.50 kHz	_____	31.50 kHz
70.0 kHz	66.50 kHz	_____	73.50 kHz
99.0 kHz	94.05 kHz	_____	103.95 kHz

Incidental AM

Model	Frequency		Result	
	Min.	Max.	Actual	Max.
HP 8656B	10 MHz	990 MHz	_____	< 0.1%
HP 8657A	10 MHz	1040 MHz	_____	< 0.1%
HP 8657B	10 MHz	1030 MHz	_____	< 0.1%
	1030 MHz	1300 MHz	_____	< 0.5%

FM Distortion

Model	FM Deviation		Result	
	Min.	Max.	Actual	Max.
HP 8656B	3 kHz	99 kHz	_____	<0.5%
HP 8657A	6 kHz	99 kHz	_____	<0.5%
HP 8657B	6 kHz	99 kHz	_____	<0.5%

DC MODULATION

DC FM Center Frequency Accuracy And Stability

Model	Frequency (MHz)	DC FM Deviation (kHz)	Accuracy	Stability
			Offset (kHz)	Drift (Hz/Hr)
HP 8656B	0.1 to 123.5	1 to 99	_____ ± 500 Hz	_____ ± 10
	123.5 to 247	1 to 50	_____ ± 125 Hz	_____ ± 10
	247 to 494	1 to 99	_____ ± 250 Hz	_____ ± 10
	494 to 990	1 to 99	_____ ± 500 Hz	_____ ± 10
HP 8657A and HP 8657B	0.1 to 130	1 to 99	_____ ± 500 Hz	_____ ± 10
	130 to 269	1 to 50	_____ ± 125 Hz	_____ ± 10
	260 to 520	1 to 99	_____ ± 250 Hz	_____ ± 10
HP 8657A	520 to 1040	1 to 99	_____ ± 500 Hz	_____ ± 10
HP 8657B	520 to 1030	1 to 99	_____ ± 500 Hz	_____ ± 10
	1030 to 2060	1 to 99	_____ ± 1000 Hz	_____ ± 10

Pulse Modulation Rise and Fall Time (HP 8657B Only)

Frequency MHz	Results		
	Rise Time Actual	Fall Time Actual	Max
100	_____	_____	<35 ns
300	_____	_____	<35 ns
500	_____	_____	<35 ns
1100	_____	_____	<40 ns

Pulse Modulation ON/OFF Ratio (HP 8657B Only)

Frequency MHz	Results	
	On/Off Ratio Actual	Min
100	_____	>70 dB
300	_____	>70 dB
500	_____	>70 dB
1100	_____	>95 dB

OUTPUT LEAKAGE TESTS

Test for frequency of 100 MHz.

_____ < -107 dBm (<1.0 μ V) at 100 MHz

Test for frequencies of 300, 500, 700, 900, 990, 1030 (except HP 8656B), 1040 (except HP 8657A) and 2060 MHz (HP 8657B only).

_____ < -107 dBm (<1.0 μ V) at 300 MHz

_____ < -107 dBm (<1.0 μ V) at 500 MHz

_____ < -107 dBm (<1.0 μ V) at 700 MHz

_____ < -107 dBm (<1.0 μ V) at 900 MHz

_____ < -107 dBm (<1.0 μ V) at 990 MHz

_____ < -107 dBm (<1.0 μ V) at 1030 MHz

_____ < -107 dBm (<1.0 μ V) at 1040 MHz

_____ < -107 dBm (<1.0 μ V) at 2060 MHz

SWR TEST

≤ -6.5 dBm (10 dB Attenuator Pad Selected)

Test for frequency of .1 MHz (100 MHz from carrier).

_____ > 14 dBm

Test for frequencies of between 5 MHz and 990 MHz (for an HP 8656B) or 1040 MHz (for an HP 8657A).

_____ > 14 dBm

> -6.5 dBm (Attenuator Pads Not Selected)

Test for frequency of 100 MHz .

_____ < 2 dBm

Section 5 ADJUSTMENTS

5-1. INTRODUCTION

This section contains adjustments and checks that assure peak performance of the Signal Generator. The Signal Generator should be readjusted after repair or failure to pass a performance test. Allow a 30-minute warm-up prior to performing the adjustments. Removal of the Signal Generator top and bottom covers is required for most adjustments. Included in this section are test setups and diagrams that show the location of each assembly. Adjustment location diagrams and removal and disassembly instructions are provided at the end of this section. To determine which performance tests and adjustments to perform after a repair, refer to Table 5-2, Post-Repair Adjustments.

5-2. SAFETY CONSIDERATIONS

Refer to the Safety Considerations page found at the beginning of this manual for a summary of the safety information.

5-3. EQUIPMENT REQUIRED

All adjustment procedures contain a list of required test equipment. The test equipment is also identified by callouts in the test setup diagrams, where included. If substitutions must be made for the specified test equipment, refer to the Recommended Test Equipment table in Section 1 of this manual for the minimum specifications. It is important that the test equipment meet the critical specifications listed in the table if the Signal Generator is to meet its performance requirements.

5-4. FACTORY-SELECTED COMPONENTS

Factory-selected components are identified on the schematics and parts lists by asterisk (*) which follows the reference designator. The nominal value or range of the components is shown. Manual Update addition and replacement pages provide updated information pertaining to selected components. Table 5-1 lists the reference designator, the basis used for selecting a particular value, the nominal value range, and the service sheet where the component part is shown.

5-5. POST-REPAIR ADJUSTMENTS

Table 5-2 lists the adjustments related to repairs or replacement of any of the assemblies.

5-6. RELATED ADJUSTMENTS

The procedures in this section can be done in any order; however, it is suggested that the power supply voltage, reference voltage, and audio oscillator adjustments be performed first. Changes in these adjustments can affect other adjustments, especially level and modulation accuracies.

WARNING

Maintenance described herein is performed with power supplied to the instrument, and protective covers removed. Such maintenance should be performed only by service-trained personnel who are aware of the hazards involved (for example, fire and electrical shock). Where maintenance can be performed without power applied, the power should be removed.

Table 5-1. Factory Selected Components

Model	Reference Designator	Service Sheet	Range of Values	Basis of Selection																																																		
56B 57A 57B	A3C23	16	33 pF to 47 pF	Select capacitor so that the output level of the 50 MHz Reference Oscillator can be adjusted to greater than +17 dBm.																																																		
	A3L6	16	680 nH or 470 nH	Select inductor so that the 50 MHz crystal can be tuned to 50 MHz ± 1250 Hz using an external reference.																																																		
	A3R303	11	3.16k to 4.64k	Nominal value 3.16k. Select alternate values (3.48k or 4.64k) to insure correct operation of Fractional-N IC (A3U17).																																																		
	A4R6, 7, 10	1	See table under "Basis of Selection"	Attenuator pad selected for -8 dBm input to mixer A4U1. Measure power level at RF Test Point A4TP3 as described in Adjustment 9. Select pad values for -8 dBm to mixer. Level must be checked whenever the A3A1, A4, A8, or FL1 assemblies are replaced. <table border="1" data-bbox="711 688 1458 1108"> <thead> <tr> <th>Attenuation (dB)</th> <th>R6, R10 (ohms)</th> <th>HP Part No. (Check Digit)</th> <th>R7 (ohms)</th> <th>HP Part No. (Check Digit)</th> </tr> </thead> <tbody> <tr> <td>2</td> <td>422</td> <td>0698-7227 (6)</td> <td>10</td> <td>0698-7189 (9)</td> </tr> <tr> <td>3</td> <td>287</td> <td>0698-7223 (2)</td> <td>17.8</td> <td>0698-7194 (6)</td> </tr> <tr> <td>4</td> <td>215</td> <td>0698-7220 (9)</td> <td>23.7</td> <td>0698-7197 (9)</td> </tr> <tr> <td>5</td> <td>178</td> <td>0698-7218 (5)</td> <td>31.6</td> <td>0698-7200 (5)</td> </tr> <tr> <td>6</td> <td>147</td> <td>0698-7216 (3)</td> <td>38.3</td> <td>0698-7202 (7)</td> </tr> <tr> <td>7</td> <td>133</td> <td>0698-7215 (2)</td> <td>46.4</td> <td>0698-7204 (9)</td> </tr> <tr> <td>8</td> <td>121</td> <td>0698-7214 (1)</td> <td>51.1</td> <td>0698-7205 (0)</td> </tr> <tr> <td>9</td> <td>110</td> <td>0698-7213 (0)</td> <td>61.9</td> <td>0698-7207 (2)</td> </tr> <tr> <td>10</td> <td>100</td> <td>0698-7212 (9)</td> <td>75.0</td> <td>0698-7209 (4)</td> </tr> </tbody> </table>	Attenuation (dB)	R6, R10 (ohms)	HP Part No. (Check Digit)	R7 (ohms)	HP Part No. (Check Digit)	2	422	0698-7227 (6)	10	0698-7189 (9)	3	287	0698-7223 (2)	17.8	0698-7194 (6)	4	215	0698-7220 (9)	23.7	0698-7197 (9)	5	178	0698-7218 (5)	31.6	0698-7200 (5)	6	147	0698-7216 (3)	38.3	0698-7202 (7)	7	133	0698-7215 (2)	46.4	0698-7204 (9)	8	121	0698-7214 (1)	51.1	0698-7205 (0)	9	110	0698-7213 (0)	61.9	0698-7207 (2)	10	100	0698-7212 (9)	75.0	0698-7209 (4)
	Attenuation (dB)	R6, R10 (ohms)	HP Part No. (Check Digit)	R7 (ohms)	HP Part No. (Check Digit)																																																	
	2	422	0698-7227 (6)	10	0698-7189 (9)																																																	
	3	287	0698-7223 (2)	17.8	0698-7194 (6)																																																	
	4	215	0698-7220 (9)	23.7	0698-7197 (9)																																																	
	5	178	0698-7218 (5)	31.6	0698-7200 (5)																																																	
	6	147	0698-7216 (3)	38.3	0698-7202 (7)																																																	
7	133	0698-7215 (2)	46.4	0698-7204 (9)																																																		
8	121	0698-7214 (1)	51.1	0698-7205 (0)																																																		
9	110	0698-7213 (0)	61.9	0698-7207 (2)																																																		
10	100	0698-7212 (9)	75.0	0698-7209 (4)																																																		
A8C5	3	47 pF to 82 pF	Select A8C5 to maximize DC voltage measured at J2 pin 4.																																																			
A8C19	3	20 pF to 39 pF	Select A8C19 to maximize DC voltage measured at J2 pin 6.																																																			
A8C40	3	0 or 1000 pF	Selected to eliminate a spurious signal at 700 MHz.																																																			
56B	A5C15	1	10 pF to 33 pF	Decrease the value of C15 if the 494-990 MHz oscillator fails to oscillate at 494 MHz only. Increase C15's value if spurs are present at half the fundamental frequency from 494-990 MHz.																																																		
	A5C22	1	0 or 1 pF	Selected to eliminate spurious signals at 690-740 MHz.																																																		
	A6R57	5	237 Ω to 562 Ω	Resistor A6R57 is selected to center the adjustment range of variable capacitor A6C56, so the RF OUTPUT can be adjusted ± 0.5 dB from 0.0 dBm.																																																		
57A 57B	A4C155	1	10 pF to 33 pF	Decrease the value of C155 if the 520-1040 MHz oscillator fails to oscillate at 520 MHz only. Increase C155's value if spurs are present at half the fundamental frequency from 520-1040 MHz.																																																		
	A6C232	4	0 or 1.8 pF	Removed to eliminate spurs at 1200 to 1400 MHz when the RF OUTPUT is 600 MHz to 700 MHz.																																																		

Table 5-2. Post-Repair Adjustments

Assembly Repaired or Replaced	Model	Related Adjustments
A1	All	None
A2	All	None
A3	All	5,6,7,14,15,17,18,19,20
A3A1	All	7,14,16,17,18
A5	56B	10
A6	All	11,12
A8	All	9,10
A9	All	None
A10	56B,57A	1,2,3,4,11,12,13,19,20,21,22
A10	57B	None
A11	56B,57A	None
A11	57B	2,3,4,11,12,13,19,20,21,22
A12	57B	13
A13	57B	None
A14	57B	1
A15	All	None
A16	All	23
FL1	All	9,10

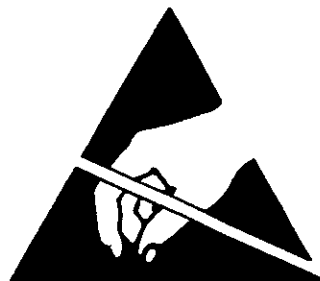

**ATTENTION
Static Sensitive
Devices**

When handling equipment containing static sensitive devices, adequate precautions must be taken to prevent device damage or destruction. Only those who are thoroughly familiar with industry accepted techniques for handling static sensitive devices should attempt to service circuitry with these devices.

Adjustment 1a

HP 8656B POWER SUPPLY VOLTAGE ADJUSTMENTS

- Service Sheets 10 and 25.

Description

The +5.4 Vdc power supply is adjusted for +5.25 Vdc \pm 0.02 Vdc at A10J2 pin 1 using a digital multimeter.

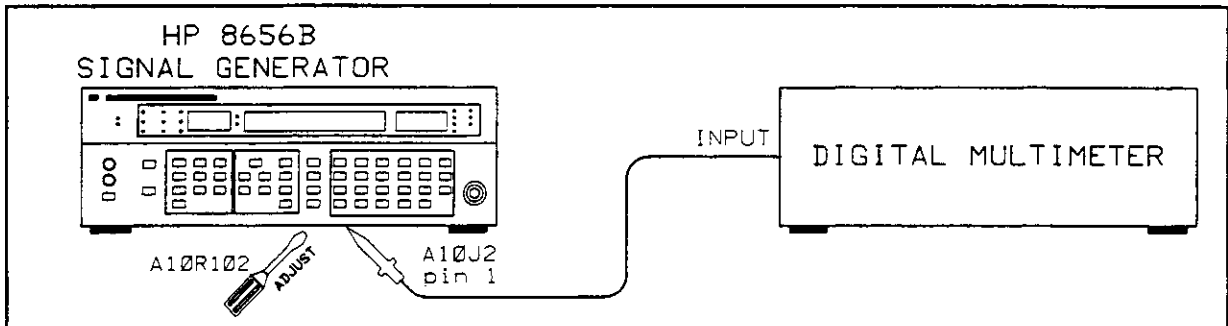

Figure 5-1. HP 8656B Power Supplies Adjustment Setup

Equipment

Digital Multimeter HP 3466A

Procedure

1. Set the digital multimeter as follows:

Function Vdc
Range 20V

2. Preset the HP 8656B by pressing SHIFT and 0.

The front panel will display 100 MHz, -127.0 dBm.

3. Connect the digital multimeter to A10J2 pin 1. Adjust A10R102 (+5.4V ADJ) for a reading of +5.25 Vdc \pm 0.02 Vdc on the digital multimeter.

Adjustment 1b

HP 8657A POWER SUPPLY VOLTAGE ADJUSTMENTS

- Service Sheets 10 and 25.

Description

The +5.4 Vdc power supply is adjusted for +5.4 Vdc at A10J2 pin 10 using a digital multimeter.

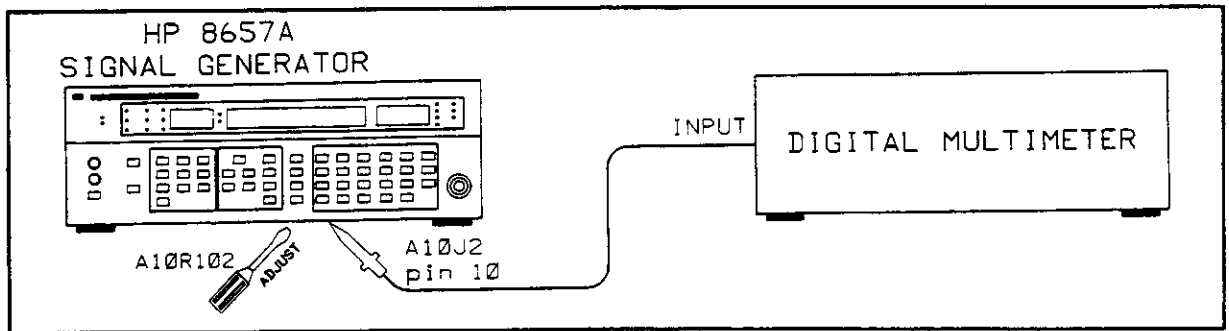

Figure 5-2. HP 8657A Power Supplies Adjustment Setup

Equipment

Digital Multimeter HP 3466A

Procedure

1. Set the digital multimeter as follows:
 - Function Vdc
 - Range 20V
2. Preset the HP 8657A by pressing SHIFT and 0.
The front panel will display 100 MHz, -143.5 dBm.
3. Connect the digital multimeter to A10J2 pin 10. Adjust A10R102 (+5.4V ADJ) for a reading of +5.4 Vdc ±0.02 Vdc on the digital multimeter.

Adjustment 1c

HP 8657B POWER SUPPLY VOLTAGE ADJUSTMENTS

- Service Sheets 10 and 24.

Description

The +5.2, -5.2, +15.0, -15.0, and +38.0 Vdc power supplies are adjusted using a digital multimeter. The +5.2 Vdc power supply is adjusted for +5.2 Vdc \pm 0.02 Vdc at A13J2 pin 1. The -5.2 Vdc power supply is adjusted for -5.2 Vdc \pm 0.02 Vdc at A13J2 pin 2. The +15.0 Vdc power supply is adjusted for +15.0 Vdc \pm 0.1 Vdc at A13J2 pin3. The -15.0 Vdc power supply is adjusted for -15.0 Vdc \pm 0.1 Vdc at A3J2 pin4. The +38 Vdc power supply is adjusted for +38 Vdc \pm 0.3 Vdc at A13J2 pin 5.

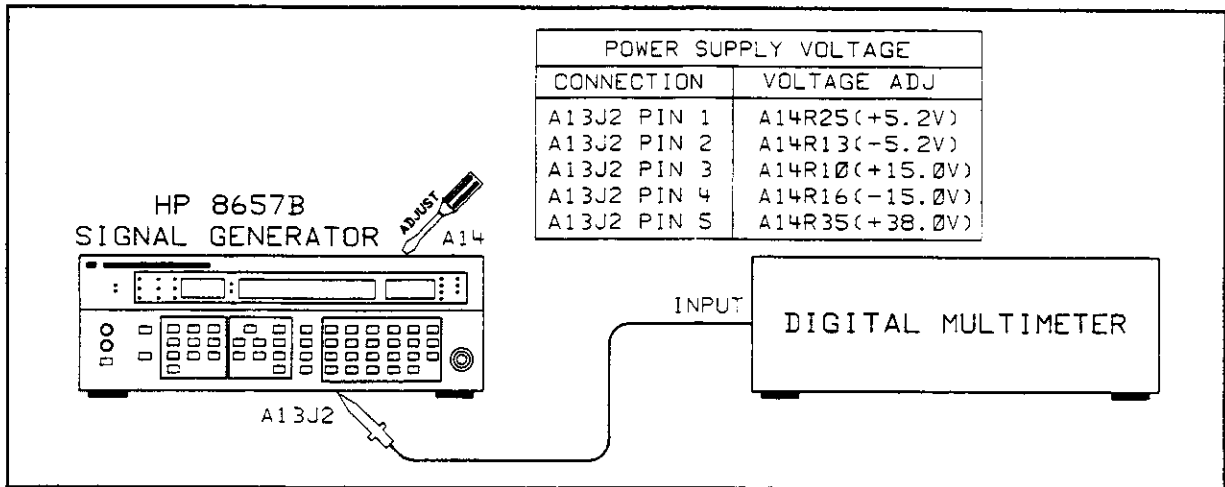

Figure 5-3. Power Supplies Adjustment Setup

Equipment

Digital Multimeter HP 3466A

Procedure

1. Set the digital multimeter as follows:
 - Function Vdc
 - Range..... 20V
2. Preset the HP 8657B by pressing SHIFT and 0.
The front panel will display 100 MHz, -143.5 dBm.
3. Connect the digital multimeter to A13J2 A13J2 pin 1. Adjust A14R25 (+5.2V ADJ) for a reading of +5.2 Vdc \pm 0.02 Vdc on the digital multimeter.
4. Connect the digital multimeter to A13J2 pin 2. Adjust A14R13 (-5.2V ADJ) for a reading of -5.2 Vdc \pm 0.02 Vdc on the digital multimeter.
5. Connect the digital multimeter to A13J2 pin3. Adjust A14R10 (+15.0V ADJ) for a reading of +15.0 Vdc \pm 0.1 Vdc on the digital multimeter.
6. Connect the digital multimeter to A13J2 pin4. Adjust A14R16 (-15.0V ADJ) for a reading of -15.0 Vdc \pm 0.1 Vdc on the digital multimeter.

7. Set digital multimeter Range to 200 V. Connect the digital multimeter to A13J2 pin 5. Adjust A14R35 (+38.0V ADJ) for a reading of +38.0 Vdc \pm 0.3 Vdc on the digital multimeter.

Adjustment 2

REFERENCE VOLTAGE ADJUSTMENT

- Service Sheet 6

Description

The +2 Vdc reference is adjusted for +2.000 Vdc \pm 0.004 Vdc using a digital multimeter.

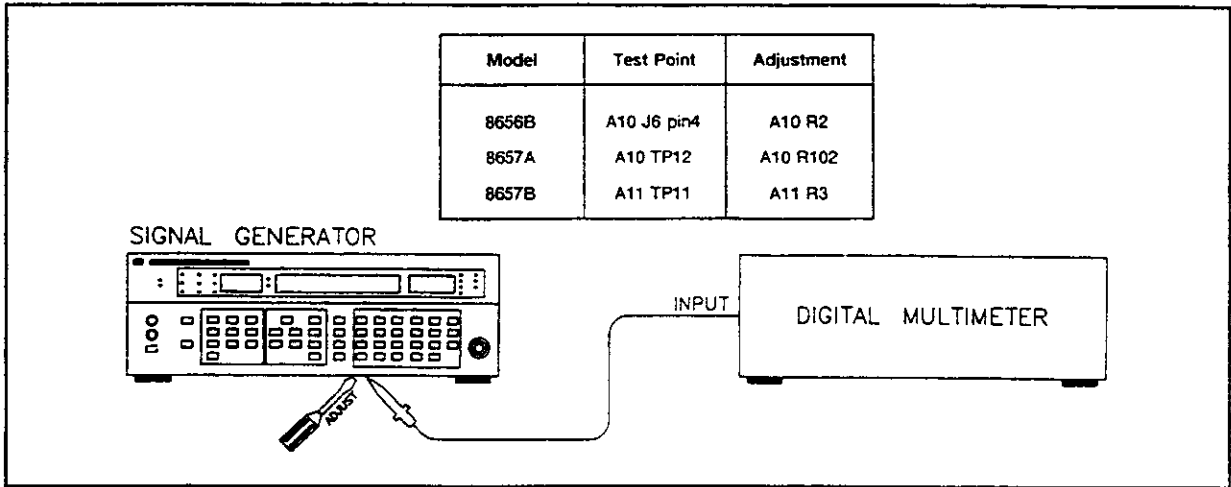

Figure 5-4. +2 Vdc Reference Adjustment Setup

Equipment

Digital Multimeter HP 3466A

Procedure

1. Set the digital multimeter as follows:
 - Function Vdc
 - Range 20V
2. Preset the Signal Generator by pressing SHIFT followed by 0.
3. Connect the digital multimeter to the relevant test point as shown in the table below and adjust for a reading of 2.000 Vdc \pm 0.004 Vdc on the digital multimeter.

Model	Test Point	Adjustment
8656B	A10 J6 pin4	A10 R2
8657A	A10 TP12	A10 R102
8657B	A11 TP11	A11 R3

Adjustment 3

AUDIO OSCILLATOR LEVEL ADJUSTMENT

- Service Sheet 7

Description

The internal 1 kHz modulation source is adjusted to 0.707 Vrms ±0.007 Vrms. Then the internal 400 Hz modulation source is checked to ensure that it is within the same limits.

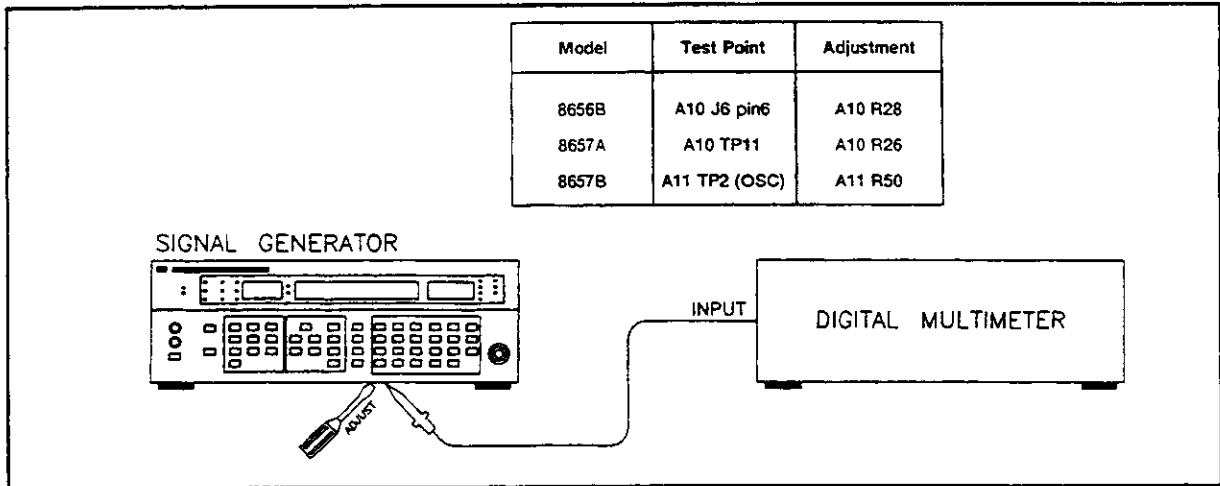

Figure 5-5. Audio Oscillator Level Adjustment Setup

Equipment

Digital Multimeter HP 3466A

Procedure

- Set the digital multimeter as follows:
 - Function Vac
 - Range 2V
- Set the Signal Generator as follows:
 - Frequency Any
 - Amplitude Any
 - Modulation AM
 - Source 1 kHz

3. Connect the digital multimeter to the test points shown in the table below and adjust for a $0.707 \text{ Vrms} \pm 0.007 \text{ Vrms}$ reading on the digital multimeter.
4. Select the internal 400 Hz modulation source. Check that the 400 Hz oscillator level is within $0.707 \text{ Vrms} \pm 0.007 \text{ Vrms}$. If it is not, repeat step 4 until both readings are within the specified limits.

Model	Test Point	Adjustment
8656B	A10 J6 pin6	A10 R28
8657A	A10 TP11	A10 R26
8657B	A11 TP2 (OSC)	A11 R50

Adjustment 4

AM OFFSET ADJUSTMENT

- Service Sheet 7

Description

The dc offset of the AM Offset Buffer is adjusted for 0.000 Vdc \pm 0.001 Vdc with the reference inputs to the Level DAC and AM% DAC grounded.

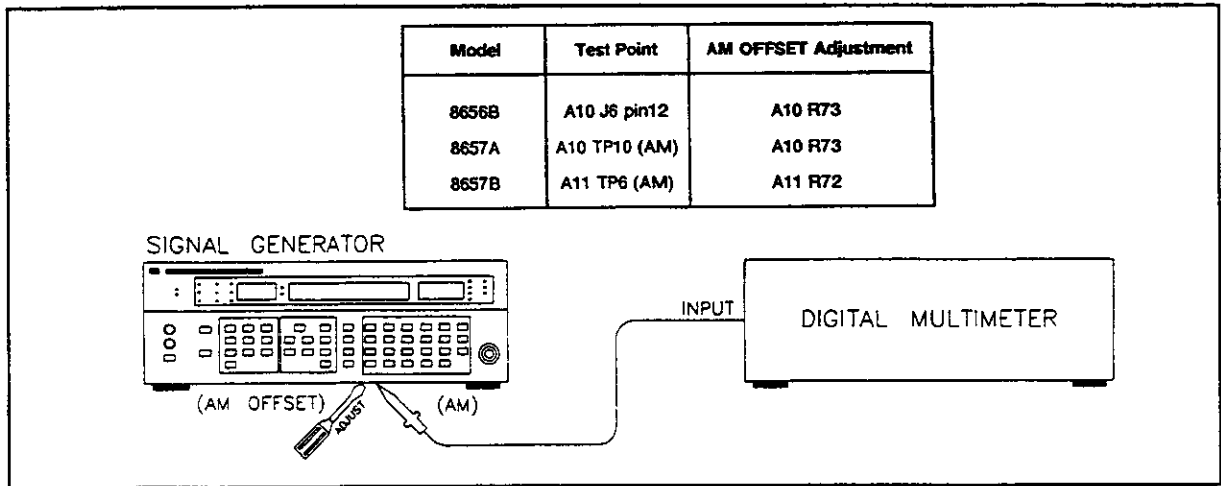

Figure 5-6. AM Offset Adjustment Setup

Equipment

Digital Multimeter HP 3466A

Procedure

1. Set the digital multimeter as follows:
 - Function Vdc
 - Range 200 mV
2. Reset the Signal Generator by pressing SHIFT and 0.
3. For the HP 8656B, short INPUT 1 (A10 TP1) and INPUT 2 (A10 TP6) to ground.
 For the HP 8657A, move A10 W3 and A10 W6 to their alternate positions.
 For the HP 8657B, move A11 W2 to its alternate position and short A11 TP5 to ground.

4. Referring to the table shown below, connect the digital multimeter to the relevant test point and adjust the AM OFFSET for $0.000 \text{ Vdc} \pm 0.001 \text{ Vdc}$.

Model	Test Point	AM OFFSET Adjustment
8656B	A10 J6 pin12	A10 R73
8657A	A10 TP10 (AM)	A10 R73
8657B	A11 TP6 (AM)	A11 R72

5. Remove all shorts and return all jumpers to their original positions.

Adjustment 5

50 MHZ REFERENCE OSCILLATOR LEVEL ADJUSTMENT

- Service Sheet 16

Description

The output power level of the 50 MHz Reference Oscillator is adjusted for a maximum level between +16 and +19 dBm at A3J8 using a measuring receiver.

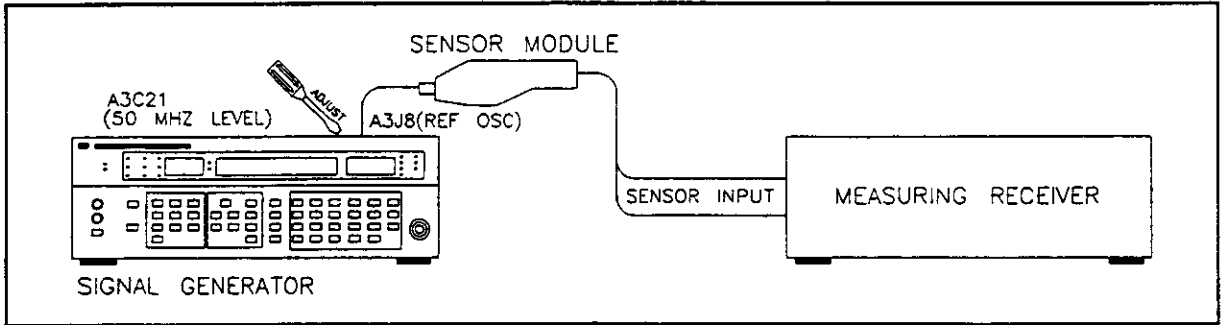

Figure 5–7. 50 MHz Reference Oscillator Level Adjustment Setup

Equipment

Measuring Receiver	HP 8902A
Sensor Module	HP 11722A
Cable BNC(m) to SMC(f)	HP 08662-60075
Adapter N(f) to BNC(m)	HP 1250-0077
Adapter BNC(f) to BNC(f)	HP 1250-0080

PROCEDURE

1. Set the measuring receiver with the sensor module precalibrated and connected as follows:

Measurement	RF POWER
Display	LOG
2. Disconnect coaxial cable W5 from A3J8 (50 MHz Reference Oscillator output). Connect the sensor module to A3J8 using the appropriate cable and adapters.
3. Press the **FREQ** key on the measuring receiver for calibration, then press the **RF POWER** key.
4. Adjust A3C21 (50 MHZ LEVEL ADJ) for a maximum RF Power reading from +16 dBm to +19 dBm. Do not adjust for a reading greater than +19 dBm.

NOTE

Do not remove the 50 MHz Section covers for this adjustment.

5. Disconnect the measuring receiver and reconnect W5 to A3J8.

Adjustment 6

50 MHz REFERENCE OSCILLATOR FREQUENCY ADJUSTMENT

- Service Sheet 16

Description

The internal 50 MHz Reference Oscillator frequency is adjusted to 50.0000 MHz \pm 100 Hz by adjusting the TIME BASE OUTPUT for 10.000 000 MHz \pm 20 Hz (50 MHz reference divided-by-10) using a frequency counter.

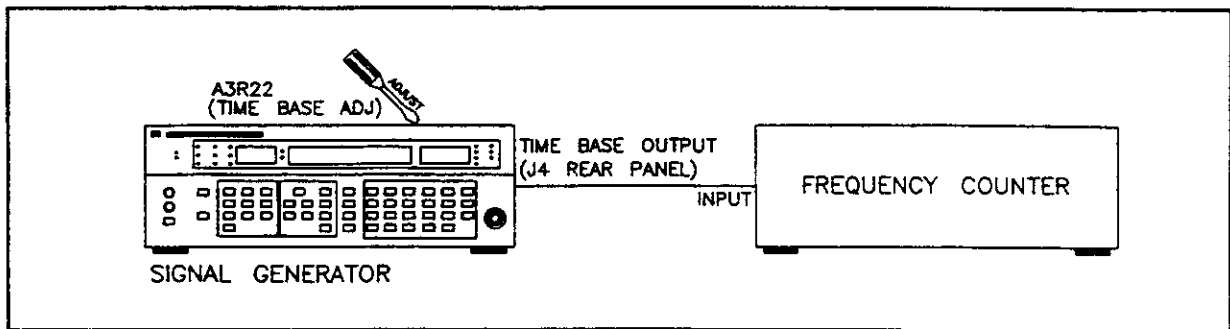

Figure 5-8. 50 MHz Reference Oscillator Frequency Adjustment Setup

Equipment

Frequency Counter	HP 5328B
Cable BNC(m).....	HP 10503A

NOTE

If the Signal Generator has Option 001 installed, disconnect the coaxial looping cable from the rear-panel TIME BASE INPUT connector.

Procedure

1. Connect the frequency counter to J4 using the BNC cable.
2. Adjust A3R22 (TIME BASE ADJ) for a frequency counter reading of 10.000 000 MHz \pm 20 Hz.

Adjustment 7

122 MHZ HARMONIC ADJUSTMENT

- Service Sheet 9

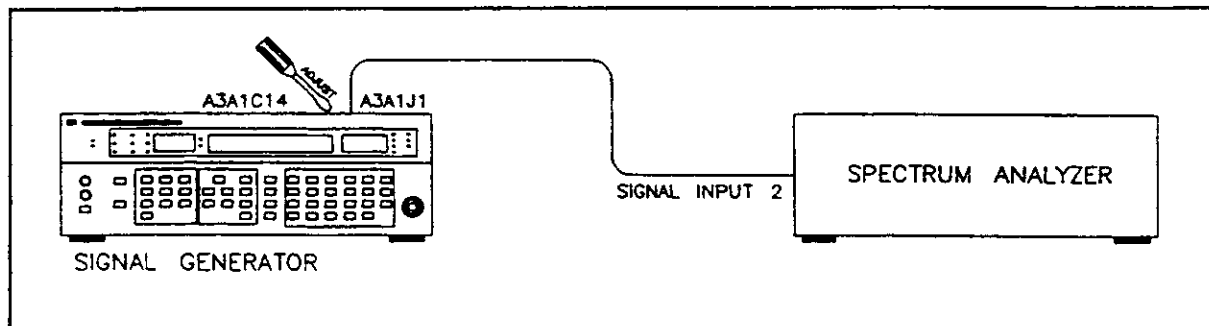

Figure 5-9. 122 MHz Harmonic Adjustment Setup

Description

The Signal Generator frequency is set to 539 MHz for a Low Frequency VCO Frequency of 61 MHz. The 122 MHz Harmonic is adjusted for a minimum.

Equipment

Spectrum Analyzer	HP 8562B
Cable BNC(m) to SMC(f)	HP 08662-60075
Adapter N(f) to BNC(m)	HP 1250-0077

Procedure

1. Set the spectrum analyzer as follows:

Center Frequency	95 MHz
Frequency Span	100 MHz
Reference Level	0 dBm
2. Set the Signal Generator as follows:

Frequency	539 MHz
Amplitude	Any
Modulation	Off
3. Connect the output of the A3A1 Assembly at A3A1J1 to the spectrum analyzer SIGNAL INPUT 2 using the appropriate cable and adapter (HP 1250-0077 and HP 08662-60075).
4. Adjust A3A1C14 for minimum 122 MHz harmonic.

Adjustment 8

400 MHZ BANDPASS FILTER ADJUSTMENT

- Service Sheet 3

Description

The 400 MHz Bandpass Filter is adjusted to peak the 800 MHz signal at RF Test Point A8TP3 using a measuring receiver.

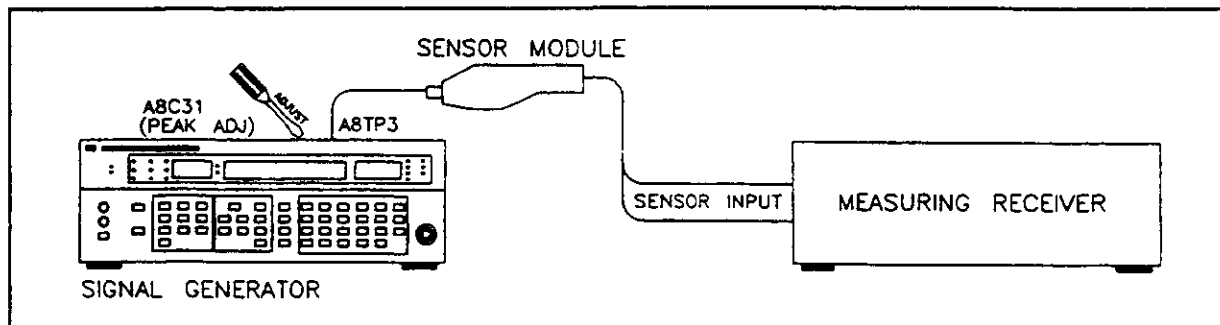

Figure 5-10. 400 MHz Bandpass Filter Adjustment Setup

Equipment

Measuring Receiver	HP 8902A
Sensor Module	HP 11722A
Adapter Probe	HP 1250-1598
Adapter N(f) to BNC(m)	HP 1250-0077
Adapter BNC(f) to BNC(f)	HP 1250-0080
Cable BNC(m) to SMC(f)	HP 08662-60075

Procedure:

1. Set the measuring receiver with the sensor module precalibrated and connected as follows:

Measurement	RF POWER
Display	LOG
2. Set the Signal Generator as follows:

Frequency	Any
Amplitude	-10 dBm
Modulation	Off
3. Zero the measuring receiver and wait for the zero LED to go out.
4. Connect the sensor module to the Signal Generator at RF Test Point A8TP3 using an adapter (HP part number 1250-1598).
5. Tune the measuring receiver to 800 MHz. For the 8657A, adjust A8C31 (PEAK ADJ) for a maximum RF power reading. For the 8656B and 8657B, adjust A8C31 (PEAK ADJ) and A8C61 for a maximum RF Power Reading.

Adjustment 9

690 TO 740 MHz IF COMPENSATION ADJUSTMENT AND ATTENUATOR PAD SELECT

- Service Sheets 1, 3, and 9

Description

A function generator is used to sweep the A3A1 Low Frequency VCO and provide a swept 690 to 740 MHz IF signal at A4TP3. The IF signal is adjusted for flatness within 3.5 dB. The average power level of the IF signal is then found and an attenuator pad is selected to provide an average IF input level of -9 dBm to mixer A4U1.

NOTE

The 690 to 740 MHz IF Compensation Adjustment and Attenuator Pad Select must be performed whenever the A3A1, A4, A8, or FL1 assemblies are replaced.

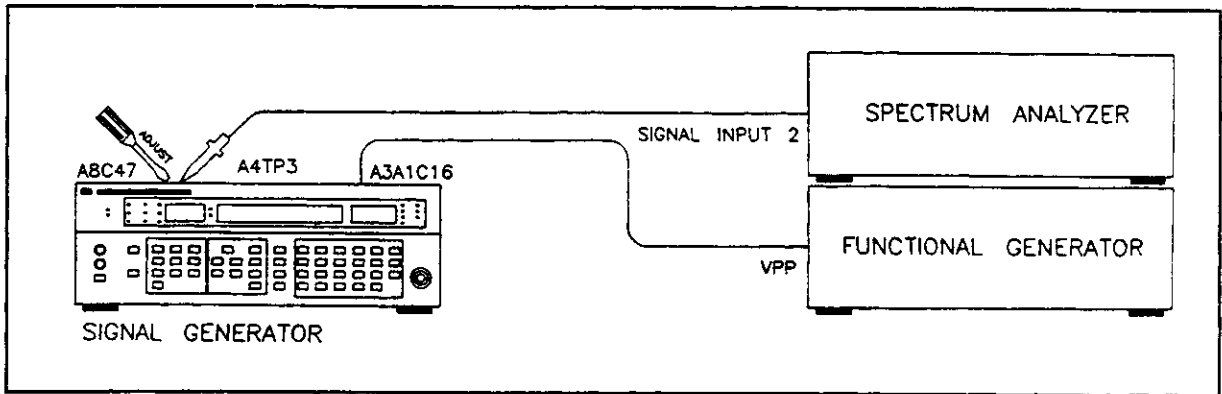

Figure 5-11. 690 to 740 MHz IF Compensation and Attenuator Pad Select

Equipment

Spectrum Analyzer	HP 8562A
Function Generator	HP 3312A
Cable BNC	HP 8120-1840
Test Leads alligator clips to BNC	HP 8120-1292
Adapter N(f) to BNC(m)	HP 1250-0077
Adapter Probe	HP 1250-1598
Cable BNC(m) to SMC(f)	HP 08662-60075

Procedure

1. Set the Signal Generator as follows:

Frequency 700 MHz
 Amplitude Any
 Modulation Off

2. Set the function generator as follows:

Frequency 3 kHz
 Function Triangle Wave
 Offset 0v
 Amplitude Range 10 vpeak
 Symmetry Cal
 Modulation Off

3. Preset the spectrum analyzer and set as follows:

RF Input Input 2
 Start Frequency 690 MHz
 Stop Frequency 740 MHz
 Reference Level -3 dBm
 Scale Log 1dB/Div
 Res BW Max
 Sweep 0.5 sec

4. Remove jumper A3W6 and connect the function generator to the Low Frequency VCO at feedthrough capacitor A3A1C16 using the appropriate cable and adapter.

NOTE

If A4R6 and A4R7 (P/O selectable attenuator pad) are already in the A4 assembly, they must be isolated from the circuit before proceeding with the next step. Replacement A4 assemblies are shipped from the factory without the attenuator pad installed.

5. Connect the spectrum analyzer SIGNAL INPUT 2 to the Signal Generator at A4TP3 using the appropriate cable and adapters (HP 1250-0780, HP 08662-60075, and HP 1250-1598).
6. If necessary, Adjust the amplitude and offset of the function generator until the swept IF signal displayed on the spectrum analyzer starts just at 690 MHz and stops just at 740 MHz.
7. Adjust A8C47 until the difference between the maximum and minimum IF levels is ≤ 3.5 dB.
8. Find the average IF level by dividing the difference between the maximum and minimum IF levels by 2, and then adding the result to the minimum IF level.
9. Refer to Table 5-1 (Factory Selected Components) and select the values of A4R6, R7, and R10 necessary for an average IF level of -9 dBm into mixer A4U1.

Adjustment 10a

HIGH FREQUENCY LOOP OFFSET ADJUSTMENT (HP 8656B ONLY)

- Service Sheet 2

Description

The tune voltage ramp from the Loop Amplifier is disconnected from the High Frequency Oscillator Assembly (A5) and then it is adjusted for a symmetrical ramp using an oscilloscope.

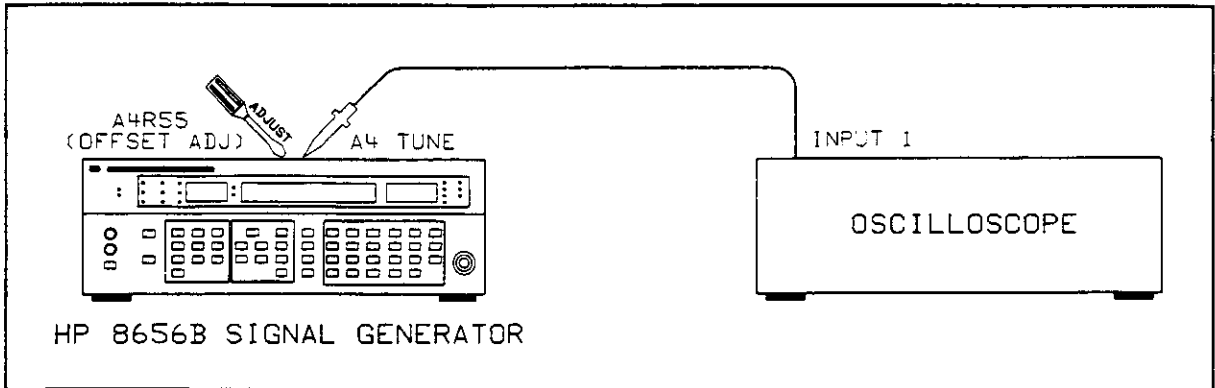

Figure 5-12. Notch Filters Adjustment Setup

Equipment

Oscilloscope	HP 54100A
Oscilloscope Probe	HP 54003A

Procedure

1. Set the oscilloscope as follows:

Vertical Gain	0.5 V/div
Sweep Speed	0.5 ms/div

2. Set the oscilloscope as follows:

Frequency	715 MHz
Amplitude	- 3 dBm
Modulation	OFF
Source	OFF
Frequency Increment Set	50 MHz

3. Disconnect the TUNE voltage wire (white-black-orange) from the High Frequency Oscillator Assembly (A5).
4. Connect the oscilloscope to TUNE voltage wire (white-black-orange).

5. Short Test Point A4TP13 to ground.
6. Adjust A4R55 (OFFSET ADJ) for the most symmetrical ramp as analyzed on the oscilloscope (equal rise and fall times) as shown in Figure 5-13.
7. Step the frequency up to 765 MHz and back to 715 MHz and ensure the ramp returns to its Symmetry.
8. Remove the oscilloscope and reconnect the TUNE voltage wire to the High Frequency Oscillator Assembly (A5).
9. Remove the short installed in step 5.

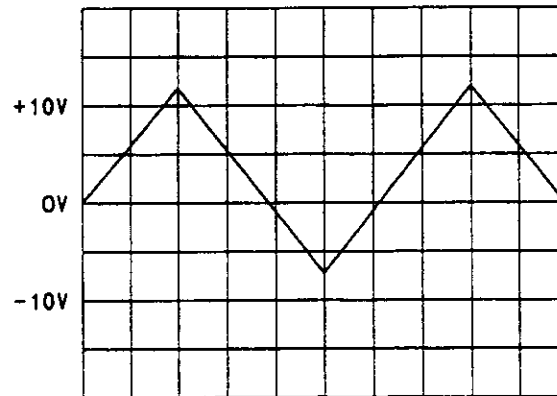

Figure 5-13. Tune Voltage Waveform

Adjustment 10b

715 MHZ SIDEBAND ADJUSTMENT (HP 8656B ONLY)

- Service Sheet 2

Description

The 715 MHz Sideband adjustment is made so that both inputs to the Sideband Comparator are equal with the HP 8656B frequency set to 715 MHz. The dc voltage between Test Points A4TP10 and A4TP11 (which are the inputs to the Sideband Comparator) is adjusted to $0 \text{ Vdc} \pm 0.007 \text{ Vdc}$ as the frequency is returned to 715 MHz from 765 MHz in a 50 MHz step.

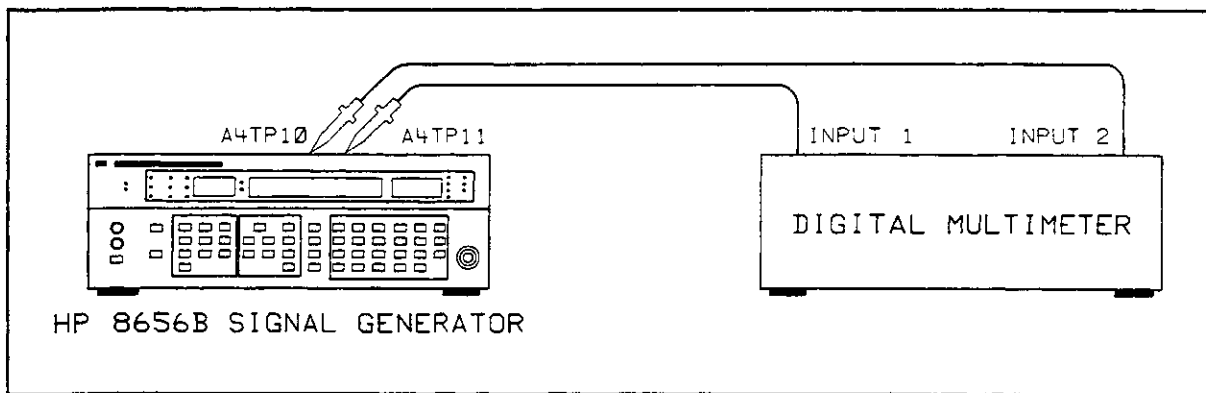

Figure 5-14. 715 MHz Sideband Adjustment Setup

Equipment

Digital Multimeter HP 3466A

Procedure

1. Set the digital multimeter as follows:

Function Vdc
 Range 200 mV

2. Set the HP 8656B as follows:

Frequency 715 MHz
 Frequency Increment 50 MHz
 Amplitude Any
 Modulation OFF

CAUTION

DO NOT CONNECT TP13 to TP16 when the test points are not grounded.

3. Connect the digital multimeter input between Test Points A4TP10 and A4TP11. Short Test Points A4TP13 and A4TP16 to ground.

4. Adjust A4R52 (715 MHz ADJ) for $0 \text{ Vdc} \pm 0.007 \text{ Vdc}$.
5. Increment the frequency to 765 MHz then back to 715 MHz.
6. Readjust A4R52 for $0 \text{ Vdc} \pm 0.007 \text{ Vdc}$ (if required).
7. Continue incrementing frequency and readjusting A4R52 until the offset is approximately $0 \text{ Vdc} \pm 0.007 \text{ Vdc}$.
8. Remove the two shorts installed in step 3.

Adjustment 10c

NOTCH FILTER ADJUSTMENTS (HP 8656B ONLY)

- Service Sheet 1

Description

Each one of the Notch Filters is adjusted using a signal source set to 50, 100, 150, 200, 250, and 300 MHz. The 50 to 250 MHz Notch Filters are de-selected one at a time to pass that frequency. With each filter de-selected and its output centered on a spectrum analyzer display, the Notch Filter is then re-selected and adjusted for a minimum signal output on the spectrum analyzer.

The two 300 MHz Notch Filters are in the circuit all of the time. A 300 MHz signal source is applied to the input of each filter and its output is connected to a spectrum analyzer. Each filter is then adjusted for a minimum signal output.

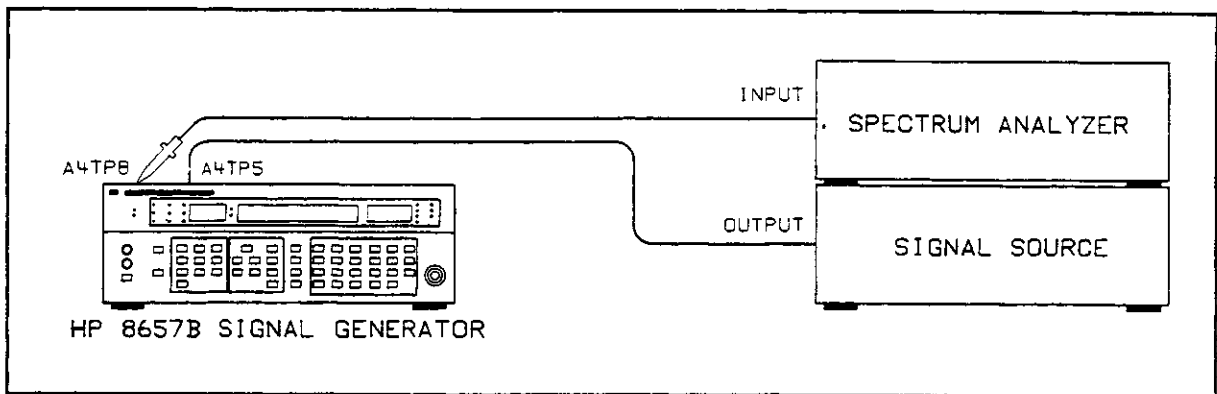

Figure 5-15. HP 8656B Notch Filters Adjustment Setup

Equipment

Signal Source	HP 8640B
Spectrum Analyzer)	HP 8568A or HP 8558B
Adaptor Probes (x2)	HP 1250-1598
Adaptors (x2) N(m) to BNC(f)	HP 1250-1780
Cables (x2) BNC(m) to SMC(f)	HP 08662-60075

Procedure

1. Set the signal source as follows:

Frequency	250 MHz
Counter Mode	Expand X10
Level	- 20 dBm
Modulation	OFF

2. Set the spectrum analyzer as follows:

Optimum Input	- 10 dBm
Reference Level	0 dBm
Frequency Span/Div	500 kHz
Resolution Bandwidth	30 kHz

3. Set the HP 8656B as follows:

Frequency.....	950 MHz
Frequency Increment	50 MHz
Amplitude.....	Any
Modulation.....	Off
4. Connect the signal source to the HP 8656B at RF Test Point A4TP5 using an adaptor (HP part number 1250-1598).
5. Connect the spectrum analyzer to the HP 8656B at RF Test Point A4TP8 using an adaptor (HP part number 1250-1598).
6. Adjust the spectrum analyzer to center the 250 MHz signal on the spectrum analyzer display.
7. Step the frequency down 50 MHz to 900 MHz.
8. Adjust A4C53 (250 MHz IF ADJ) for a minimum signal output on the spectrum analyzer display.
9. Tune the signal source to 200.000 MHz and center the 200 MHz signal on the spectrum analyzer display.
10. Step the frequency down 50 MHz to 850 MHz.
11. Adjust A4L36 (200 MHz IF ADJ) for a minimum signal output on the spectrum analyzer display.
12. Tune the signal source to 150.000 MHz and center the 150 MHz signal on the spectrum analyzer display.
13. Step the frequency down 50 MHz to 800 MHz.
14. Adjust A4L37 (150 MHz IF ADJ) for a minimum signal output on the spectrum analyzer display.
15. Remove X10 COUNTER MODE Expand. Tune the signal source to 100.000 MHz and center the 100 MHz signal on the spectrum analyzer display.
16. Step the frequency down 50 MHz to 750 MHz.
17. Adjust A4L38 (100 MHz IF ADJ) for a minimum signal output on the spectrum analyzer display.
18. Tune the signal source to 50.000 MHz and center the 50 MHz signal on the spectrum analyzer display.
19. Step the frequency up 50 MHz to 800 MHz.
20. Adjust A4L39 (50 MHz IF ADJ) for a minimum signal output on the spectrum analyzer display.
21. Connect the spectrum analyzer to the HP 8656B at RF Test Point A4TP6 using an adaptor (HP part number 1250-1598).
22. Set the signal source COUNTER MODE Expand to X10. Tune the signal source to 300.000 MHz and center the 300 MHz signal on the spectrum analyzer display.
23. Adjust A4L28 (300 MHz IN IF ADJ) for a minimum signal output on the spectrum analyzer display.
24. Connect the spectrum analyzer to the HP 8656B at RF Test Point A4TP8 using an adaptor (HP part number 1250-1598).
25. Connect the signal source to the HP 8656B at RF Test Point A4TP6 using an adaptor (HP part number 1250-1598) and bypass A4L28 (300 MHz IN IF ADJ) by placing a jumper across it.
26. Adjust A4C85 (300 MHz IF ADJ) for a minimum signal output on the spectrum analyzer display. Remove the jumper across A4L28.

Adjustment 10d

HP 8657A AND HP 8657B NOTCH FILTER ADJUSTMENTS

- Service Sheet 1

Description

Jumper A4W4 is moved to place the Signal Generator in a mode to continuously ramp the High Frequency Loop Amplifier and to sweep the High Frequency VCO. The Signal Generator frequency is set to 765 MHz to select the 50 MHz IF and to not select the 50 MHz Notch Filter. The detected beat notes are monitored with an oscilloscope and the 350, 300, 250, 200, 150, and 100 MHz Notch Filters are adjusted to minimize their associated beat notes. The Signal Generator's frequency is then set to 965 MHz to not select the 50 MHz IF. The 50 MHz Notch Filter is adjusted to minimize its beat note. The Signal Generator frequency is then set to 1015 MHz and adjusted to maximize the 300 MHz beat note.

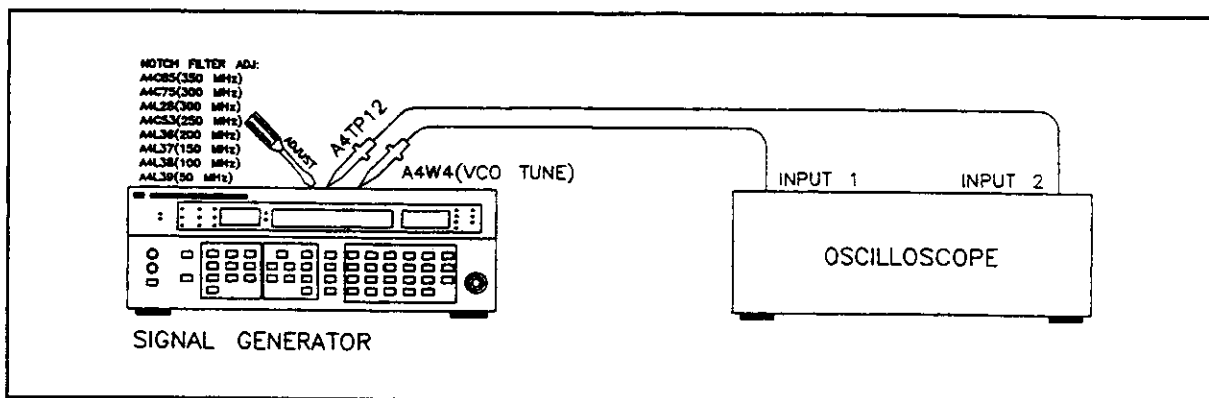

Figure 5-16. Notch Filters Adjustment Setup

Equipment

Oscilloscope	HP 54100A
Oscilloscope Probe (2 required)	HP 54003A

Procedure

1. On the Signal Generator move A4W2 to the LOCK CANCEL position. This places the Signal Generator in a continual ramp and sweep mode.
2. Connect the oscilloscope channel 1 probe to A4W4. Connect the channel 2 probe to A4TP12.
3. Set the Signal Generator as follows:

Frequency	765 MHz
Amplitude	-3 dBm
Modulation	Off

- Set the oscilloscope as follows: (settings are approximate, variations in voltages and times may require alternate settings)

CHANNEL 1

Volts/Div 500 mV
 Display Off
 Offset 105 mV

CHANNEL 2

Volts/Div 20 mV
 Display On
 Offset 32 mV

TIMEBASE

Sec/Div 1 mSec
 Delay 0 mS
 Delay Ref Center

TRIGGER

Source Chan 1
 Level 105 mV
 Slope Neg

DISPLAY

Split Screen Off
 Graticle Grid
 Mode Normal
 Persistence Adjust As Required

- The oscilloscope display for nonadjusted Notch Filters is shown in Figure 5-17.

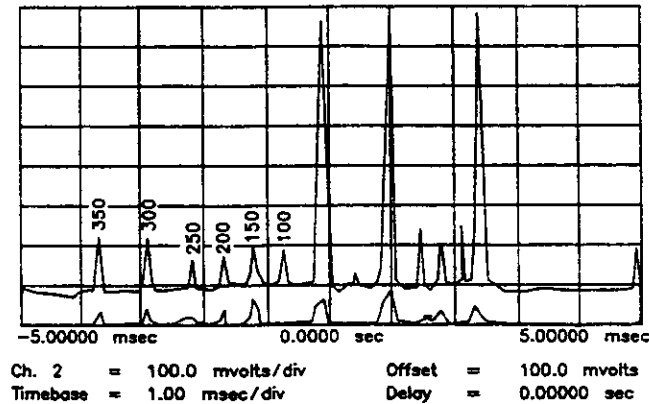

Figure 5-17. Frequency Response of Notch Filters, 765 MHz Setting.

6. Observe the oscilloscope Chan 2 display (beat notes) and refer to Figure 5-17. Adjust A4L38 (100 MHz Notch Filter) until you see the 100 MHz beat note change on the display, then adjust the beat note for minimum amplitude.
7. Adjust A4L37 (150 MHz Notch Filters) for minimum 150 MHz beat note.
8. Adjust A4L36 (200 MHz Notch Filter) for minimum 200 MHz beat note.
9. Adjust A4C53 (250 MHz Notch Filter) for minimum 250 MHz beat note.
10. Adjust A4L28 (300 MHz Notch Filter) for minimum 300 MHz beat note.
11. Adjust A4C75 (300 MHz Notch Filter) for minimum 300 MHz beat note.
12. Adjust A4C85 (350 MHz Notch Filter) for minimum 350 MHz beat note.
13. Set the Signal Generator frequency to 965 MHz and observe the oscilloscope Chan 2 display. The beat note levels should resemble those shown for channel 2 in Figure 5-18. (the 50 MHz beatnotes are shown with nonadjusted levels.) Adjust A4L39 (50 MHz Notch Filter) until the 50 MHz beat notes are at their minimum amplitude. Adjust A4C75 to maximize the 250 MHz signal while keeping the 300 MHz signal at minimum.

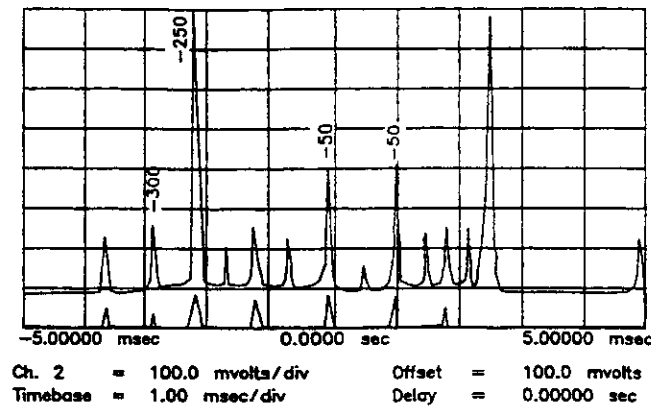

Figure 5-18. Frequency Response of Notch Filters, 965 MHz Setting.

14. Set the Signal Generator to a frequency of 1015 MHz and observe the oscilloscope Chan 2 display. The beat note levels should resemble those shown for channel 2 in Figure 5-19. Adjust A4C85 to maximize the 300 MHz beat note while keeping the 350 MHz beat note at a minimum.

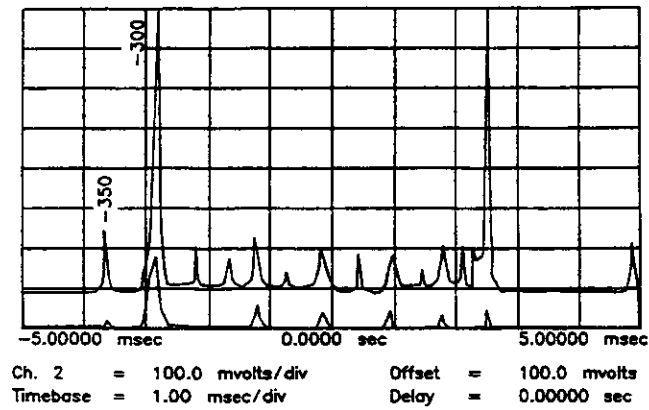

Figure 5--19. Frequency Response of Notch Filters, 1015 MHz Setting.

15. When notch filter adjustments are complete, return A4W4 to the lock position.

Adjustment 11

400 MHZ NOTCH FILTER ADJUSTMENT (HP 8657A AND HP 8657B ONLY)

- Service Sheet 1

Description

The 400 MHz Notch Filter is in the circuit all of the time and is adjusted for 1 MHz offset spurious signals from the selected frequency of 551 MHz.

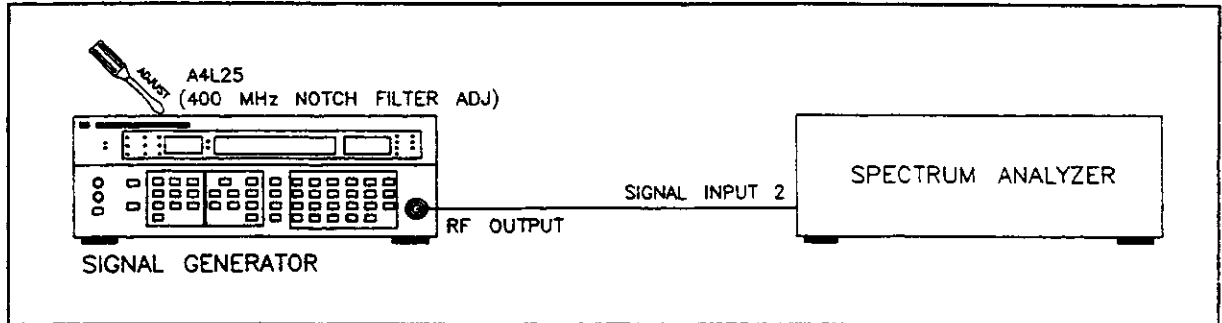

Figure 5-20. 400 MHz Notch Filter Adjustment Setup.

Equipment

Spectrum Analyzer	HP 8562B
Cable (N(m) 2 183 cm)	HP 11500A

Procedure

1. Set the spectrum analyzer as follows:

Center Frequency	550 MHz
Frequency Span	10 MHz
Reference Level	0 dBm
Res BW	30 kHz
2. Set the Signal Generator as follows:

Frequency	547 MHz
Amplitude	0 dBm
Frequency Increment	1 MHz
Modulation	Off
3. Connect the Signal Generator RF OUTPUT to spectrum analyzer SIGNAL INPUT 2.
4. Step the Signal Generator frequency in 1 MHz steps from 547 to 553 MHz. Adjust A4L25 for minimum spurious signals in the frequency range. Ensure that all spurious signals are <60 dB.

Adjustment 12a

HP 8656B LEVEL AND ALC LOOP DETECTOR ADJUSTMENT

- Service Sheet 5

DESCRIPTION

The reference level to the Level Digital to Analog Converter is adjusted to $+7.0 \text{ dBm} \pm 0.02 \text{ dB}$. Then the detector bias reference level to the ALC amplifier is adjusted to $-3.0 \text{ dBm} \pm 0.02 \text{ dB}$.

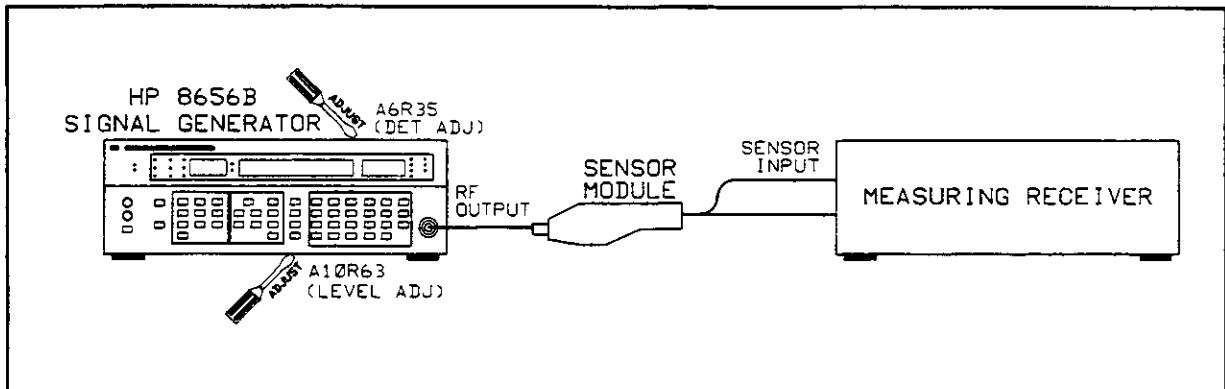

Figure 5-21. Level and ALC Loop Detector Adjustment Setup

EQUIPMENT

Measuring Receiver	HP 8902A
Sensor Module	HP 11722A

PROCEDURE

1. Set the measuring receiver with the sensor module precalibrated and connected as follows:

Measurement	RF POWER
Display	LOG
2. Set the HP 8656B as follows:

Frequency	820 MHz
Amplitude	+7 dBm
Amplitude Increment	10 dB
Modulation	Off

NOTE

Before making the adjustment, the instrument must be warmed up for a minimum of 1/2 hour.

3. Zero the sensor module and connect it to the RF OUTPUT connector of the HP 8656B.
4. Tune the measuring receiver to the HP8656B frequency by pressing the **FREQ** key. Press the **RF POWER** key and adjust A10R63 (LEVEL ADJ) for a reading of $+7.0 \text{ dBm} \pm 0.2 \text{ dB}$.

5. Press the **RATIO** key on the measuring receiver to set a reference level of 0 dBm.
6. Set the HP 8656B amplitude down to -3 dBm.
7. Adjust A6R35 (DET ADJ) for an RF Power level of $-9.95 \text{ dB} \pm 0.1 \text{ dB}$.
8. Repeat steps 4,5,6 and 7 until both readings are within the required tolerance.

Adjustment 12b

HP 8656B HETERODYNE BAND 800 MHZ BANDPASS FILTER ADJUSTMENT

NOTE

This adjustment must be done before the "HETERODYNE BAND ACCURACY AND FLATNESS ADJUSTMENTS."

- Service Sheet 5

DESCRIPTION

The 800 MHz Bandpass filter (input to the Heterodyne mixer) is adjusted for maximum HP 8656B output amplitude and minimum spurs. Output amplitude and 800 MHz are adjusted for a maximum with the frequency set to 100 MHz. The frequency is then set to 99 MHz and 101 MHz and readjusted as required for minimum spurs 1 MHz and 2 MHz offset from 99 MHz and 101 MHz. The amplitude of the output must stay within 1 dB of the peak, and the amplitude of the 800 MHz must stay within 2 dB of the peak.

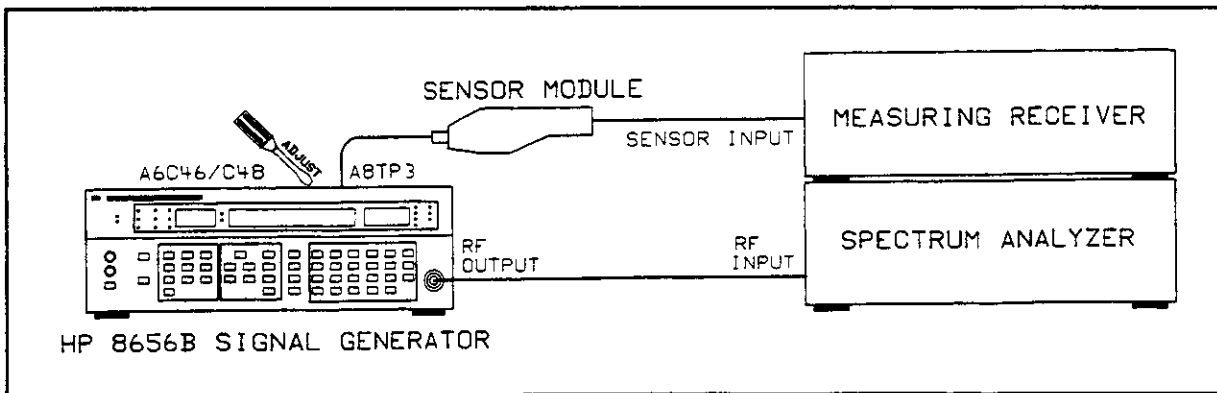

Figure 5-22. Heterodyne Band 800 MHz Bandpass Filter Adjustment Setup

EQUIPMENT

Spectrum Analyzer	HP 8568A or 8558B
Measuring Receiver	HP 8902A
Cable BNC(m) to SMC(f)	HP 08662-60075
Adapter N(f) to BNC(m)	HP 1250-0077
Adapter BNC(f) to BNC(f)	HP 1250-0080
Adapter Probe	HP 1250-1598

PROCEDURE

1. Set the spectrum analyzer as follows:

Center Frequency 100 MHz
 Frequency Span 10 MHz
 Reference Level 0 dB
 Scale 1 dB/Div
 Resolution Bandwidth 30 kHz

2. Set the HP 8656B as follows:

Frequency 100 MHz
 Frequency Increment 1 MHz
 Amplitude -3 dBm
 Modulation Off

3. Set the measuring receiver with the sensor module precalibrated and connected as follows:

Measurement RF POWER
 Display LOG

4. Zero the measuring receiver and wait for the zero LED to go out. Connect the measuring receiver to A8TP3.
5. Adjust A6C46 and A6C48 for maximum signal level on the spectrum analyzer's display and on the measuring receiver.
6. Set the spectrum Analyzer to 10 dB/Div.
7. Increment the HP 8656B frequency down to 99 MHz. Adjust A6C46 and A6C48 as required so that spurs 1 MHz and 2 MHz offset from 99 MHz are -65 dBc. The amplitude of the HP 8656B's output amplitude must be within 1 dB of the peak in step 5.
8. Increment the HP 8656B frequency up to 101 MHz. Adjust A6C46 and A6C48 as required so that spurs 1 MHz and 2 MHz offset from 101 MHz are -65 dBc.
9. Decrement the HP 8656B frequency down to 100 MHz. The amplitude of the HP 8656B's output amplitude must be within 1 dB of the peak in step 5 and the 800 MHz at A8TP3 must be within 2 dB of the peak in step 5.
10. If the 800 MHz at A8TP3 has changed by more than 2 dB, adjust A6C46 to reset the power level and re-check for spurs.
11. If the amplitude of the HP 8656B's output has changed more than 1 dB, perform the HETERODYNE BAND ACCURACY AND FLATNESS ADJUSTMENT (Adjustment 12c).

Adjustment 12c

HP 8656B HETERODYNE BAND ACCURACY AND FLATNESS ADJUSTMENTS

- Service Sheet 5

DESCRIPTION

The accuracy and flatness of the Heterodyne band are adjusted for an equal power difference from 0 dBm at 10 MHz and 123 MHz and power variation not greater than ± 0.5 dB for frequencies between 3 MHz and 123 MHz.

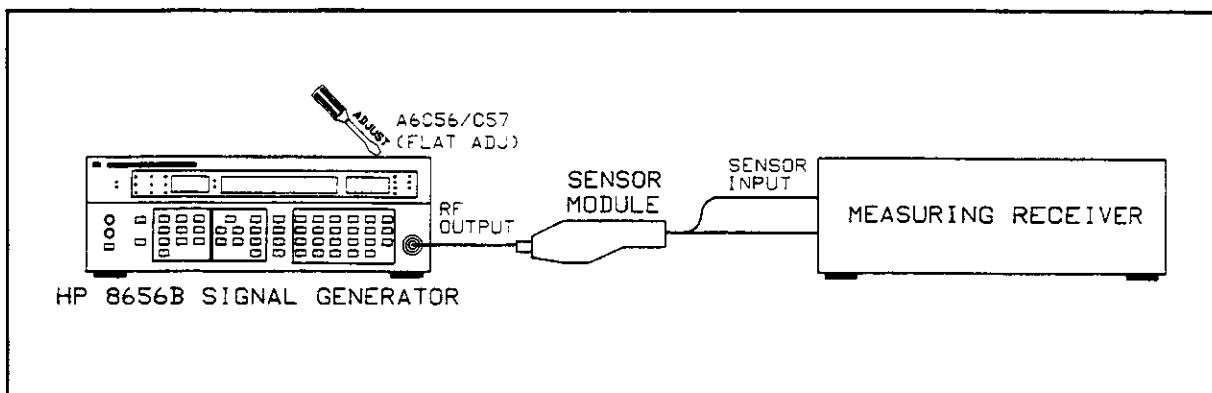

Figure 5-23. Heterodyne Band Accuracy and Flatness Setup

EQUIPMENT

Measuring Receiver	HP 8902A
Sensor Module	HP 11722A

PROCEDURE

1. Set the measuring receiver with the sensor module precalibrated and connected as follows:

Measurement	RF POWER
Display	LOG
2. Set the HP 8656B as follows:

Frequency	10 MHz
Frequency Increment	5 MHz
Amplitude	+0 dBm
Modulation	Off
3. Zero the sensor module and connect it to the RF OUTPUT connector on the HP 8656B.
4. Tune the measuring receiver to the HP 8656B by pressing the FREQ key. Press the RF POWER key and adjust A6C56 (ACC ADJ) for a 0 dBm ± 0.5 dB reading on the measuring receiver.

5. Change the frequency to 123 MHz and tune the measuring receiver to the HP 8656B as shown in step 4.
6. Adjust A6C57 (FLAT ADJ) for a $0 \text{ dBm} \pm 0.5 \text{ dB}$ reading on the measuring receiver.

NOTE

If A6C57 does not have the range to adjust the amplitude at 123 MHz to $0 \text{ dBm} \pm 0.5 \text{ dB}$, repeat step 4 adjusting A6C56 to increase or decrease the amplitude until both adjustments are within the specified limits. A6C56 is used to shift the amplitude level of the Heterodyne band.

7. Step the frequency in 5 MHz increments between 3 MHz and 123 MHz, recalibrating the measuring receiver as mentioned in step 4 for each change in frequency. The amplitude variation from maximum to minimum should not exceed 1 dB. If the amplitude variation is greater than 1 dB, repeat steps 4,5 and 6 to compensate the flatness so that the amplitude remains within $0.0 \text{ dBm} \pm 0.5 \text{ dB}$.

Adjustment 12d

HP 8657A/HP 8657B LEVEL AND ALC LOOP DETECTOR ADJUSTMENTS

- Service Sheets 4 and 7

DESCRIPTION

First, the reference level to the Level Digital to Analog Converter (DAC) is adjusted for a set RF Output level depending on the Signal Generator being used. Then the detector bias reference level to the ALC Amplifier is adjusted, followed by adjusting the Heterodyne pin diodes biasing.

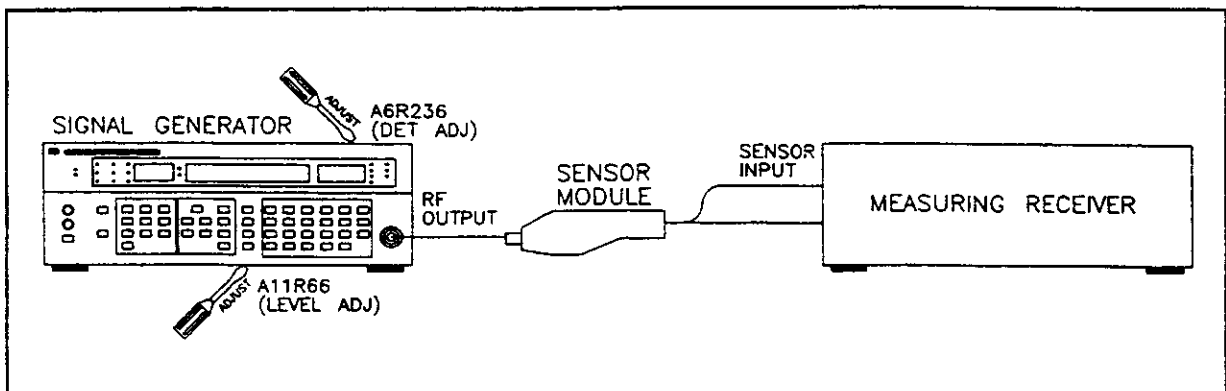

Figure 5-24. Level and ALC Loop Detector Adjustment Setup

EQUIPMENT

Measuring Receiver	HP 8902A
Sensor Module	HP 11722A
Digital Multimeter	HP 3466A

PROCEDURE

1. Set the measuring receiver with the sensor module precalibrated and connected as follows:

Measurement	RF POWER
Display	LOG
2. Set the Signal Generator as follows:

Frequency	820 MHz
Amplitude (HP 8657A)	+7 dBm
Amplitude (HP 8657B)	+6.5 dBm (+3.5 dBm for opt.003)
Modulation	Off
Amplitude Increment (HP 8657A)	10 dB
Amplitude Increment (HP 8657B)	5 dB

NOTE

Before making the adjustment, the Signal Generator must be warmed up for a minimum of 1/2 hour.

3. Zero the sensor module and connect it to the RF OUTPUT connector on the Signal Generator.
4. Tune the measuring receiver to the Signal Generator frequency by pressing the **FREQ** key. Press the **RF Power** key and adjust the **(LEVEL ADJ)** resistor for the values shown in the table below.

Model	(LEVEL ADJ)	Adjust for:
8657A	A10 R63	+7.0dBm \pm 0.2dB
8657B	A11 R66	+6.5dBm \pm 0.2dB
8657B opt.003	A11 R66	+3.5dBm \pm 0.2dB

5. Press the **RATIO** key on the measuring receiver to set a reference level of 0 dB.
6. Decrement the Signal Generator amplitude. The Signal Generator will now display:

HP 8657A -3.0 dBm
 HP 8657B +1.5 dBm
 HP 8657B, opt.003 -1.5 dBm

Referring to the table below, adjust the relevant resistor for the value shown.

Model	(LEVEL ADJ)	Adjust for:
8657A	A10 R236	-9.95dBm \pm 0.1dB
8657B all opts.	A11 R236	-4.95dBm \pm 0.1dB

7. Repeat steps 4, 6, and 7 until both readings are within the required tolerance.

NOTE

The following test can only be performed on the HP 8657B.

8. Set the HP 8657B to 65 MHz.
9. Connect the digital multimeter to pin 6 of A6 U302.
10. Adjust A6 R355 for +3.0 Vdc \pm 0.1 V.

Adjustment 13

AM% AND ALC LOOP AM ADJUSTMENTS

- Service Sheets 4 and 7

Description

The reference level to the AM% Digital to Analog Converter (DAC) is adjusted for an average amplitude modulation of 21.21%. The AM reference to the ALC Amplifier is adjusted for minimum distortion of the modulation.

NOTE

The AM Offset, and Level and ALC Loop Adjustments must be performed before performing these adjustments. Refer to Adjustment 4 and Adjustment 12.

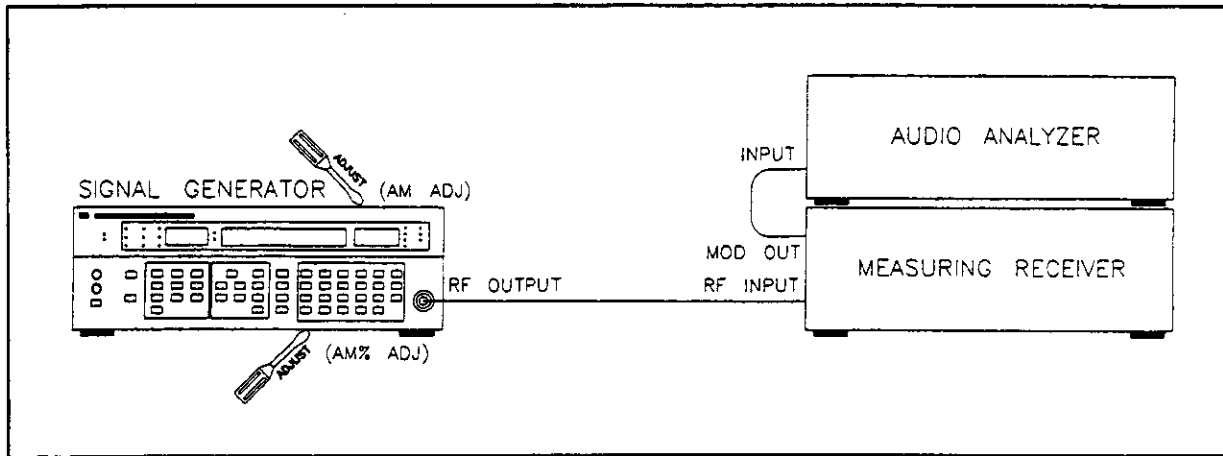

Figure 5-25. AM% and ALC Loop AM Adjustments Setup

Equipment

Measuring Receiver	HP 8902A
Audio Analyzer	HP 8903B

Procedure

1. Set the measuring receiver as follows:

Measurement	AM
Detector	AVG
HP Filter	50 Hz
LP Filter	15 kHz

2. Set the Signal Generator as follows:

- Frequency..... 200 MHz
- Amplitude..... +4 dBm
- Amplitude (HP 8567B Pulse Modulation installed) +1 dBm
- Modulation.....AM 30%
- Source 1 kHz (Int.)

3. Connect the measuring receiver to the RF OUTPUT connector on the Signal Generator and connect the distortion analyzer as shown in Figure 5-25.

4. Adjust the relevant AM% ADJ as shown in the following table for a reading of 21.21% on the measuring receiver.

Model	Adjustment
HP 8656B	A10R66
HP 8657A	A10R66
HP 8657B	A11R62

NOTE

Do not remove any of the internal RF covers for this adjustment.

5. Set the Signal Generator as follows:

- Frequency..... 200 MHz
- Amplitude (HP 8656B and HP 8657A) -3 dBm
- Amplitude (HP 8657B) +1.5 dBm
- Amplitude (HP 8657B with Pulse Modulation installed)..... -1.5 dBm
- Modulation.....AM 90%

6. Set the measuring receiver as follows:

- Detector $\frac{PK^+ + PK^-}{2}$

7. Adjust the relevant AM ADJ as shown in the following table for a minimum reading on the measuring receiver as close to 90% as possible, while keeping the 1 kHz audio distortion less than 4%. Select the Audio Distortion measurement on the measuring receiver for a 1 kHz audio signal to measure the distortion.

Model	Adjustment
HP 8656B	A6R30
HP 8657A	A6R248
HP 8657B	A6R248

Adjustment 14

HP 8657B ONLY - AM% IN THE DOUBLE BAND ADJUSTMENTS

- Service Sheets 4 and 7

Description

The AM% level to the doubler is adjusted for a Peak - setting of 30%.

NOTE

This test can be performed on the HP 8657B only.

The AM% and ALC Loop AM Adjustments must be performed before performing these adjustments. Refer to Adjustment 13.

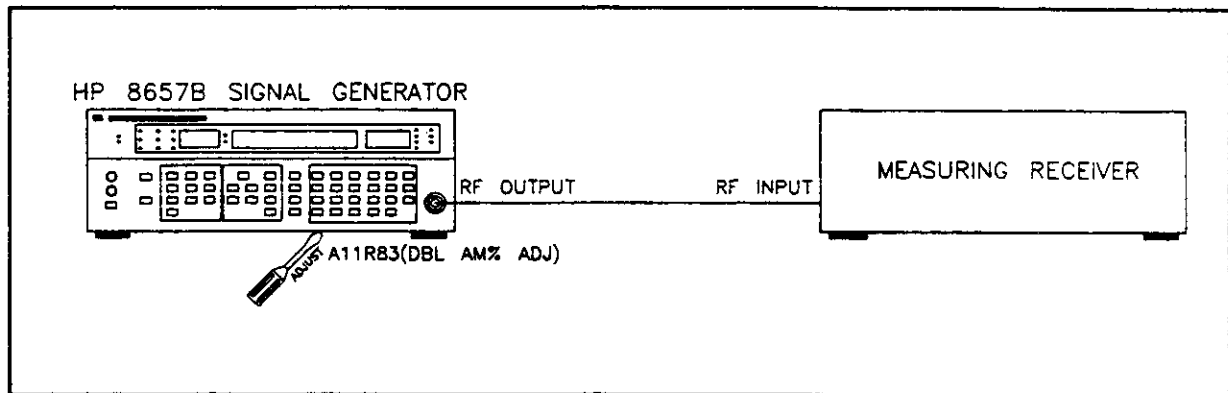

Figure 5-26. AM% and ALC Loop AM Adjustments Setup

Equipment

Measuring Receiver HP 8902A

Procedure

1. Set the measuring receiver as follows:

Measurement	AM
Detector	$\frac{PK^+ + PK^-}{2}$
HP Filter	50 Hz
LP Filter	15 kHz

2. Set the HP 8657B as follows:

Frequency	1200 MHz
Amplitude	+4 dBm
Modulation	AM 30%
Source	1 kHz (Int.)

3. Connect the measuring receiver to the RF OUTPUT connector on the HP 8657B.
4. Adjust A11R83 (DBL AM% ADJ) for a reading of 30% on the measuring receiver.

NOTE

Do not remove any of the internal RF covers for this adjustment.

Adjustment 15

FM CALIBRATION PRETUNE ADJUSTMENT

- Service Sheet 14

Description

The Low Frequency Loop is locked during this adjustment. The output of the integrator is adjusted so that the bottom of the integrator waveform is -6.0 volts. This adjustment assures that the VCO's tune voltage will have sufficient range.

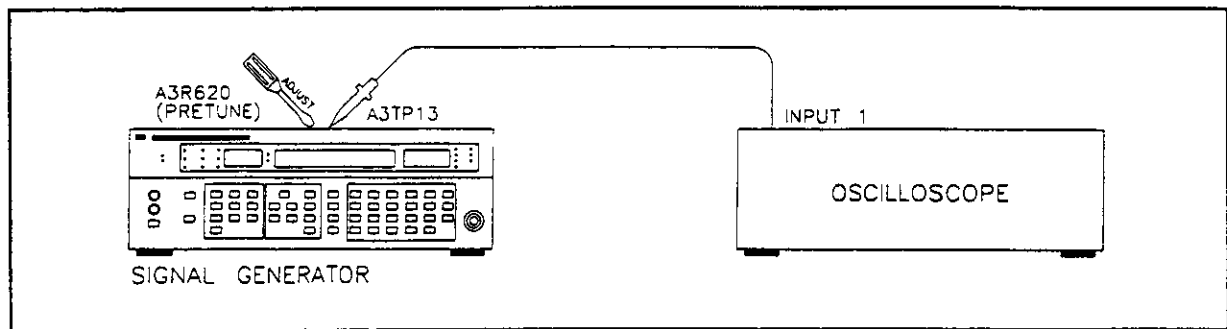

Figure 5-27. FM Calibration Pretune Adjustment Setup

Equipment

Oscilloscope	HP 54100A/54110A
Oscilloscope Probe Pod (Chan 1)	HP 54003A

Procedure

1. Set the Signal Generator as follows:

Frequency	117 MHz
Amplitude	Any
Modulation	Off

2. Connect the oscilloscope probe to A3TP13, Integrator Output.

- Set the oscilloscope as follows: (with AUTO-SCALE, the oscilloscope should preset to approximately the following conditions)

CHAN

Channel 1
 V/div 1V
 Offset -6V
 Probe 10:1
 Coupling dc, 1MΩ

TIME

Sec/div 2 μs
 Delay 0 s
 Reference Center

TRIG

Mode - Edge
 Source Chan 1
 Slope Neg

DISPLAY

Mode Averaged
 Graticule Type Grid
 Averages 4

- Adjust A3R620 (PRETUNE) for a voltage of -6.0 volts ±0.5 volts at the bottom of the integrator waveform (the oscilloscope Delta V and marker functions can be used to set a reference line at -6V as a calibration aid).

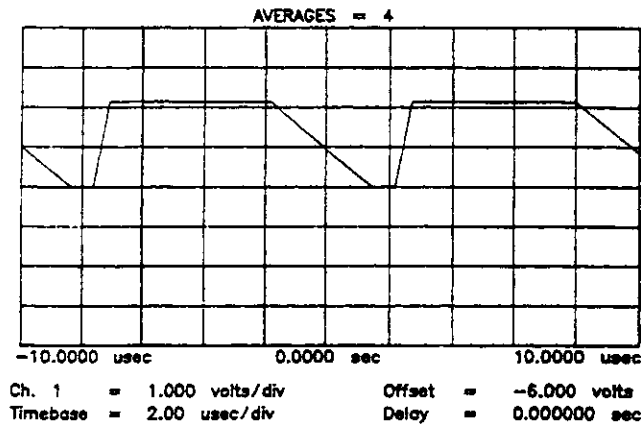

Figure 5-28. Sample of Oscilloscope Display

Adjustment 16

API 1, 2, 3 AND 4 ADJUSTMENTS

- Service Sheet 12

Description

The API, Analog Phase Interpolation, spurious signals are adjusted for -60 dBc using a spectrum analyzer.

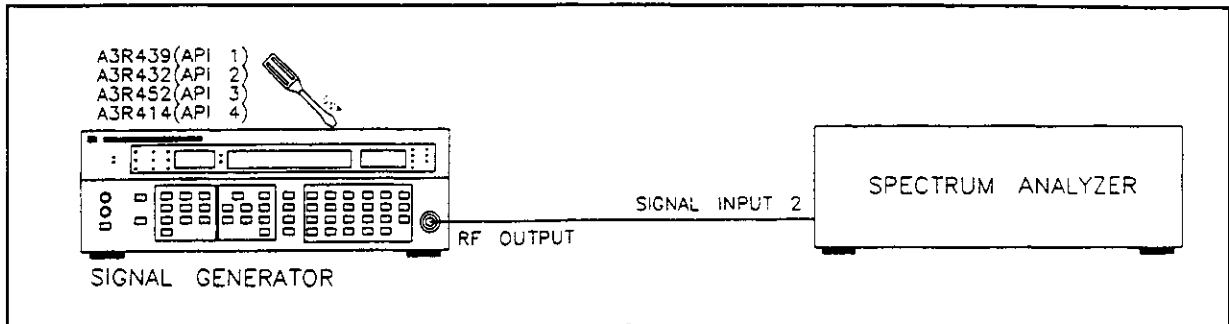

Figure 5-29. API 1, 2, 3 and 4 Adjustment Setup

Equipment

Spectrum Analyzer HP 8562B
 Cable (50 ohm coax, UG-21D/U type N (m) connectors) HP 11500A

NOTE

The A3 Assembly must be fastened to RFI cover (MP12) with hex nuts before making API adjustments.

Procedure

1. Set the spectrum analyzer as follows:

Center Frequency	65 MHz
Frequency Span	10 kHz
Reference Level	0 dBm
2. Set the Signal Generator as follows:

Frequency	65 MHz
Amplitude	0 dBm
Modulation	Off
3. Connect the RF OUTPUT of the Signal Generator to the spectrum analyzer as shown in Figure 5-29.
4. Change the Signal Generator frequency to 65.002 MHz.
5. Adjust A3R439 (API 1) so the spurious signals 1 and 2 kHz from the carrier are at minimum (less than -60 dBc).

6. Change the Signal Generator frequency to 65.0002 MHz.
7. Adjust A3R432 (API 2) so the spurious signals 1 and 2 kHz from the carrier are at minimum (less than -60 dBc).
8. Change the Signal Generator frequency to 65.00002 MHz.
9. Adjust A3R452 (API 3) so the spurious signals 1 and 2 kHz from the carrier are at minimum (less than -60 dBc).
10. Change the Signal Generator frequency to 65.00001 MHz.
11. Set the spectrum analyzer frequency span to 25 kHz.
12. Adjust A3R414 (API 4) so spurious signals 5 and 10 kHz from the carrier are at minimum (less than -60 dBc).

Adjustment 17

PEDESTAL ADJUSTMENT

- Service Sheet 13

Description

The Sample and Hold circuit current is adjusted for a spurious signal less than -60 dBc using a spectrum analyzer.

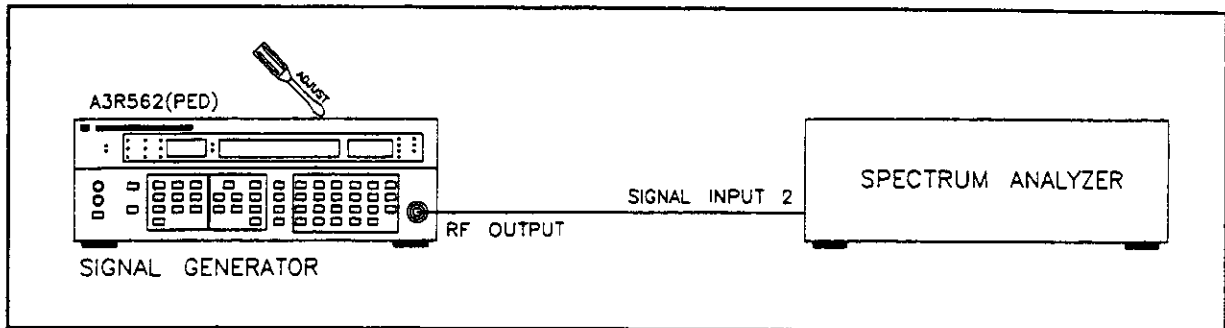

Figure 5-30. Pedestal Adjustment Setup

Equipment

Spectrum Analyzer	HP 8562B
Cable (50 ohm coax, UG-21D/U type N (m) connectors)	HP 11500A

Procedure

1. Set the spectrum analyzer as follows:

Center Frequency	65.1 MHz
Frequency Span	10 kHz
Reference Level	-30 dBm
2. Set the Signal Generator as follows:

Frequency	65 MHz
Amplitude	Any
Modulation	Off
3. Connect the RF OUTPUT of the Signal Generator to the spectrum analyzer as shown in Figure 5-30.
4. Adjust A3R562 (PED) so the spurious signal 100 kHz from the carrier is at minimum (less than -60 dBc). Frequency Span settings on the spectrum analyzer can be reduced to as low as 200 Hz and Center Frequencies changed to facilitate viewing the spurious signal.

Adjustment 18

INTEGRATOR INPUT OFFSET ADJUSTMENT

- Service Sheet 13

Description

The voltage at the input to the integrator is adjusted such that the voltage at a VCO frequency of 60 MHz is always lower than a VCO frequency of 110 MHz at A3 W1.

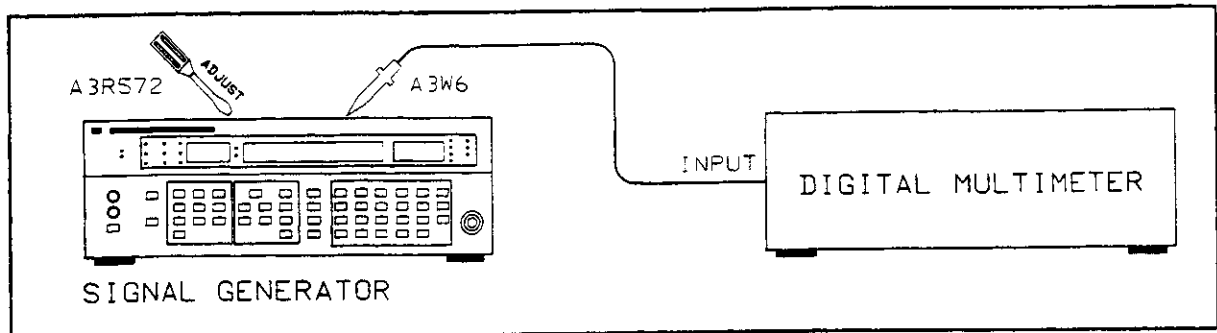

Figure 5-31. Integrator Input Offset Adjustment Set-up

Equipment

Digital Multimeter HP 3466A

Procedure

1. Set the Signal Generator to 715 MHz and then step up 25 MHz to 740MHz (this ensures that the Low Frequency VCO is set to 60 MHz).
2. Connect the digital multimeter between A3 W1 and ground and adjust A3 R572 for $0\text{ V} \pm 10\text{mV}$.
3. Set the Signal Generator to 715 MHz and then step down 25 MHz to 690 MHz (this ensures that the Low Frequency VCO is set to 110 MHz).
4. Measure the voltage on A3 W1 and adjust A3 R572 until this voltage is halved. Call this voltage (V2).
5. Step from 690 MHz to 740 MHz and ensure that the voltage measured on A3 W1 is always less than (V2).

Adjustment 19

DC FM SPURIOUS SIGNAL ADJUSTMENT

- Service Sheet 15

Description

The DC FM spurious signals are adjusted using a spectrum analyzer and a dc power supply.

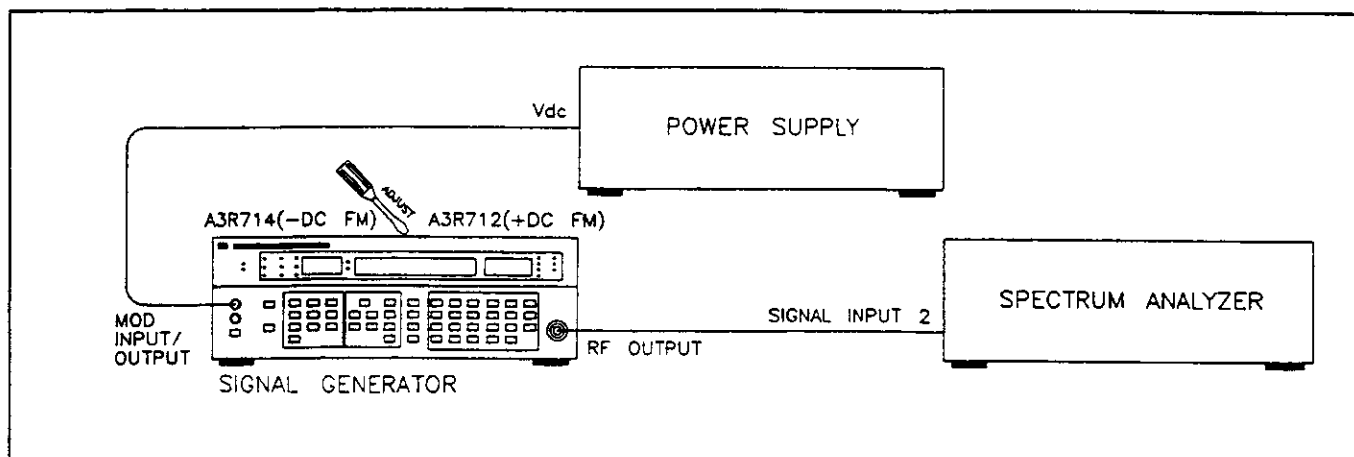

Figure 5-32. DC FM Spurious Signal Adjustment Setup

Equipment

Spectrum Analyzer	HP 8562B
Power Supply	HP 6214B
Cable (50 ohm coax, UG-21D/U type N(m) connectors)	HP 11500A
Cable (112 cm 50 ohm coax, UG-88C/U BNC to dual banana plug)	HP 11001-60001

Procedure

1. Set the spectrum analyzer as follows:

Center Frequency	65 MHz
Frequency Span	10 kHz
Reference Level	0 dBm

2. Set the power supply as follows:

Meter	Volts
Voltage	1 Vdc

3. Set the Signal Generator as follows:

Frequency	65 MHz
Amplitude	0 dBm
Modulation	DC FM, 3 kHz

4. Connect the Signal Generator RF OUTPUT to the spectrum analyzer SIGNAL INPUT 2 and the MOD INPUT/OUTPUT to the power supply +1 Vdc as shown in Figure 5-32.

NOTE

The LO EXT Modulation annunciator remains on regardless of the dc input level applied to the MOD INPUT/OUTPUT connector.

5. Adjust A3R712 (+DC FM) so spurious signals are -50 dBc.
6. Connect -1 Vdc to the MOD INPUT/OUTPUT.
7. Adjust A3R714 ($-$ DC FM) so spurious signals are -50 dBc.

Adjustment 20

VOLTAGE OFFSET ADJUSTMENT

- Service Sheet 7

Description

The DC offset of the FM Deviation Summing Amplifier is adjusted for 0.000 Vdc \pm 0.001 Vdc.

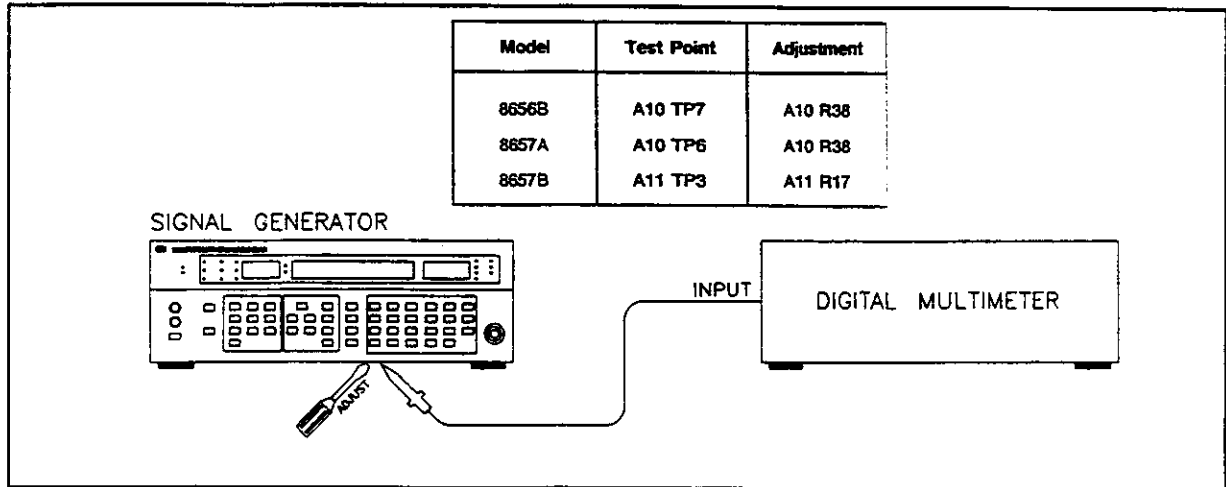

Figure 5-33. DC FM Offset Adjustment Setup

Equipment

Digital Multimeter HP 3466A

NOTE

The HP 8657B A11 Assembly must be fastened in the instrument before making the Voltage Offset Adjustment.

Procedure

1. Set the digital multimeter as follows:
 - Function Vdc
 - Range 200 mV
2. Set the Signal Generator as follows:
 - Frequency 65 MHz
 - Amplitude Any
 - Modulation DC FM, 99 kHz
3. Remove any signal connected to the Signal Generator MOD INPUT/OUTPUT connector.

4. Connect the digital multimeter to the test points shown in the table below and adjust the relevant resistor for $0.000 \text{ Vdc} \pm 0.001 \text{ Vdc}$.

Model	Test Point	Adjustment
8656B	A10 TP7	A10 R38
8657A	A10 TP6	A10 R38
8657B	A11 TP3	A11 R17

Adjustment 21

DC FM OFFSET ADJUSTMENT

- Service Sheet 7

Description

The DC Offset of the FM Deviation Amplifier is adjusted for an output frequency error of +10 Hz with DC FM selected.

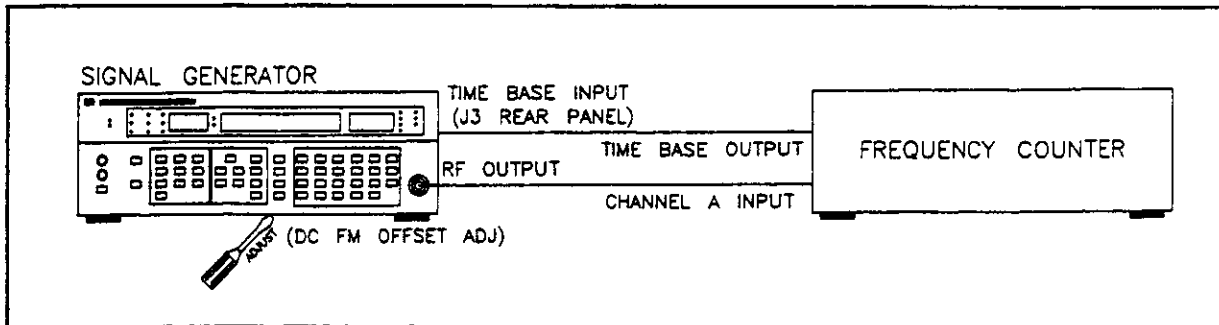

Figure 5-34. DC FM Frequency Offset Adjustment Setup

Equipment

- Frequency Counter HP 5328B
- Adapter, N(m) to BNC (f) HP 1250-0780
- Cable, BNC (2 EA)..... HP 10503A

NOTE

The A3 Assembly must be fastened to RFI cover (MP22) with hex nuts and the A11 Assembly fastened in the instrument before making the DC FM Adjustment.
Voltage Offset Adjustment (Adjustment 20) must be performed before performing this adjustment.

Procedure

1. Set the frequency counter as follows:
 - Frequency Input A
2. Set the Signal Generator as follows:
 - Frequency 65 MHz
 - Amplitude 0 dBm
 - Modulation DC FM, 99 kHz

3. Connect the Signal Generator RF OUTPUT to the frequency counter CHANNEL A INPUT and the counter time base OUT to the Signal Generator Time Base INPUT as shown in Figure 5-21.
4. Adjust the relevant DC FM OFFSET ADJ as shown on the following table, for a frequency counter reading of $65.000000 \text{ MHz} \pm 10 \text{ Hz}$.

Model	Adjustment
HP 8656B	A10R52
HP 8657A	A10R52
HP 8657B	A11R20

Adjustment 22

FM IN-BAND GAIN ADJUSTMENT

- Service Sheet 15

Description

An external modulation signal whose frequency is outside the Low Frequency Loop bandwidth is used to frequency modulate the Signal Generator. The frequency modulation is measured with the EXT FM of the Signal Generator set to 50 kHz for a reference. The external modulation signal is changed to 100 Hz and the FM IN-BAND GAIN is adjusted for the same FM peak deviation.

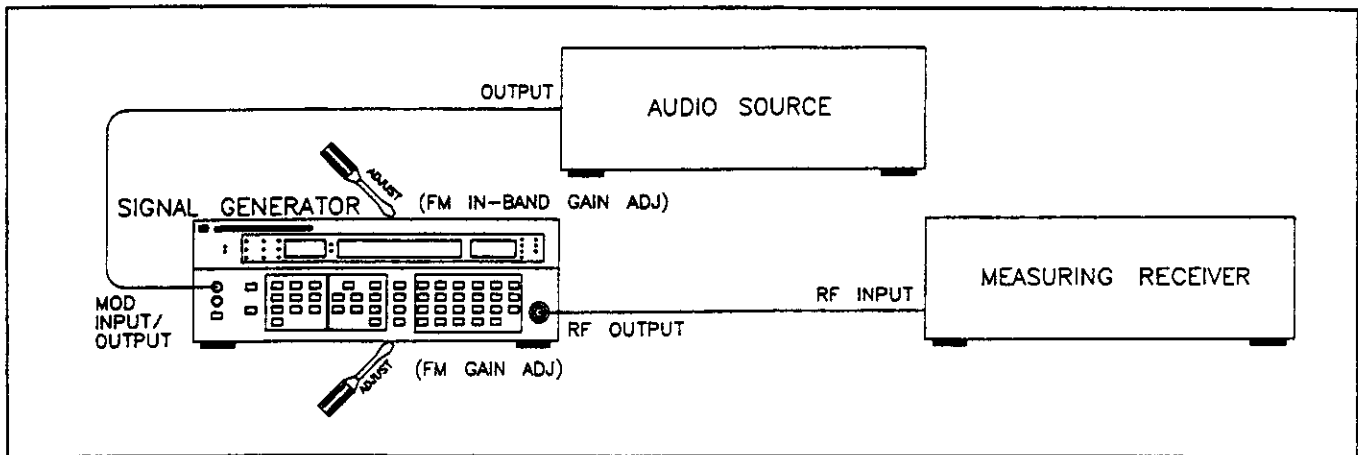

Figure 5-35. FM In-band Gain Adjustment Setup

Equipment

Measuring Receiver	HP 8902A
Audio Source	HP 8903B
Cable (50 ohm coax, UG-21D/U type N(m) connectors)	HP 11500A
Cable, BNC Connectors	HP 10503A

Procedure

1. Set the measuring receiver as follows:

Measurement

FM, PEAK+

2. Set the audio source as follows:

Frequency

20 kHz

Amplitude

1.414 Vac

3. Set the Signal Generator as follows:

Frequency

65 MHz

Amplitude

0 dBm

Modulation

EXT FM, 50 kHz

4. Connect the Signal Generator RF OUTPUT to the measuring receiver INPUT, and the Signal Generator MOD INPUT/OUTPUT to the audio source OUTPUT as shown in Figure 5-35. The Signal Generator LO EXT and HI EXT LED's should be out. Also insure that the Signal Generator INT 1 kHz modulation source is turned off.
5. Adjust the relevant FM Gain ADJ (if necessary) as shown on the following table, for a reading of 50.0 ± 0.2 KHz on the measuring receiver.

Model	Adjustment
HP 8656B	A10R39
HP 8657A	A10R39
HP 8657B	A11R16 A11R25

NOTE

If an adjustment is necessary, the FM Deviation (Adjustment 23) must be performed.

6. For the 8657B only, set FM to 20kHz. Adjust A11R25 and A11R16, for a reading of 20.0 ± 0.2 KHz on the measuring receiver. Repeat steps 5 and 6, until both readings meet the specifications.
7. Set the measuring receiver to RATIO and the audio source frequency to 100 Hz.
8. Adjust A3R723 (FM IN-BAND GAIN ADJ) for a reading of $100\% \pm 0.2\%$ on the measuring receiver.
9. Repeat steps 7 through 9 and readjust A3R723 if required.

Adjustment 23

FM DEVIATION ADJUSTMENT

- Service Sheet 7

Description

The FM deviation is adjusted with a maximum FM peak deviation of 99 kHz entered into the Signal Generator. The carrier frequency is stepped down in 10 MHz steps from 990 to 940 MHz and FM GAIN is adjusted for an equal error around 99 kHz deviation.

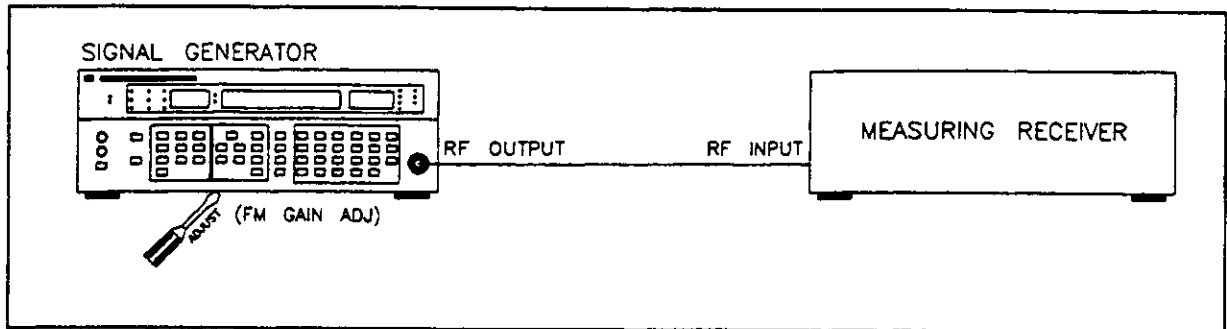

Figure 5-36. FM Deviation Adjustment Setup

Equipment

Measuring Receiver HP 8902A
 Cable (50 ohm coax, UG-21D/U type N (m) connectors) HP 11500A

Procedure

1. Set the measuring receiver as follows:

Measurement FM
 Detector +Peak
 HP Filter 300 Hz
 LP Filter 3 kHz

2. Set the Signal Generator as follows:

Frequency 970 MHz
 Frequency Increment 10 MHz
 Amplitude +4 dBm
 Modulation FM 99 kHz
 Source 1 kHz (Int.)

3. Connect the measuring receiver input to the RF OUTPUT connector on the Signal Generator.

4. Adjust the relevant FM GAIN ADJ as shown on the following table, for a 99.0 kHz deviation reading on the measuring receiver.

Model	Adjustment
HP 8656B	A10R39
HP 8657A	A10R39
HP 8657B	A11R16

5. Step the frequency down from 990 to 940 MHz and record the deviation at each of the 10 MHz steps. Each frequency must be keyed into the measuring receiver.
6. Readjust FM GAIN ADJ for equal error ± 2 kHz from 99 kHz at the frequencies of maximum and minimum peak kHz deviation.

_____ 990 MHz

_____ 980 MHz

_____ 970 MHz

_____ 960 MHz

_____ 950 MHz

_____ 940 MHz

7. The formula of $(\text{Max} - \text{Min})/2 + 99$ kHz equals the calibration point for the carrier frequency with maximum FM deviation.

Adjustment 24

OPTION 001 10 MHZ REFERENCE OSCILLATOR FREQUENCY ADJUSTMENT

- Service Sheet 25

Description

The Option 001 10 MHz Reference Oscillator frequency is adjusted to $10.000 \text{ MHz} \pm 10.0 \text{ Hz}$ using a frequency counter.

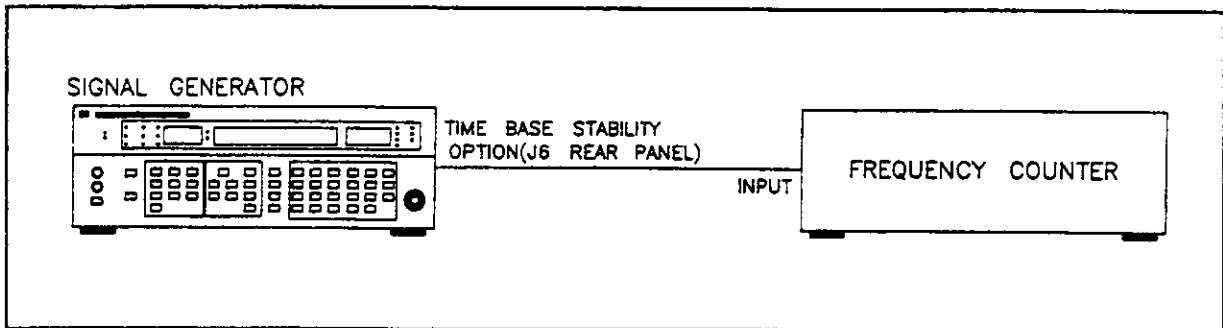

Figure 5-37. 10 MHz Reference Oscillator Frequency Adjustment Setup

Equipment

Frequency Counter HP 5328B

NOTE

Before making the adjustment, the Signal Generator must be warmed up for a minimum of 24 hours.

Procedure

1. Remove the COARSE and FINE screws on the oscillator cover (accessed through the rear panel).
2. Connect the frequency counter to the TIME BASE HIGH STABILITY OPTION connector (J6) on the rear-panel of the Signal Generator.
3. Adjust the COARSE and FINE adjustments for a reading of $10.000 \text{ MHz} \pm 10 \text{ Hz}$ on the frequency counter.
4. Replace the COARSE and FINE screws.

Figure 5–38. Adjustment Locations

